





THE
PUBLICATIONS
OF
The Harleian Society.

ESTABLISHED A.D. MDCCCLXIX.



Volume II.

FOR THE YEAR MDCCCLXX.

TAYLOR AND CO., PRINTERS,
LITTLE QUEEN STREET, LINCOLN'S INN FIELDS.

The Visitation of the County of
Leicester

In the Year

1619.

TAKEN BY

WILLIAM CAMDEN

Clarenceux King of Arms.

EDITED BY

JOHN FETHERSTON, F.S.A.

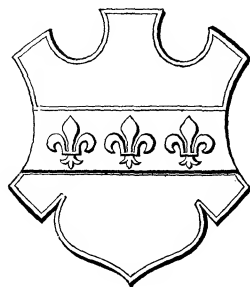

LONDON :

1870.

At a Meeting of the Council of the HARLEIAN SOCIETY, held at 8, Danes Inn, London, W.C., on the 22nd day of November, 1869, JOHN MACLEAN, ESQ., F.S.A., in the Chair, it was resolved that—

“The Second Publication of the Society be THE HERALDIC VISITATION OF LEICESTERSHIRE IN 1619, by William Camden, Clarenceux King of Arms; to be edited by JOHN FETHERSTON, ESQ., F.S.A.”

Preface.

THE Visitation comprised in the ensuing pages was taken by William Camden, Clarenceux King of Arms, in 1619, Sampson Lennard and Augustine Vincent being his deputies, by the former of whom it was in great part written, and whose arms are stamped upon the cover. The pedigrees registered in it are nearly all marked with crosses of red chalk or blacklead pencil, signifying that they were copied from hence for the use of the heralds. Since the book was written, several entrances and insertions have been made by other persons. At fo. 4 is an erroneous pedigree of Cater, put down by Henry Parker. At fo. 42 are the arms of Sir Arthur Haselrigg as they were marshalled A.D. 1644, tricked also by the same Henry Parker. At fo. 56 will be found the following "Account of the Fees and Rewards given to the Officers of Arms, 24th March, A.D. 1619, by Prince Charles and several Lords at their first Entrance into the Tilt Yard":—

"Prince Charles for his first entring into the Tilt gaue to the Kings of Armes Heralds and Pursuivants of Armes twelue scarffes of his colers being those colers, nine yards a peece, of rich taffata, fringed wth deepe golde fringe, and to euerie one a white beuer hat wth siluer bands and feathers of his coulors. and twentie pounds in monie the 24. of March 1619. and all brought him into the tilt yeard from Somerset house the 24. of March afforesaid 1619.

"The Marquesse Buckingham gaue the same time 1619 for his entrance into the tilte twentye markes in monie to the officers of Armes but no coulors bycause all the companie did attend the Prince.

"The Marquesse Hamilton for his first entrance into the tilt gaue to the officers of Armes twentye marks at the same time but no coulors, bycause none did attend him into the tilt.

"The Earle of Oxford gaue for his first entrance into the tilt the same tyme ten pounds in monie but no coulors.

"The Earle of Salisberie gaue for his first entrance into the tilt the same time 1619 the sume of ten pounds in monie to the officers of Armes and six

yards of taffata sarcenet for two officers of Armes although he had none to attend him.

“The yeare following 1620 the Earle of Lincolne gaue for his first entrance into the tilt to 4. officers of Armes 6 yards of taffata sarcenet a peece and ten pounds in monie who brought him from the muse into the tilt & gaue them also fethers of his colour.

“The Lord Compton sonne to the Earle of Northampton gaue to 4 officers of Armes 3^{li} a peece in monie to buy them scarffs of his colours & 20^s to buy them feathers of his coulers and vj^{li} xiijs^s iiij^d as a fee to the whole companie w^{ch} foure did attend him from the muse into the tilt the 24 of March 1620.

“The yeare following 1621 the Viscount Mansfeild gaue to 3 officers of Armes 3 pounds a peece to buy them scarffes of his colours and viij^{li} in monie as a fee to the whole companie But through the fowle wether the daye being twice putt of. In the end the King would haue no tilting that yeare.

“The lord Stanhop the same time 1621 gaue to 3. officers of Armes 3. pounds a peece to buy them scarffes of his colours & vi^{li} xiijs^s iiij^d in monie to y^e whole companie, But ther was no tilting that yeare by reason of the fowle weather as is aforesayd.

“The Lord Montioye of Ireland gaue for his first entrance into the tilt the same time 1621 scarffes of taffata sercenet for 3. officers to bring him into the tilt and vi^{li} xiijs^s iiij^d in monie to the whole companie but nothing was done that yeare by reason of the fowle weather as afforesaid, yet they all had the monie before hand, and the scarffes.”

At (fo. 77, pencil,) will be found inserted an escocheon of Sir Beaumont Dixie, second Baronet of Market Bosworth, impaling the arms and quarterings of his wife Mary, the sister and sole heiress of Sir William Willoughby, Baronet, of Selston, co. Notts. Only one original subscription is to be found, that of “Wylliam Noell,” at fo. 5 b; but in Harl. MSS. 1195 (from fo. 72) is a number of the original loose sheets, signed by those who gave the information for the Visitations of Leicestershire and Warwickshire, and facsimiles of forty-four signatures of the county of Leicester are appended to this work. Several pedigrees have been continued, chiefly by the hands of Henry Parker and Robert Fisher, arms painter, whose autograph is to be seen on the first page. One Richard Mundy, who perhaps accompanied the heralds at this Visitation, seems to have tricked the arms and seals used by the Corporation of Leicester, and to have entered the descent of Wellesborough; that of Beaumont at fo. 34 is in the hand of Augustine Vincent. All these additions, and words written in pencil, are distinguished from the original entries by being in Brevier type. The headings of pedigrees *within*

brackets are so written in the original manuscript ; those *without* have been supplied.

The first Visitation of the County of Leicester was that of Harvey in 1563, by Robert Cooke, Chester Herald. A copy of this, written narratively, is in the national collection (Add. MS. 17,065, fo. 125) and contains the following pedigrees :—

“The dessent of Robert Brokesby of Sholesby in the . . . of Leycester. And in the hondreth of Goscott.”

Of “ Henry Kebyll of Homerston.”

“ John Danvers of Swythland.”

“ George Sherard of Stapullford.”

“ John Ashbye of Lowesbye.”

“ Will'm Peche of Kingthorpe.”

“ Edmond Wynter of Wordington.”

“ Thomas Graye of Langlaye.”

“ Thomas Rosse of Ingmanthorpe.”

“ Thomas Ffarnham of ”

“ Will'm Lacye of Melton Mowbraye.”

“ Ffrauncys Cave of Baggrave.”

“ Bryan Cave of Ingusbye.”

“ Morrys Barklaye lord of Womandham.”

“ George Pochen of Barkbye.”

“ Nicholas Sevyll of Blabye.”

“ Richard Turvyll of Normanton Turvoyle.”

“ John Nowell of Wellesborow.”

“ S^r Thomas Nevyl Knight lord of Hoult & Roliston.”

“ Will'm Skevington of Skevington.”

“ George Vincent of Pekleton.”

“ Robert Belgrave.”

“ George Pureffey of Dreyton.”

Two others are in the College of Arms, also narratively written, the one marked G. 11, the other by Turpin H. 12. There is likewise a book of pedigrees from Cooke's Visitations of Somerset, Warwick, and Leicester, marked F. 7.

A small volume in the possession of the Honorary Treasurer of the Harleian Society is worthy of note, since it gives some information relative to the quarterings of Leicestershire families at this period, and calls attention to a collection of genealogical manuscripts, collected by Henry Ferrers, not one of which unfortunately now remains in the possession of his lineal male heir at Baddesley Clinton.

“ The Armes and the names
of Knigtes Esquyres and

Gentilmen within the Coun-
tie of leicester liuing in y^e
yeere of our lord God
1564

Sett oute as it was performed by Robarte
Cooke then Chester herauld of armes,
the originall (that this was
Copied forth of) was
doun on vellam in
Coullers being in the hands
of Henrie fferrers
of baddisley Clin
ton in Warwik
shire 1593.

In the British Museum, in addition to the manuscript printed here, are others of the second Visitation (1619):—

Harl. MSS. 6125.
6183.
1431.

1187, bound up with the Visitation of Northamptonshire in
1618, beginning at fo. 97, (pencil,) and extending
with alphabetical index to the end of the book,
and 1189, which commences with a list of names and trickings
of arms of justices of the county of Leicester in 1601.

The Library of the College of Arms has two copies:—C. 8, containing about one hundred and twenty-eight pedigrees; and Vincent's Leicester, No. 127. Leicester Visitations are also preserved in both Universities:—Caius College, Cambridge, MSS. 519; New College, Oxford, MSS. CCCXXX.; Queen's College, Oxford, MSS. LXXXIX.

The third and last Visitation of Leicestershire was taken "by Sir Henry St. George, Knt., Clarenceux King at Arms; begun by Thomas May Chester and Gregory King, Rouge dragon, in Trinity Vacation, 168½, and finished by Henry Dethick Richmond and the said Rouge Dragon in Trinity Vacation following, 1683." It forms one of the series of later Visitations, marked K, in the College of Arms, and consists of about one hundred and forty genealogies. In addition to families already recorded, it introduces many others who had become possessed of property in the county since the year 1619, or whose descents had not been registered in the *earlier* Visitations. The following list, in the order in which they occur, may prove useful:—

Manners (Earls of Rutland).
Crewe.
Hudson of Melton Mowbray.

Pate of Sisonby.
Fullwood of Hemington.
Powell of Belvoir.

Curl of Melton.
Palmer of Melton.
Bowdon of Melton.

Herick of Beaumanor.
 Gery of Stony Stanton.
 Toone of Belton.
 Shenton of Barwell.
 Harpur of Bilston.
 Paget of Barwell and Croft.
 Oneby of Barwell.
 Rooe of Normanton Turvile.
 Capper of Burbage.
 Sacheverell of Rearsby.
 Welles of Thrussington.
 Verney of Allextou.
 Andrewes of Great Bowdon.
 Allington of Burbage.
 Hewet of Dunton Basset.
 Palmer of Onlip.
 Dixwell of Coton.
 Edwards of Kibworth.
 Packe of Prestwold.
 Wileman of Burton.
 Lister of Thorpe Arnold.
 Calcott, *alias* Caldecott, of
 Catthorp.
 Greene of Rylston (Rolleston).
 Cole of Lutterworth.

Street of Halloughton.
 Billers of Leicester.
 Palmer of Osgathorp.
 Alefounder.
 Burrough of Burrough.
 Wilson of Knighthorp.
 Maior of Leicester.
 Barwell of Garradon.
 Roby of Castle Donnington.
 Rayson of Barrow upon Soar.
 Wright of Barwell.
 Bradgate of Ullesthorp.
 Byerley of Belgrave.
 Henslie of Lutterworth.
 Briggs of Hinckley.
 Hill of Netherseale.
 Bate of Ashby-de-la-Zouch.
 Woodcock of Cayham.
 Smart of Ashby-de-la-Zouch.
 Staunton.
 Stephens of Leicester.
 Estwick.
 Mordaunt of Medborn.
 Boothby of Marston.

Levinge of Shepey.
 Firebrace.
 Stanley.
 Street of Orton-sup'-Monte'
 (Orton-on-the-Hill).
 Thickbrome.
 Bodle of Markfield.
 Hayes of Burton-Lazers.
 Pratt of Cotesback.
 Holland of Waltham-on-y^e-
 Wolds.
 Saunders of Foxton.
 Bradgate of Peatlin.
 Harley of Osgathorp.
 Wodland of Medborn.
 Sergeant of Melton-Mowbray.
 Hacket of Abkettleby.
 Bennet of Welby.
 Goodall.
 Hilton of Billinghamurst.
 Leek of Wymeswold.
 Cox.
 Clerk of Hoby.
 Whatton.

The Editor begs to acknowledge his great obligation to John Davidson, Esq., for the very elaborate and useful Index attached to this Volume.



ERRATA.

- BERKLEY OF WYMONDHAM (page 2).
- Quartering 1.—To *Gules, a chevron between ten cinquefoils argent*, add *six in chief and four in base*.
- NOELL OF DALBY (page 3).
- Quartering 4.—For *trumpets*, read *organ-pipes*.
- SKEUINGTON (page 7).
- Quartering 11.—For *at the top*, read *in dexter chief*.
- SHERARD OF STAPLEFORD (page 10).
- Quartering 2.—In the MSS. the drawing resembles *trefoils*, but the Arms of Hawberk are *on a bend nine annulets, three, three, and three, interlaced in triangle*.
- EUERARD OF SHENTON (page 12).
- “*Sup Cathedra’ in Domo Ricci’ Euerard de Shenton,*” read *impaling argent, on a fess between three bears’ heads erased sable, muzzles (uninctured), as many bezants*.
- HASELRIG OF NOSELEY (pages 15 and 16).
- Quartering 5.—For *Bendy of six gules and argent*, read *Gules, three bendlets argent*.
Omit mark of descent to “Dorothy, sister to the Lord Brooke.”
- DIGBY (page 40).
- Quartering 6.—Read *Argent, on a fess between three martlets sable as many mullets of the field*.
- BROKESBY (page 49).
- Quartering 4.—Read *Or, a bend gobonée argent and azure between three torteaux*.
- HUMPHREY (page 62).
- Omit mark of descent from *Sir Tho. Humphrie of Shipson in Com’ Leyc. and Mary Da. of Wm Meringe of Meringes in com’ Northam*.
- POULTNEY (page 70).
- Quartering 4.—For *Barry of six*, read *eight*.
Quartering 5.—For *fess*, read *chevron*.
- SHERRARD (page 88).
- Quartering 2.—For *three trefoils*, read *nine annulets, three, three, and three interlaced in triangle* (as at page 10).
- NOBLE (page 114).
- Quartering 2.—After *barry*, read *nébulée*.
- CAVE (page 120).
- Omit mark of descent to “Phillippa fil. unica hæres Rob’ti Braham de Barrow sup’ Sore.
- CAVE (page 125).
- Mark of descent should be to *Maria fil. et hæres Alexandri Caue militis*, instead of to her husband, *Sir Alexander Lounde, Kt.*, etc.
- CARRINGTON, *alias* SMITH (page 145).
- Quartering 4.—For *a . . . ?*, read *a lymphad*.
- CHIPPINGDALE (page 157).
- Arms.—After *erased*, omit *paleways*.
- GILBERT (page 189).
- After *broken spears*, read *erect*.
- BABINGTON (page 205).
- Crest.—After *vere-mouse*, omit *in pale affrontée displayed*.

NAMES OF QUARTERINGS AND IMPALEMENTS
TRICKED IN THE VISITATION OF LEICESTER, 1619.

BERKLEY OF WYMONDHAM
(p. 2).

1. Berkley.
2. Hamelyn.
3. De la Laund.
4. Welles.
5. Engaine.
6. Waterton.

NOELL OF DALBY (p. 3).

1. Noell.
2. Hopton.
3. Heaven.
4. Downton.
5. St. Ouen.
6. Tirrell.

STARESMORE OF FROLESWORTH
(p. 5).

1. Staresmore.
2. Partridge.
3. Willoughby (Burton's
Leic. N. window of
chancel of Frolles-
worth church, ed.
1767, fo. 102).
4. Wolfe.
5. Comberford.
6. Staresmore.

SKEFFINGTON (p. 7).

1. Skeffington.
2. Oldbeef.
3. English.
4. Stanhope.
5. Maulovell.
6. Rochford.
7. Lisle.
8. Jenney.
9. Doiley.
10. Cambridge.
11. Downe.
12. Childe.
13. Colsell.

SHERRARD OF STAPLEFORD
(p. 10).

1. Sherrard.
2. Hawberk.
3. Woodford.

SHERRARD—*continued*.

4. Brabazon.
5. Foluile.
6. Helwell.
7. Brow.
8. Woodvile.

EVERARD OF SHENTON
(p. 12).

1. Everard.
2. Waterton.
3. Grimsby.
4. Moton.
5. Basset.
6. Colvile.
7. Malory.
8. Bugg.
9. Champaine.

ASHBY OF QUENBY (p. 13).

1. Ashby.
2. Mallet?

ASHBY OF LOSEBY (p. 14).

1. Ashby.
2. Zouch of Lubbesthorpe
(Nicholls Leic. vol. iii.
fo. 298).
3. Burdet.
4. Houghton.
5. Stapleford.

HASELRIGG OF NOSELEY
(p. 15).

1. Haselrigg.
2. Stanton.
3. Southill.
4. Boiville.
- 5.

LEGARD (p. 19).

1. Legard.
2. Moyne.
3. Whitworth.
4. Wodham.

NEVILL OF HOLT (p. 21).

1. Smith.

NEVILL—*continued*.

2. Laneham.
3. Hinde.
4. Raby.
5. Nevill.
6. Bulmer.
7. Blanchminster.
8. Rolleston.
9. Palmer.
10. Inglebeard.
11. Bishopston.
12. Fencotes.
13. Croftes.

BURDET (p. 23).

1. Burdet.
2. Camvile.
3. Bruin?
- 4.

FAUNT (p. 28).

1. Faunt.
2. Moyne } Harl. MSS.
3. Clairvaux } 1113, fo. 7.

VILLIERS (p. 29).

1. Villiers (modern).
2. Villiers (ancient) (Harl.
MSS. 1113, fo. 7).
3. Pakeman (Notitia An-
glicana, p. 89).
4. Bellers.
5. Howby (Not. Angl.)
(Harl. MS. 1113 calls
it Sellingham).
6. Kirkby.

PURIFOY (p. 32).

1. —
2. Waver.
3. Shireford.
- 4.
5. Whellesborow.
6. —
7. Waver.
8. Shireford.
- 9.
10. Ayott.
11. Bingham.

PURIFOY—*continued*.

12. Charnells.
13. Charnells.
14. Strelley.
15. —

PALMER AND HARECOURT
(p. 39).

1. Pochin.
2. Palmer.
3. Willoughby.

DIGBY (p. 40).

1. Digby.
2. Waleys.
3. Danvers.
- 4.
- 5.
6. Digby.

WINTER (p. 42).

1. Winter.
2. Hardwick.

REPIINGTON (p. 42).

1. Repington.
2. Goldsmith.
- 3.

WHETHILL (p. 44).

1. Whethill.
2. Flanders.
3. Shepey.

NEELE (p. 45).

1. Neele.
2. Sutton.

BROKESBY (p. 49).

1. Brokesby.
2. Sapcot.
3. Denham.
4. Courtenay.
5. Moels.
6. Newmarch.
7. Arches.
8. Francis.
9. Plesington.

VINCENT (p. 50).

1. Vincent.
2. Grimsby.
3. Vullis.
4. Moton.
5. Basset.
6. Colville.
7. Champaine.
8. Bugg.

CHAMBERS (p. 51).

1. Chambers.
2. Dannel.
- 3.
- 4.

DRAPER (p. 52).

1. Draper.
2. Draper.

DRAPER—*continued*.

3. Aucher.
4. Urswick.

TURVILE (p. 53).

1. Turvile.
2. Flamvile.
3. Bugg.
4. Foucher.
5. Champaine.
6. Stanton.

KEBELL (p. 56).

1. Kebell.
2. Etton of Warwicksh.
(Harl. MSS. 1189, f. 3).

BURTON (p. 56).

1. Curteys.
2. —
3. Cotton (Harl. MSS.
1113, fo. 2).
4. Ridware.
5. Hardwick.
6. Lindley (Harl. MSS.
6128, fo. 61 b).
7. Funden.
8. Flanders.
9. Limsey.
10. Ashbrooke.
11. Champaine.
12. Stevens.

HUMPHREY (p. 62).

1. Humphrey.
2. Humphrey.

DANNET (p. 64).

1. Dannel.
2. De la Hay.
3. Belknap.
4. Sudley.
5. Reade.
6. Montfort.
7. Butler.
8. Shareshull.

BROOKE (p. 65).

1. Brooke.
2. Parker of Copenhall.

SMITH *alias* HARRIS (p. 66).

1. Smith.
2. Coe.

BELGRAVE (p. 67).

1. Belgrave.
2. Shipton.
3. Shelton.
4. Glene or Glenfield.
5. Swyke.
6. Chauntrell.

TURPIN (p. 69).

1. Turpin.
2. Kinsman.
3. Tilley.

TURPIN—*continued*.

4. Pawcoe.
5. Gobion.

POULTNEY (p. 70).

1. Poultney.
2. Whymall MSS. (Lu-
cells?).
3. Daniel MSS. (Massy?).
4. Thorpe.
5. Derby.
6. Morley.
- 7.
8. Davall (Ferrers MSS.
penes J. J. Howard).
9. Walshe.
10. Byron.

HASELRIGG (p. 70).

1. Haselrig.
- 2.
3. Heron.
4. Sadington.
5. Martivall.
6. Staunton.
7. Eccleshall.
8. Meynell.
9. Warde } Nicholls Leic.
10. Everden } vol. ii. pt. 2,
p. 753.
11. Entwissell.
12. Gorges (ancient).
13. Gorges (modern).
14. Russell (Falkiners Chel-
sea, p. 235).
15. Oldhall.
16. Inglowese.

HASTINGS (p. 72).

1. Hastings.
2. Pole.
3. France and England
(Clarence).
4. Nevill.
5. Montacute.
6. Monthermer.
7. Holland.
8. Edmund, Earl of Kent.
9. Beauchamp.
10. Newburgh.
11. Spencer.
12. Clare.
13. Wake.
14. Hungerford.
- 15.
16. Moels.

GREY (p. 74).

1. Grey.
2. Hastings.
3. Valence.
4. Astley.
5. Ferrers.
6. Wydvile.
7. Bonville.
8. Harington.

- DANVERS (p. 86).
1. Danvers.
 2. Walcote.
 3. Wallis.
 - 4.
- SHERRARD (p. 88).
1. Sherrard.
 2. Hawberk.
 3. Isley.
 4. Burgh.
 5. Woodford.
 6. Preston.
 7. Brabazon.
 8. Folville.
- YARDE (p. 91).
1. Yarde.
 2. Ferrers (Harl. MSS. 889, fo. 73.)
- SAVILL (p. 93).
1. Savill.
 2. Blaby.
- TURNER (p. 95).
1. Turner } impaling
 2. Masterson } Breton.
- BELGRAVE (p. 95).
1. Belgrave.
 2. Shipton.
 3. Shelton.
 4. Glene or Glenfield.
- PEPER (p. 103).
1. Peper.
 2. Bugg.
 3. Sheffield.
- RUDING (p. 104).
1. Ruding.
 2. Clerke.
 3. Watercroftes.
- POCHIN (p. 106).
1. Pochin.
 2. Willoughby.
 3. Lincoln.
 4. —
 5. Palmer.
 6. Brett.
- SKEFFINGTON (p. 111).
1. Skeffington.
 2. Oldbeef.
 3. Cambridge.
 4. Donne.
 5. Childe.
 6. Colsell.
 7. English.
 8. Lisley (?).
- NOBLE (p. 114).
1. Noble.
 2. Kebell.
 3. Palmer.
 4. Eaton.

- DIXIE (p. 115).
1. Dixie.
 2. Beridge.
 3. Crathorne.
 4. Thoresby } Harl. MSS.
 5. Esterby } 1550, fo's.
 6. Moigne } 190, 53, 174.
 7. Beaumont.
 8. Comyn.
 9. Quincey.
 10. Bellamont.
 11. De Grentesmainil.
 12. Alan, Earl of Gallo-
way.
 13. Scotland (ancient).
 14. Nevill.
 15. Hugh Lupus.
 16. Everingham.
 17. Maureward.
 18. Hastings.
- IMPALING.
1. Willoughby.
 2. Green or Rotherham ?
 3. Pusey,
 4. Clay of Crich co. Derby.
 5. Calton.
 - 6.
 7. Strelley.
 8. Ashton.
 9. Wardell.
- DIXIE (p. 116).
1. Dixie.
 2. Beridge.
- STURTON (p. 119).
1. Sturton.
 2. Cowley.
 3. Smith.
- BURTON (p. 121).
1. Burton.
 2. Curteys.
 3. Cotton.
 4. Ridware.
 5. Hardwick.
 6. Rodvile.
 7. Funden.
 8. Flanders.
 9. Limesey.
 10. Ashbrook.
 11. Champaine.
 12. Stevens.
- PLUMBE, IMPALING FORTESCUE (p. 121).
- CAVE (p. 122).
1. Cave.
 2. Gilliott.
 3. Cliffe.
- CHARNELLS (p. 122).
1. Charnells.
 2. Bereford.

- CHARNELLS—*continued*.
3. Shevesby.
 4. Francis (?).
- DUPORT (p. 123).
1. Duport.
 2. Montague.
- CARRINGTON *alias* SMITH (p. 130).
1. Smith.
 2. Laneham.
 3. Harewell.
 4. Morton.
 5. Woodford.
 6. Preston.
 7. Brabazon.
 8. Rolleston.
 9. Folville.
 - 10.
 - 11.
 - 12.
- ASHBY (p. 132).
1. Ashby.
 2. Mallet ?.
- CROFT (p. 140).
1. Croft.
 2. Harvey.
 3. Burdet.
 4. Willoughby.
- BALE (p. 141).
1. Bale.
 - 2.
- EVERARD (p. 142).
1. Everard.
 2. Everard of Shenton.
 3. Langham.
- BRUDNELL (p. 143).
1. Brudnell.
 2. Atte Grove.
 3. Raan (Harl. MSS. 1095, fo. 35).
 4. Blaket of Castleton, co. Oxon.
 5. Bulstrode.
 6. Knife.
 7. Thorne (Harl. MSS. 1095, fo. 35).
 8. Entwissell.
- CARRINGTON *alias* SMITH (p. 145).
1. Smith.
 2. Laneham.
 3. Raby.
 4. Nevill.
 5. Bulmer.
 6. Blanchminster.
 7. Rolleston.
 8. Palmer.
 9. Inglebeard.

CARRINGTON—*continued*.

10. Bishopston.
11. Fencotes.
12. Croftes.

PECK (p. 146).

1. Peck.
2. Haselden *alias* Carter.

BAGHOT, IMPALING FINEUX
(p. 150).

LASCELLES (p. 155).

1. Lascelles.
2. Burdet?
3. Abbot?

BANISTER (p. 164).

1. Banister.
2. Jakes.
3. Fitzherbert.
4. Clinton.
5. Meignell.
6. Savage.
7. De la Warde.
8. Warden.

TEMPLE (p. 167).

1. Temple.
2. Spencer.

BEAUMONT (p. 169).

1. Beaumont.
2. Comyn.
3. Quincy.
4. Bellamont.
5. Galloway.

BEAUMONT—*continued*.

6. Scotland (ancient).
7. Blondevill.
8. Everingham.
9. Maureward.
10. Hastings.
11. Herle.

LEIGH (p. 173).

1. Leigh.
2. Bagguley.
3. De Corona?
4. Levenshulme.

BERESFORD (p. 178).

1. Beresford.
2. Shevesby.
3. Francis?

EYTON (p. 183).

1. Eyton.
2. Hussey.
3. Derby.

LACY (p. 186).

1. Lacy.
2. Roskin (Harl. MSS. 1189, fo. 3).
3. Beler.

GREGORY (p. 187).

1. Gregory.
2. Asfordby.
3. Segrave.
4. Malyn.
5. Dymock.
6. Marmion?

COTTON.

1. Cotton.
2. Ridware.
3. Falconer.
4. Folville.

CALDWALL (p. 192).

On an escocheon of pretence.

1. Caldwell.
2. Fishwick?

LANY (p. 196).

1. Lany.
2. Coke.
3. Bohun (Harl. MSS. 1560, fo. 85).

ROBERTS (p. 203).

1. Roberts.
 2. Welles, co. Herts (Lysons Environs, Wilsdon).
 3. Pattinson (Harl. MSS. 1551, fo. 124).
- Another, impaling Burnaby.

BABINGTON (p. 205).

1. Babington.
2. Ward.
3. Dethick.
4. Stafford.
5. Beaumont.
6. Everingham.
7. Leventhorp.
8. Heronville.

List of Pedigrees.

	PAGE		PAGE		PAGE
ABNEY	153	BRUDNELL	143	DIGBY	87
ABNEY	154	BURDET	18	DIGBY	199
ALLEN	109	BURDET	23, 24	DIGBYE	40, 41
ALLEN	195	BURTON	56, 57	DIXIE	116
ALSOP	105	BURTON	160	DIXON	195
APLEBY of <i>Apleby</i>	11	CALDWALL	192	DRAPER	52
ARMESTON	176	CARRINGTON <i>alias Smith</i>		DUPORT	123, 124
ASHBY of <i>Quenby</i>	13		130, 131, 132	ELKINGTON	153
ASHBY of <i>Loseby</i>	14	CARRINGTON <i>alias Smith</i>		EUERARD of <i>Shenton</i>	12, 13
ASHBY	132		145, 146	EVERARD	142
ASHTON	198, 199	CATER	1	EVERARD	175
BABINGTON	205, 206	CAVE	120	EYRE	193
BAGHOT	150, 151	CAVE	122	EYTON	183
BAINBRIG	190, 191	CAVE	125, 126, 127, 128	FARMER	179
BALE	141, 142	CAVE	133	FARNHAM	77
BANISTER	164, 165	CHAMBERLAINE	137	FARRENT	202
BANKES	150	CHAMBERS	51, 52	FAUNT	28
BARRET	107	CHARNELLS	122, 123	FOX	149
BAYNBRIGE	181, 182	CHESELDON	107	GEE	180, 181
BEAMONT	60, 61	CHESELTON	20	GERVEIS	71
BEAUMONT 169, 170, 171, 172		CHESTER	138	GILBERT	189
BELGRAVE	67, 68, 69	CHIPPINGDALE	157	GODDARD	190
BELGRAVE	95, 96	COOKE	108	GOODMAN	84
BENT	158, 159	COOPER	90	GORE	85
BERESFORD	178	CORBET	17	GRAY	74, 75
BERKLEY	2	CORBET	48	GREGORY	187, 188, 189
BERY	207	CORBET	177	GREY of <i>Barwell</i>	17
BICKERTON	173	COTES	94	GREY	139
BOTHOM	165	COTTON	191, 192	GRIFFITH	205
BRABAZON <i>alias Woodford</i> 47		COWPER	152	HALFORD	144
BRADSHAW	44	CRADOCK	149	HALFORD	144, 145
BRADSHAW	161, 162	CROFT	140, 141	HALL	204
BRASBRIDGE	43	CUTLER	138	HARCOURT	166
BRETON	161	DANNET	64	HARTOP of <i>Burton Lazars</i> 9	
BRETT	206	DANVERS	86, 87	HARTOP	196, 197
BROKESBY	49	DAWES	98	HASELRIG of <i>Noseley</i>	15, 16
BROOKESBY	201	DERBY	18	HASTINGS	72, 73
BROOKE	65	DETHICK	88	HODGES	154

	PAGE		PAGE		PAGE
HOLLINGWORTH	184	PATE	89	STARESMORE <i>of Froles-</i>	
HUBERT	38	PECHE	65	<i>worth</i>	5, 6
HUMPHREY	62	PECK	146, 147, 148	STARESMORE	99
KEBELL	56	PEPER	103	STARKIE	175
KENDALL	90, 91	PERIN	198	STAVELEY	136
LACY	75	PILKINGTON	78	STRELLEY	194
LACY	166	PLUMBE	121	STURTON	119
LACY	186	POCHIN	106	SWYNFEN	134
LANY	196	PORTE	48	TEMPLE	167, 168
LASCELLES	155	POULTNEY	70	THAME	130
LAWRENCE	27	PRESTWICH	63	TRIMNELL	176
LAWRENCE	102	PURIFOY	32, 33, 34	TURNER	95
LEGARD	19, 20	PURIFOY	35, 36	TURVILLE	53, 54, 55
LEIGH	173, 174	PURIFOY	37	VILLERS	29, 30, 31
MARSHALL	103	REPINGTON	42	VINCENT	50, 51
MARSTONE	101, 102	ROBERTES	117, 118	VINCENT	79
MARTIVALL	129	ROBERTS	203	VINCENT	80, 81
MAY	180	ROBINSON	182	VINCENT	82
MEADE	151	ROOS	92	VOWE	194
MORTON	183, 184	RUDIARD	202	WALKER	137
MOTON	58, 59	RUDING	104	WARD	83
MOUNTNEY	179	SALISBURY	185, 186	WARDE	87
MULSHO	155	SAVILL	93	WARDE <i>alias Farmour</i> 177, 178	
NEALE	163, 164	SEGRAVE	18	WASE	200
NEEDHAM	100	SHARPE	89	WHALLEY	148
NEELE	45, 46	SHERARD <i>of Stapleford</i>	10	WHETHILL	44, 45
NEULL <i>of Holt</i>	21, 22	SHERMAN	203, 204	WHITAPH	98
NICOLLS	187	SHERARD	88	WHITING	92
NOBLE	114, 115	SHIPWARD	82	WIGLEY	97
NOEL <i>of Dalby</i>	3, 4	SHIRLEY	25, 26, 27	WILCOCKES	135, 136
NOEL	113, 114	SKEFFINGTON	110, 111, 112	WINCOLL	156
NOONE	174	SKEUINGTON	7, 8	WINTER	42
OVERTON	193	SMALLEY	76, 77	WOODFORD <i>et Turuill</i>	38
PAGE	63	SMITH <i>alias Harris</i>	66, 67	WRIGHT	152
PALMER <i>et Harecourt</i>	39	STANFORD	160	YARDE	91

The Visitation of the County of Leicester,

TAKEN A.D. 1619 BY SAMPSON LENNARD BLUE MANTLE AND
AUGUSTINE VINCENT ROUGE ROSE POURSUIVANTS,
BEING MARSHALLS AND DEPUTIES TO WILLIAM CAMDEN,
CLARENCEUX. (HARL. MSS., 1180.)

(Cater.)*

ARMS. *Ermine, on a pile gules a lion passant guardant or.*

— Cater of Leicestersh. 1^o Hen. 3. =

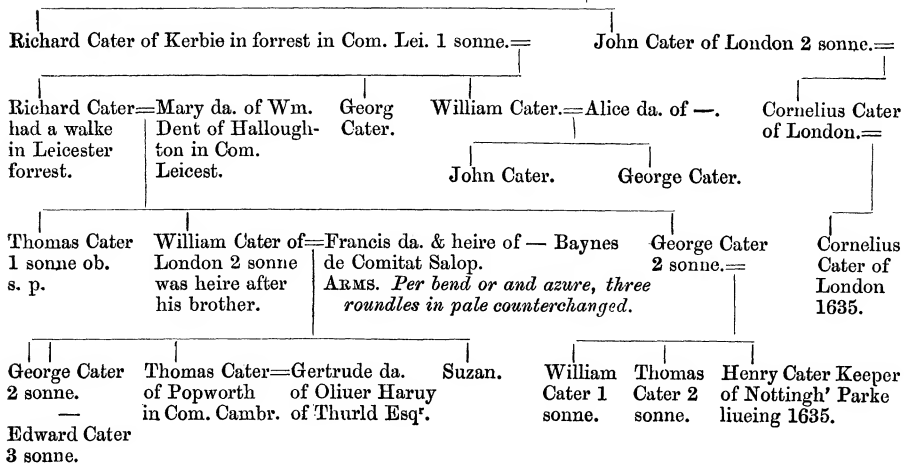

* This erroneous descent of Cater of Leicestershire was put down by Henry Parker.

Berkley of Wymondha' Leye.

ARMS. *Quarterly*:—1. *Gules, a chevron between ten cinquefoils argent.* (BERKLEY.)
 2. *Gules, a lion rampant ermine, crowned or.* (HAMELYN.) 3. *Argent, a fess dancettée between three billets gules.* (DE LA LAUND.) 4. *Or, a lion rampant, double queuee sable.* (WELLES.) 5. *Gules, a fess dancettée between six cross crosslets or.* (ENGAINÉ.) 6. *Barry of six, ermine and gules, over all three crescents sable.* (WATERTON.)

ANOTHER COAT. *Quarterly, a chevron between ten cinquefoils (untinctured); and gules a lion rampant ermine, crowned or.*

CREST. *A bear's head coupéd argent, muzzled gules.*

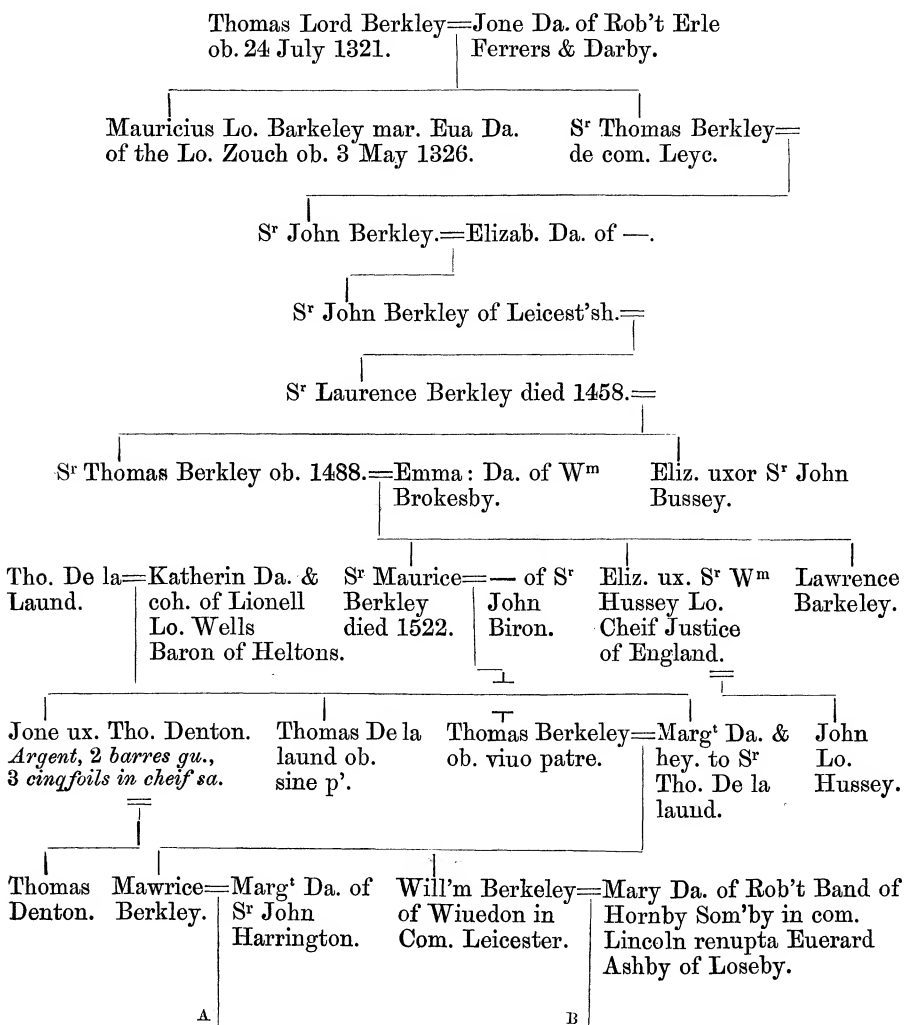

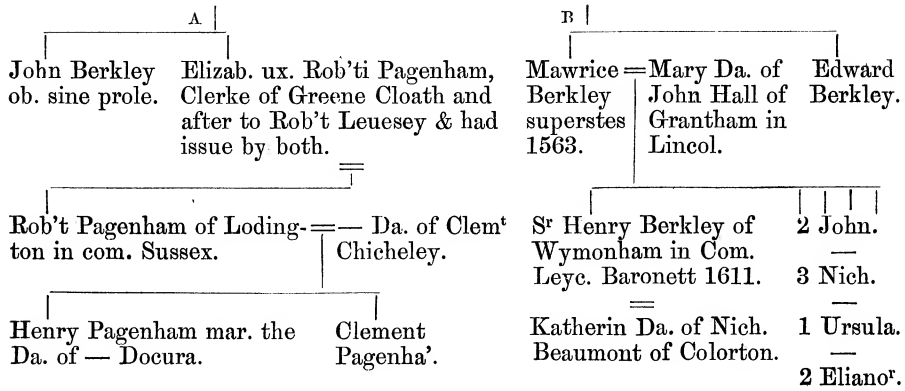

Noell of Dalby Leic.

ARMS. *Quarterly*:—1. Or, fretty gules, a canton ermine. 2. Gules, semée of cross crosslets fitchée, a lion rampant or, charged on the shoulder with a crescent for difference. 3. Azure, three boars' heads argent, between nine cross crosslets or. 4. Azure, two trumpets in pile between nine cross crosslets or. 5. Barry of six, or and gules. 6. Azure, a lion rampant argent within a bordure engrailed or.

CREST. *A buck statant argent, attired or.*

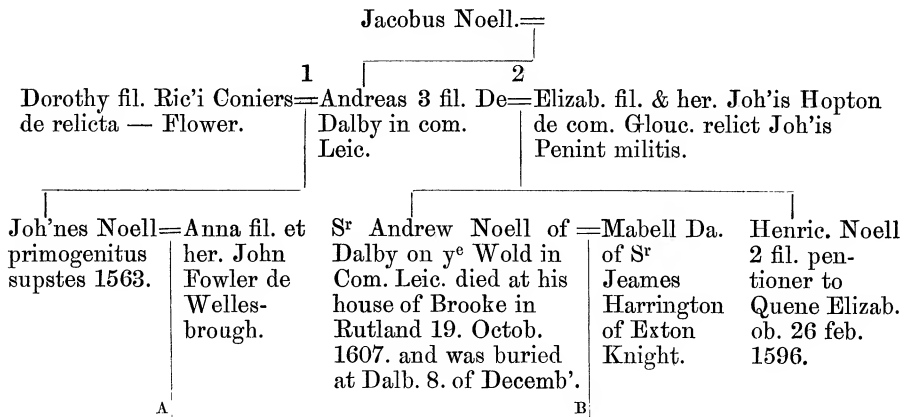

THE VISITATION OF THE COUNTY OF LEICESTER.

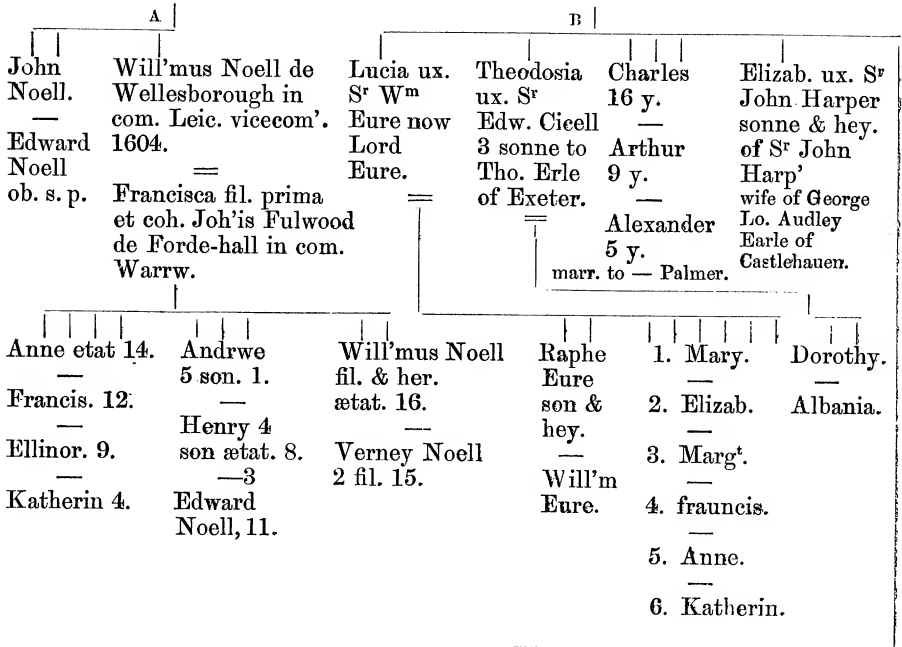

Wylham Noell

Sr Edward Noell sonne & hey. Baronett 1611. created Baron of Ridlington 1617. = Julian eldest Da. of Sr Baptist Hix of London Kt.

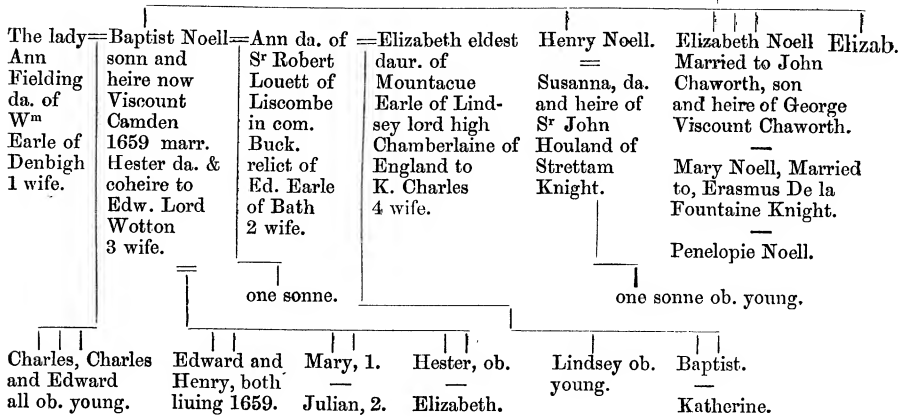

Staresmore of Frolesworth in Com. Leic.

ARMS. *Quarterly*:—1. *Argent, a chevron vert between three torteaux.* (STARESMORE.) 2. *Argent, three partridges gules.* (PATRICH.)
 3. *Gules, a cross moline argent.* 4. *Argent, a wolf salient sable.* (WOLFE.) 5. *Gules, on a cross engrailed or five roses.* (COM-
 BERFORD.) 6. *A fess between three roundles (uninctured).*
 CREST. *A stare or starting proper.*

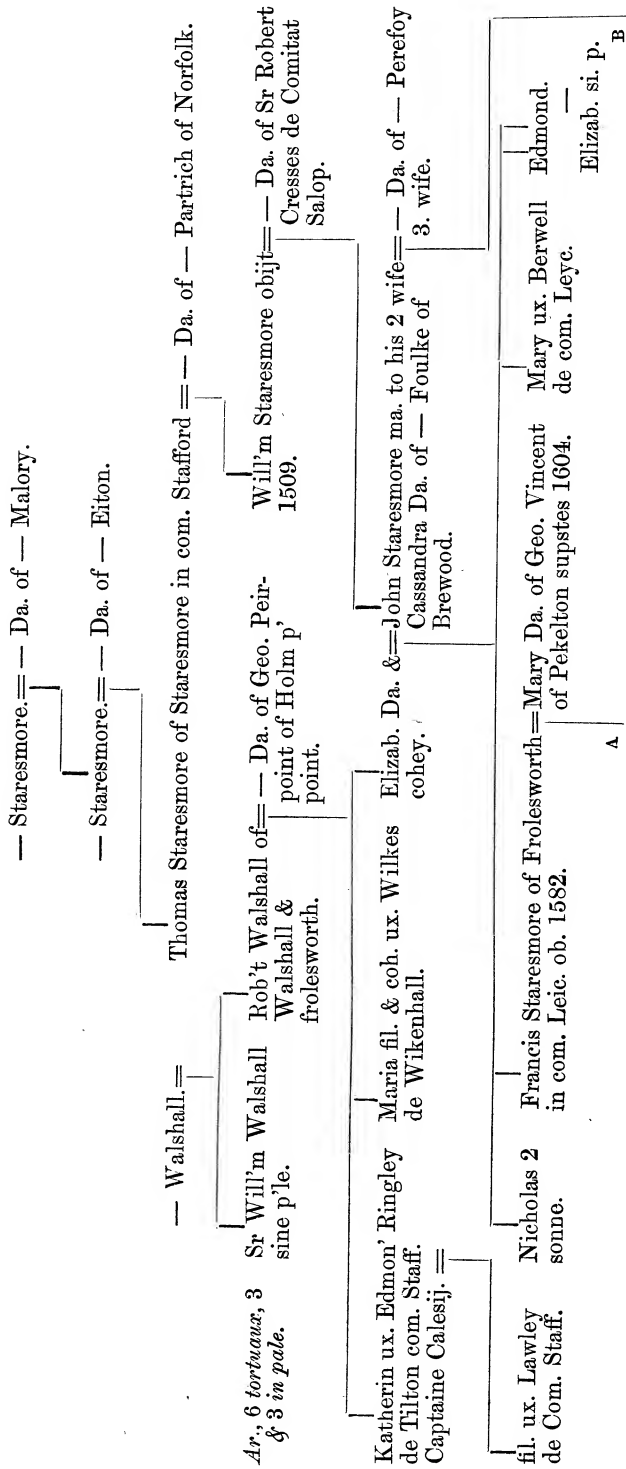

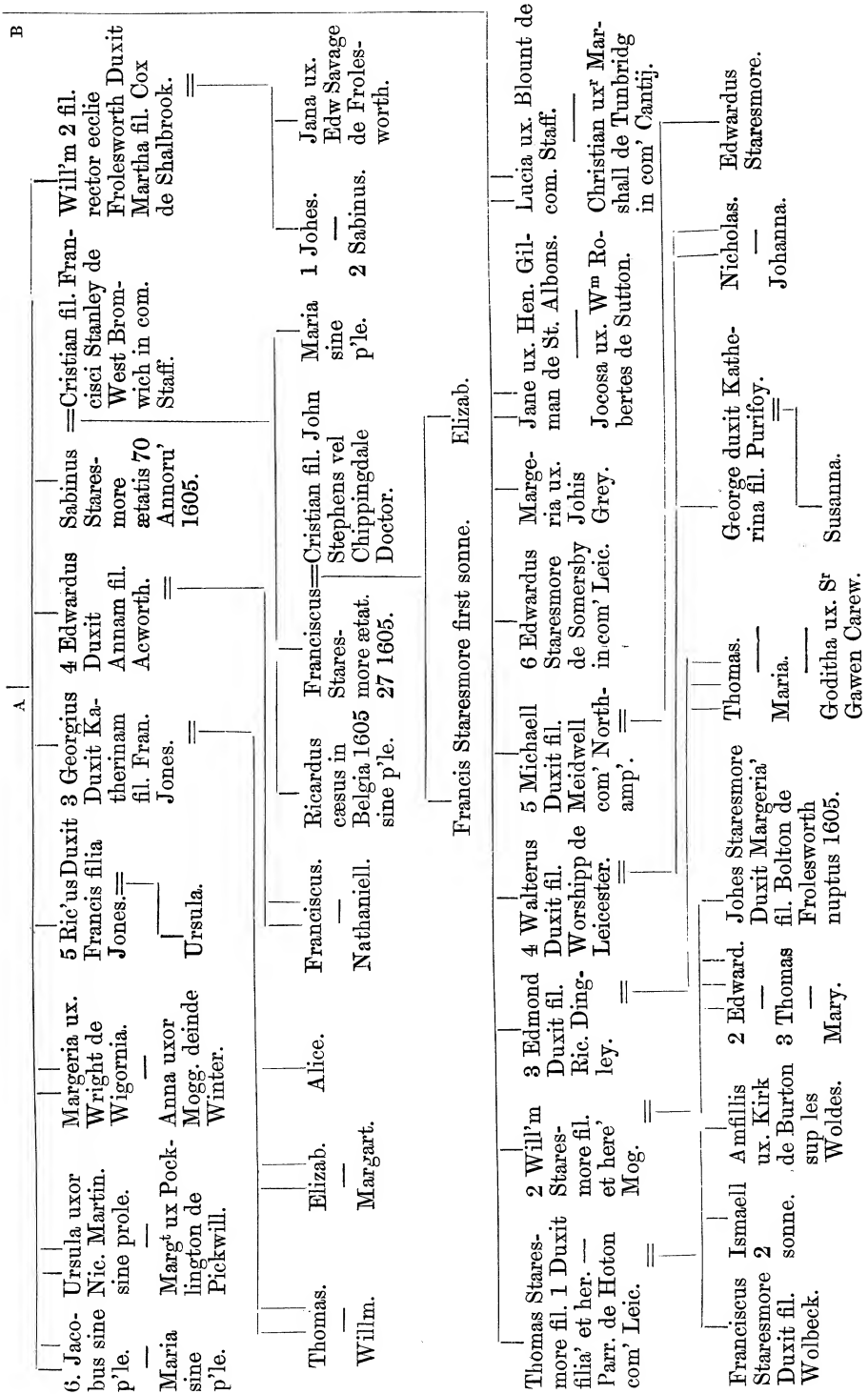

Skeuington.

ARMS. *Quarterly*:—1. *Argent, three bulls' heads erased sable.* (SKEUINGTON.) 2. *Azure, a bend cotised between six mullets or.* (OLDBEIFFE.) 3. *Ermine, a bend azure.* (ENGLISH.) 4. *Quarterly, ermine and gules.* (STANHOP.) 5. *Vert, three greyhounds courant in pale or.* (MALOUELL.) 6. *Quarterly, or and gules within a bordure sable bezantée.* (ROCHFORD.) 7. *Gules, an eagle displayed or.* (LISLEY.) 8. *Argent, three Cornish choughs sable.* (JENNEY.) 9. *Argent, a fess dancettée between three crescents gules.* (DOILEY.) 10. *Sable, three garbs argent.* (CAMBRIDG.) 11. *Azure, a bend or, at the top an annulet gules.* (DOWNE.) 12. *Ermine, on a chief indented gules three escallops or.* (CHILDE.) 13. *Or, a pale azure, a chief vert.* (COLSELL.)

CREST. *A mermaid proper, crined or, holding in the dexter hand a looking-glass of the last, and in the sinister a comb (untinctured).*

Galfridus Skefington de Skefington in com. Leic. mil.

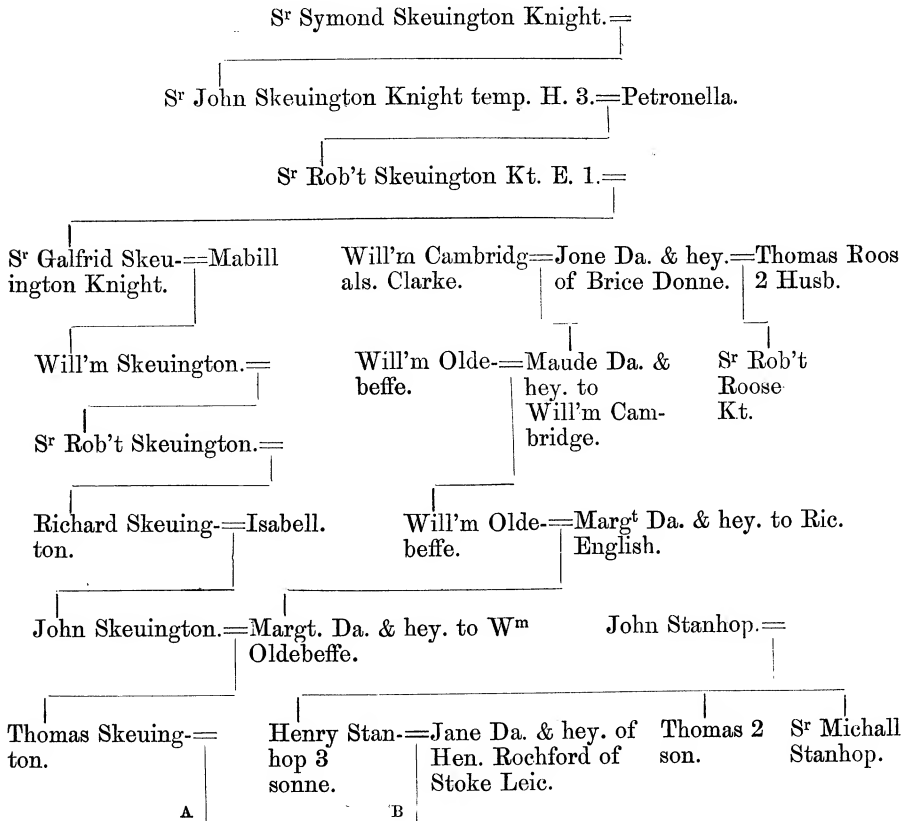

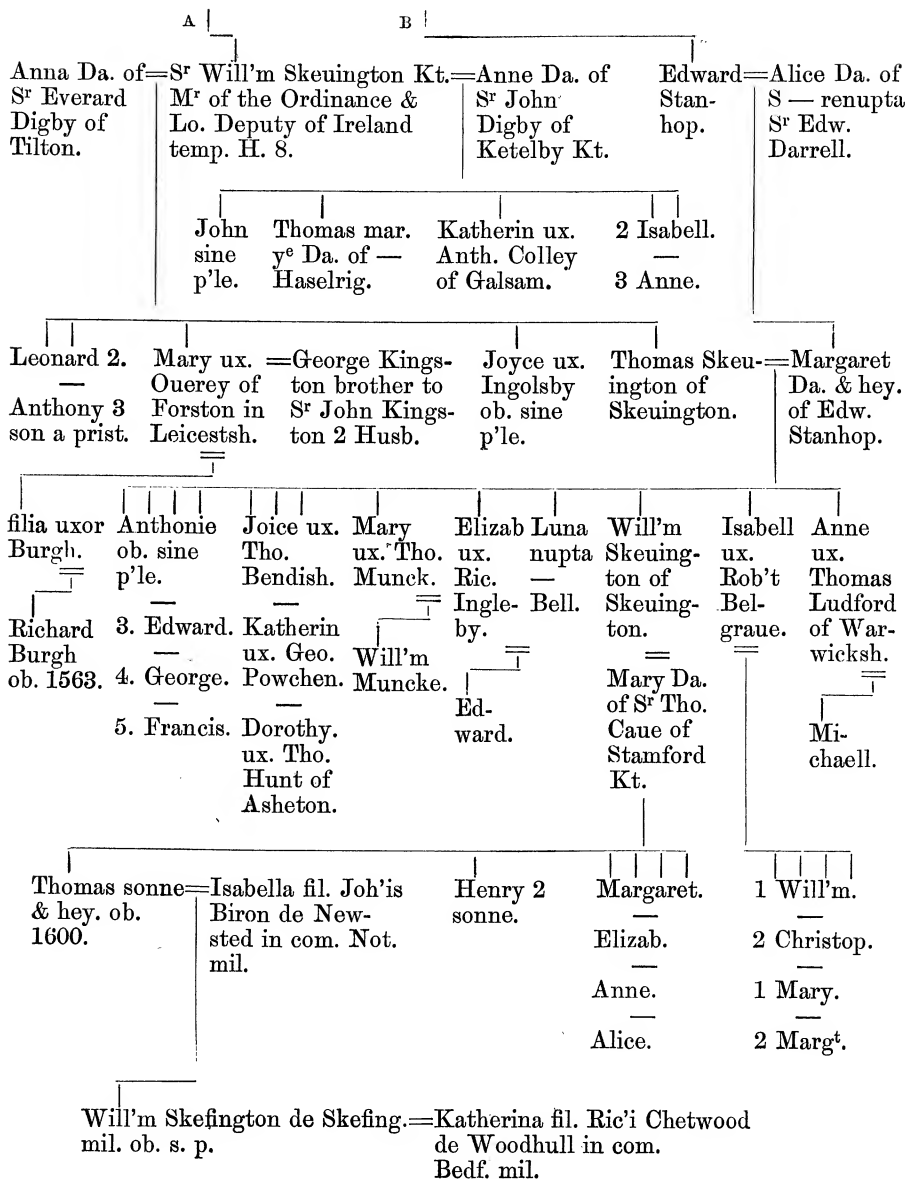

Hartop of Burton Lazars in Com' Leyc.

Raphe Hartop temp. R. 2. = — Da. of Alexander Moyne.

Precilla ux. Oliuer Cooke.	Philippa ux. Geo. Holleys.	Alexander Hartope.	=Ellin Da. of —.	Mariona Da.	Autheria 4 Da.
-------------------------------	-------------------------------	-----------------------	---------------------	----------------	-------------------

John Hartop = Margaret Da. of Thomas Brideamaine.	Mary mar. to Hen. Leibourne Esq.
--	-------------------------------------

John Hartop 2 sonne mar. Cristian Da. of John Williams.	Henry = Barbara Da. of Hartop. Raphe fitz Randall.	Marg ^t eldist Da. mar. to Thomas Broxby.	Ursula mar. to John Ashley.
---	--	---	-----------------------------------

Rob't Hartop 2 son mar. Anne Da. of John Porter of Betton.	John Hartop = Jane Da. of W ^m Inglebeard.	Isabell mar. to Thomas Blasbye.
---	---	------------------------------------

Richard Hartop = — Da. of Raph Chamberlayne.	John Hartop mar. Grace Da. of Will'm Blewet.
---	---

Thomas Hartop = — Da. of John Allen.

Joane mar. to Octavian Fisher of Threkingham in Com. Lincoln.	Will'm = Elliano ^r Da. Hartop. & hey. of — Adcot postea ux. — Odingselles.	Valentine = Anne Da. & Hartop hey. of 2 son. Will'm Goodman Com. Leyc.	Richard student of the middle Temple ob. sine prole.
--	---	--	---

Judith. — Susan. — Elizab. — Anne.	4 Richard. — 5 Georg.	Valentine Har- top 2 sonne mar. the Da. of — Pratt of Lutterworth in Com. Leic.	Edward = Mary Da. Hartop of Eras- mus Dry- den de Ashby in Com. Northam'.	Thomas = — Da. of Hartop Tho. Caue first son. of Stan- ford in Com. Northam.
--	-----------------------------	--	---	---

Sr Will'm Hartop of Burton Lazars in Com. Leic. Kt.	= Mary Da. of John Rolt of Milton Herneis in Com. Bedford.	Samuell Hartop 2 son: mar. Briget Da. of W ^m Mason of Egmondton in com. Nott.	Mary mar. to Nic. Stringer of Eaton in Com. Nott.	Elizab. mar. to Geo. Bale of Carlton Curlew in Com. Leic.	Jone mar. to W ^m Stret of De Com. Leic.
--	--	---	---	---	--

Thomas son & hey.

Sherard of Stapleford in Com. Leyc.

ARMS. Quarterly:—1. *Argent, a chevron between three torteaux.* (SHERARD.) 2. *On a bend three trefoils slipped (untinctured).* (HAUBERK.) 3. *Argent, three leopards' heads jessant-de-lis sable.* (WODFORD.) 4. *Ermine, a talbot passant sable.* (PRESTON.) 5. *On a bend three martlets (untinctured).* (BRABSON.) 6. *Per fess argent and or, a cross moline gules.* (FOLUILE.) 7. *Argent, on a chevron sable three bezants within a bordure engrailed gules.* (HELWELL.) 8. *Gules, on a chevron argent three roses of the field.* (BROW.) 9. *Argent, a fess and canton conjoined gules within a bordure bezantée.* (WOODUILE.)

CREST. *On a wreath azure a peacock's tail erect proper, banded chequy argent and gules. On the dexter side is written "pecocks tayle"; on the sinister, "pecocks plum."*

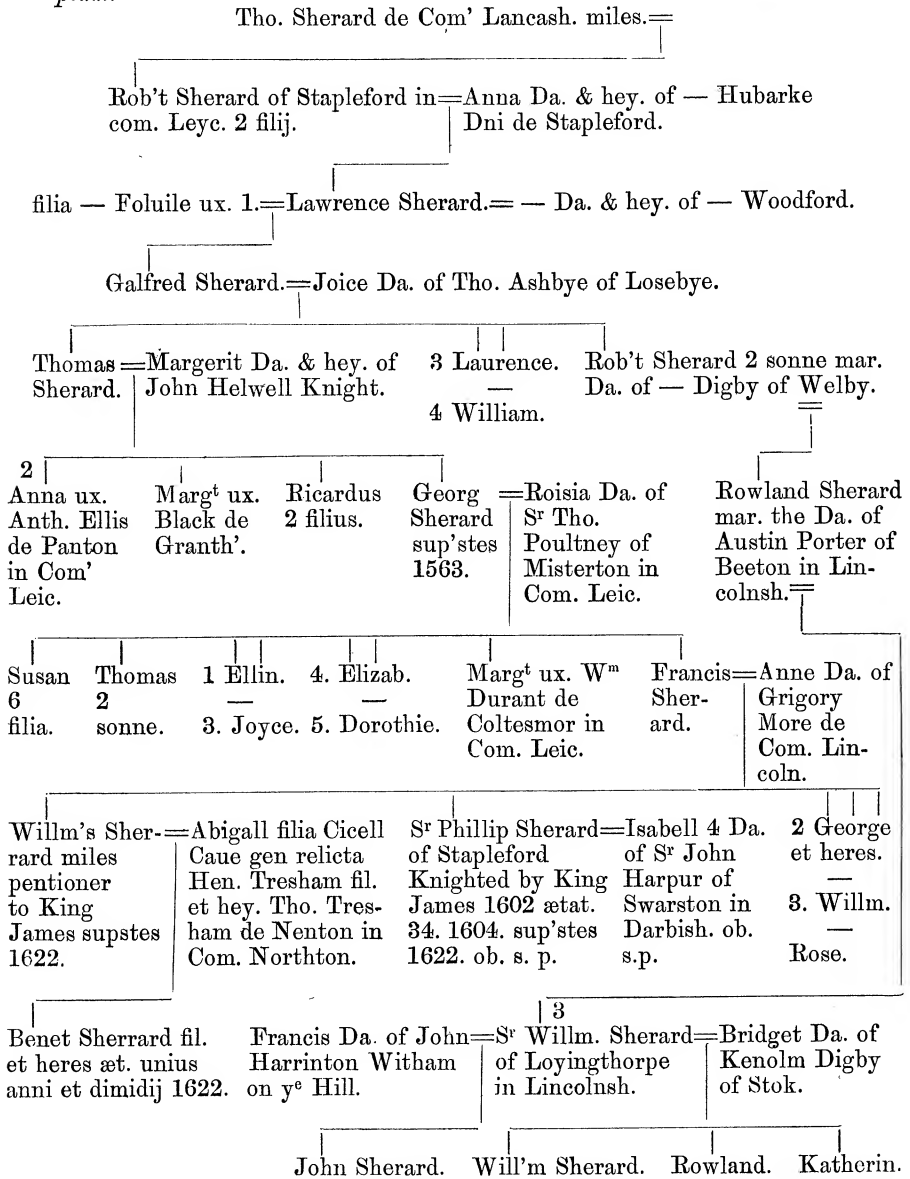

Apleby of Apleby.ARMS. *Azure, six martlets or, three, two, one.*

Henricus Aplebye of Apleby in Com. Leicest.==

Sr Edmond Apleby 53 H. 3.==

Sr Will'm Apleby == Alice ux. John Hardwick of Lindley.

Sr John Apleby 4. & 27. Ed. 3.==

Sr Edmond Apleby.==

Sr John Apleby 1. R. 2. et 6. H. 4.==

Thomas Apleby 5. H. 5.==

Edmond Apleby 21. H. 6.== — Da. & hey. of W^m Pechet. ARMS. *A fleur-de-lis (uninctured).*

John Aplebye.==

Rich. Apleby 21. H. 7. ob. 1528.== Elizab. Da. of Rob't Langham of Gopshill.

George Apleby Slayne at=Muskleborowe feild. Jocosa Da. of Tho. Curson de=Croxhall combusta propter religione' 1557. Tho. Lewes de=Manceter Com' War.

Richard Apleby.==

Francis Apleby 1605. Neuill. Barbara.

Euerard of Shenton in Com' Leic.

ARMS. *Quarterly*:—1. *Gules, on a fess three mullets between as many étoiles argent.* (EUERARD.) 2. *Barry of six ermine and gules, over all three crescents sable.* (WATERTON.) 3. *Barry nebulée of six sable and or, on a chief argent three birds of the first.* (GRIMSBY.) 4. *Argent, a cinquefoil azure.* (MOTON.) *Or, three piles meeting in base gules, a canton vair.* (BASSET.) 6. *Or, a fess gules.* (COLUILE.) 7. *Or, a lion rampant double queuee gules.* (MALORY.) 8. *Or, on a fess three water bougets.* (BUGG.) 9. *Or, fretty (untinctured).* (CHAMPANIE.)

ARMS OF LANGHAM. *Argent, three bears' heads coupéd sable, muzzled or.*

Sup Cathedra' in Domo Rici' Euerard de Shenton.

Gules, a fess nebulée between three étoiles argent, impaling argent, on a fess sable three bezants between as many bears' heads erased, muzzled.

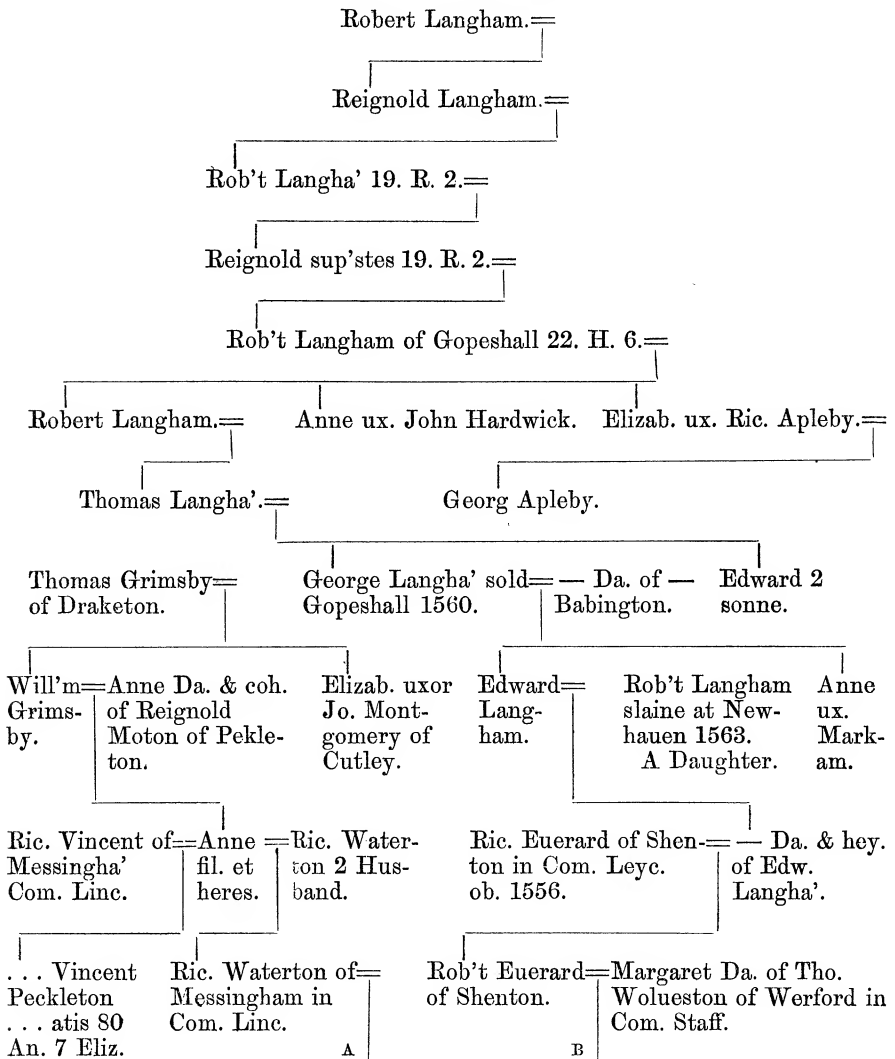

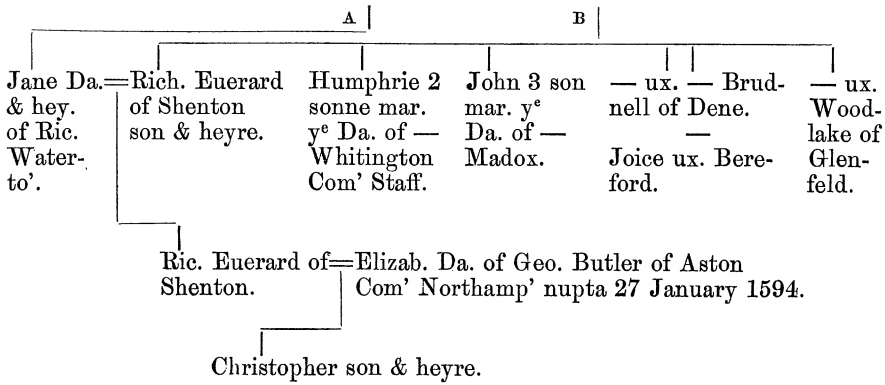

Ashby of Quenby in Com' Leyc.

ARMS. Quarterly:—Azure, a chevron ermine between three leopards' faces or; and Gules, three mallets argent. "The first coat should be p'te p' pale b. g. the lybards' heads ar."

CREST. Out of a mural coronet argent, a leopard's face or.

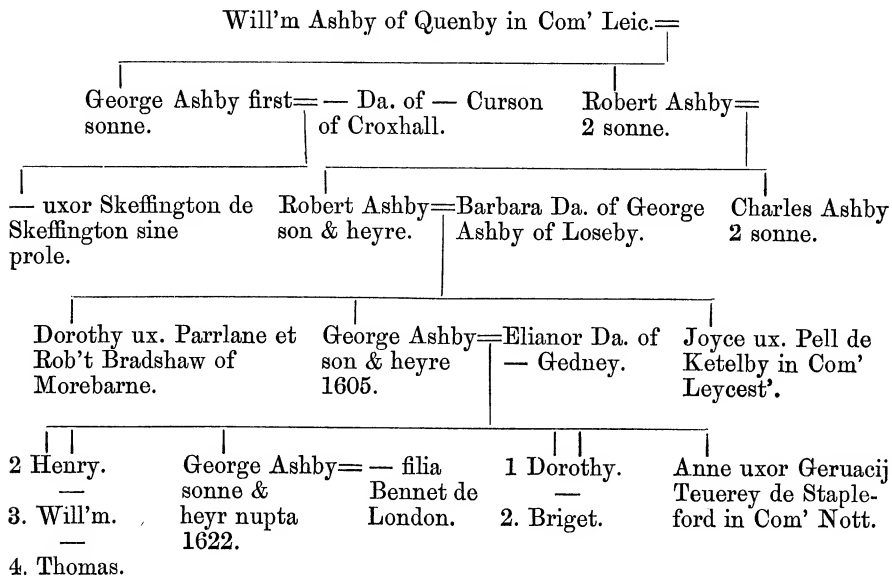

Ashby of Loseby in Leic.

ARMS. *Quarterly*:—1. *Argent, a lion rampant sable, a chief gules.* 2. *Azure, five bezants.* 3. *Azure, on two bars or six martlets gules.* 4. *Ermine, a cross engrailed sable.* 5. *Argent, a chevron gules between three door-staples sable.*

CREST. *A ram's head couped argent, attired or.*

“In the Parish Church of Loseby in Com' Leic.

1. *Argent, a lion rampant sable, a chief gules* (ASHBY), *impaling argent, a chevron gules between three door-staples sable.* 2. *A lion rampant (untinctured), a chief gules; impaling ermine a cross engrailed gules.* 3. *The same; impaling ermine on a bend azure three quatrefoils or.* 4. *Quarterly*:—*A lion rampant (untinctured), a chief gules; and azure, two bars or; impaling a chevron engrailed sable between three cross crosslets fitchée.*

Thomas Ashby of Loseby in Com' Leic. ob. 1422.=Elizab.

Thomas Ashby ob. 1433.=Katherin Da. of Rob't Brett of Addington.

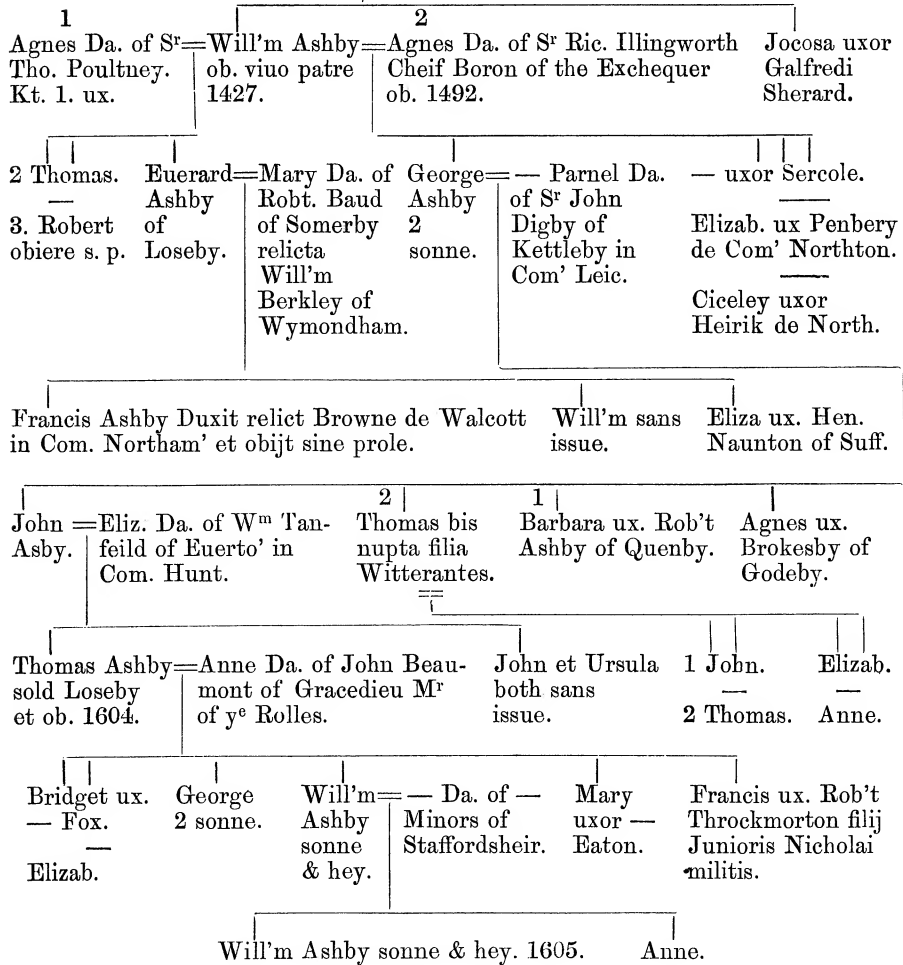

Haselrig of Noseley Com. Leyc.

ARMS. *Quarterly*:—1. *Argent a chevron sable between three hazel leaves vert.* (HESELRIG.) 2. *Vair sable and argent, a canton gules.* (STANTON.) 3. *Gules, an eagle displayed argent.* (SUTHELL.) 4. *Gules, a fess or between three saltires couped argent.* (BOIVILE.) 5. *Bendy of six gules and argent.*

CREST. *A maiden's head couped at the shoulders proper, with hair dishevelled or.*

Simon de Hasilrigg D'ns de Wotteslade et West Brunton in Com. Northumb' cui Ed. 1. dedit maneria de Yetham Corbet et Yetha' maner A° 1280.=

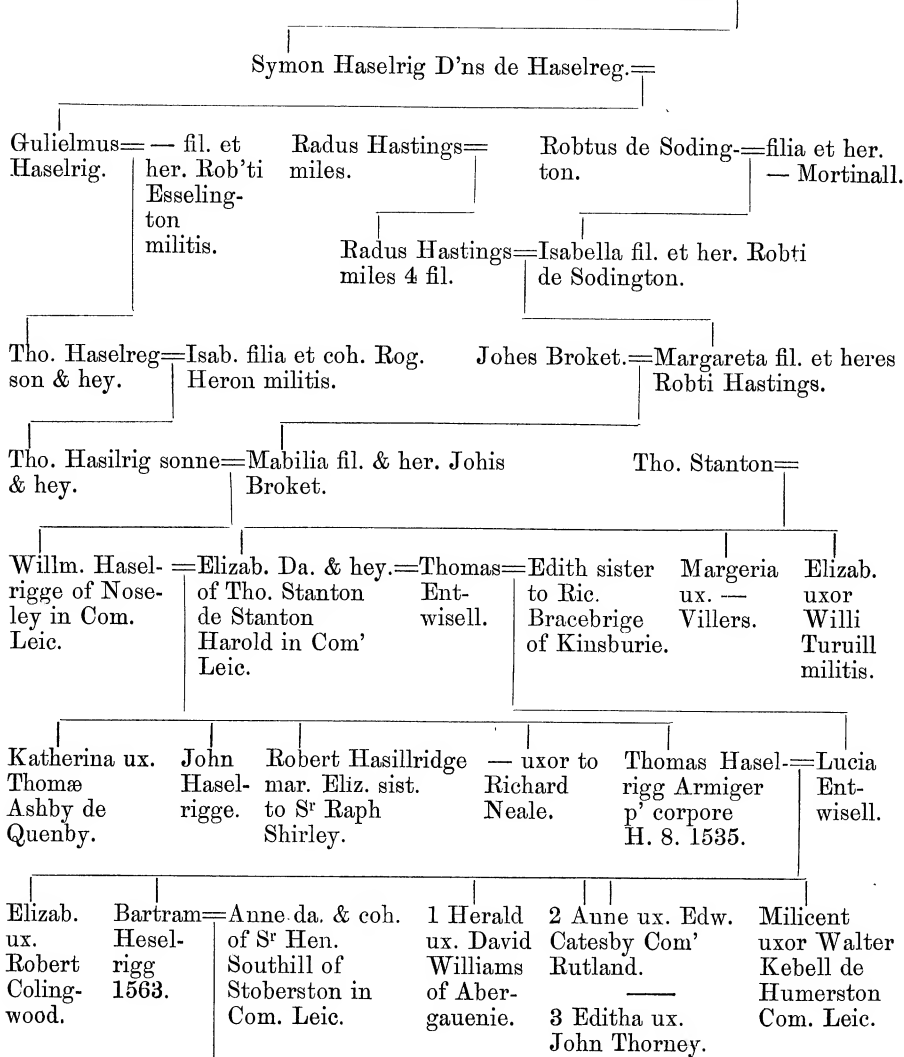

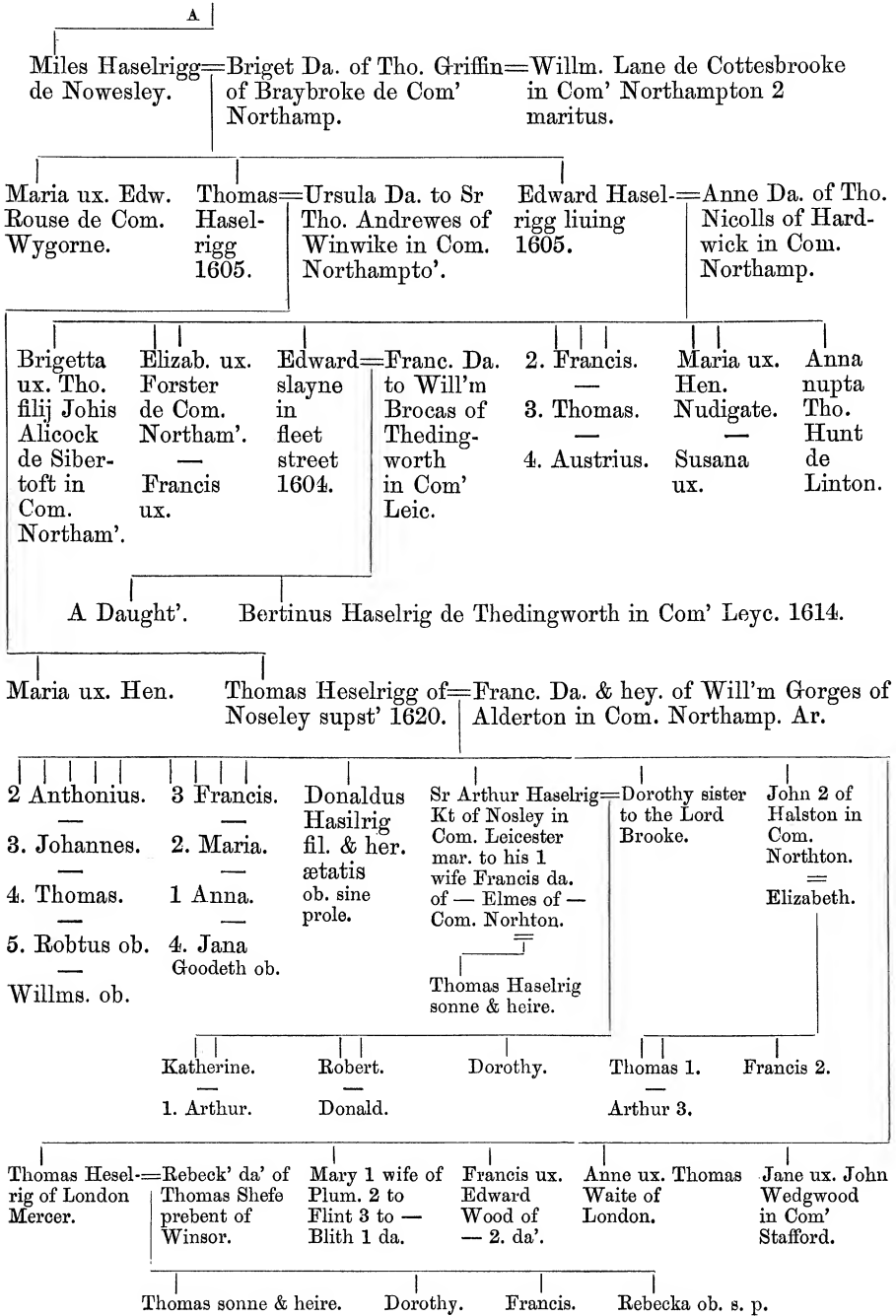

Grey of Barwell in Com. Leyc.

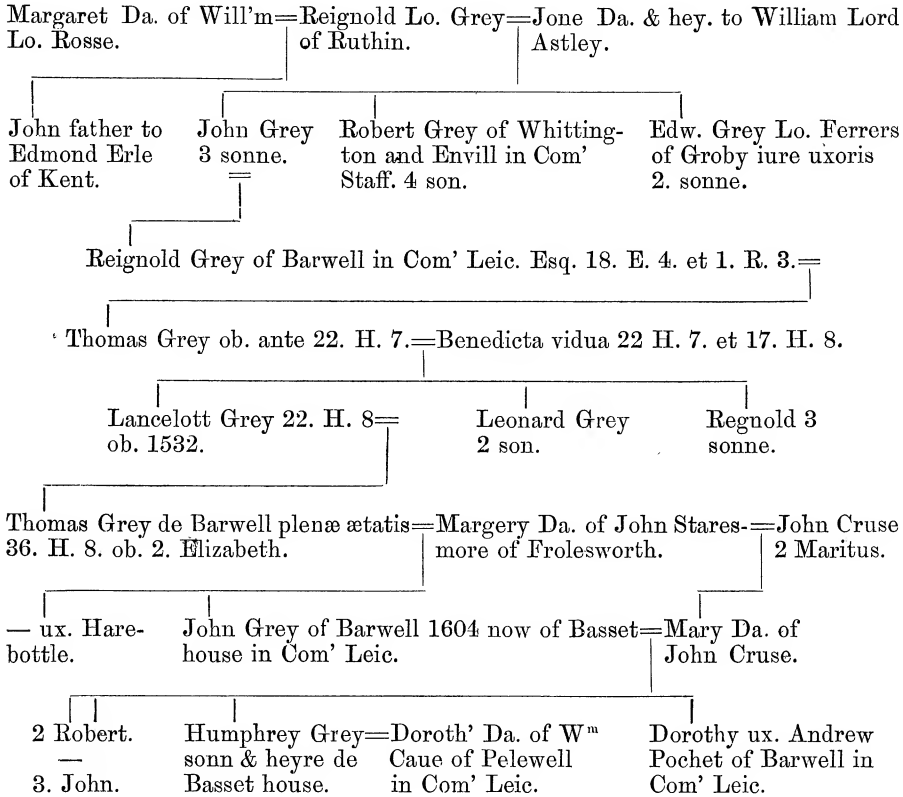

Corbet.

ARMS. *Three crows (untinctured).*

— Corbet of Ponsburie in Com' Salop. =

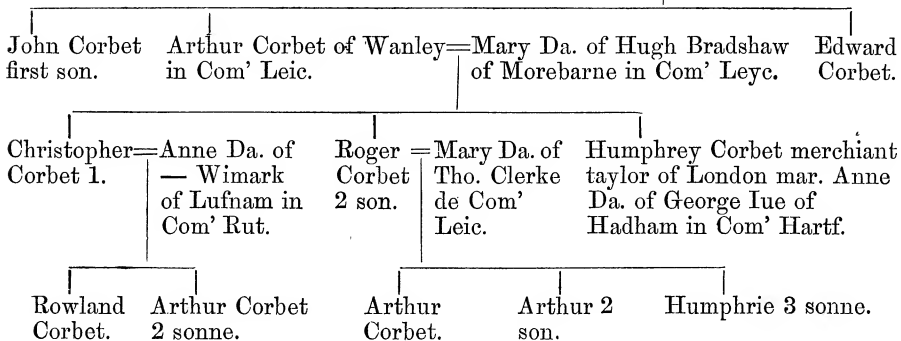

Derby.

ARMS. *Argent, a fess between three sinister wings sable.*

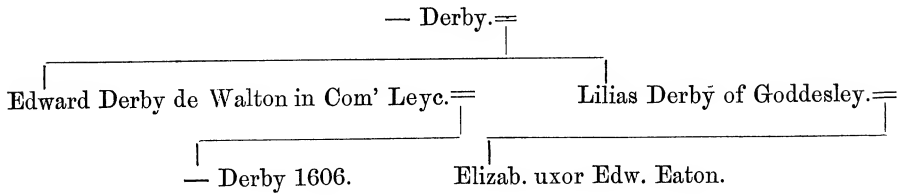

Segraue.

ARMS. *Argent, a lion rampant sable, crowned or.*

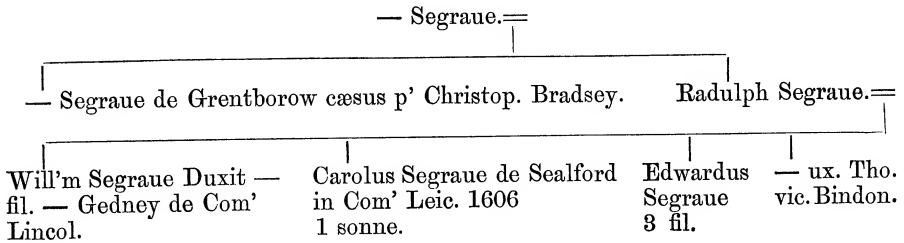

Burdet.

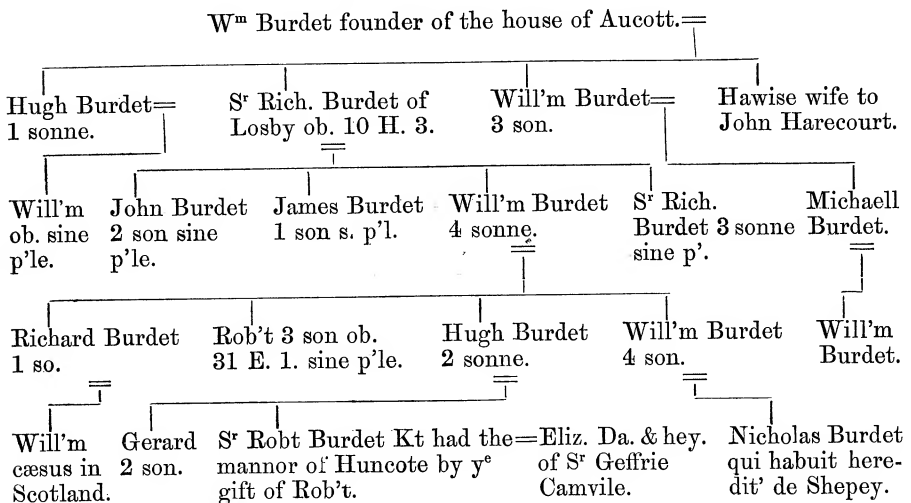

Legard.

ARMS. Quarterly :—1. *Argent, on a bend between six mullets gules a cross pattée or.*
 2. *Argent, on a bend gules three crescents of the field.* 3. *Gules, a bend or.*
 4. *Argent, three water bougets sable.*

CREST: *A greyhound statant collared or, studded gules.*

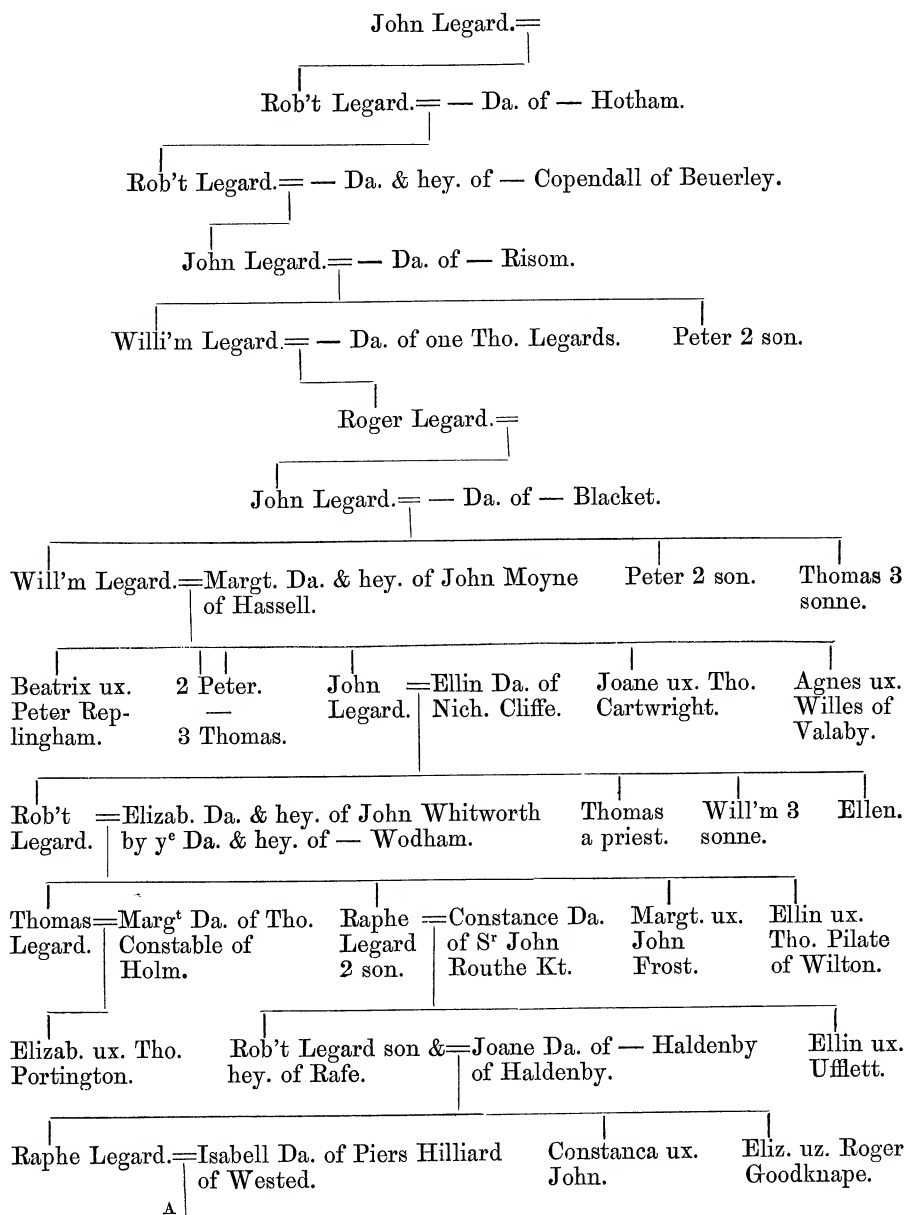

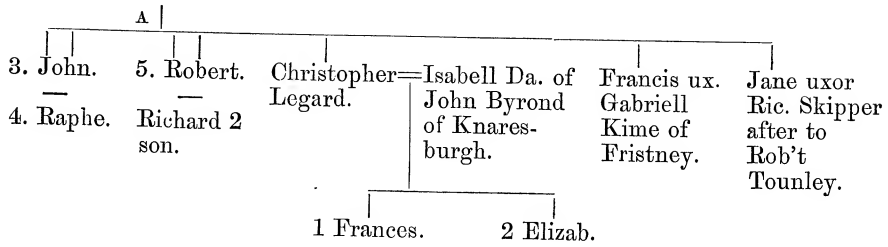

Cheselton.

ARMS. *A chevron between three crosses moline (untinctured).*

CREST. *A dog couchant, with collar and line reflexed, nowed at the end (untinctured).*

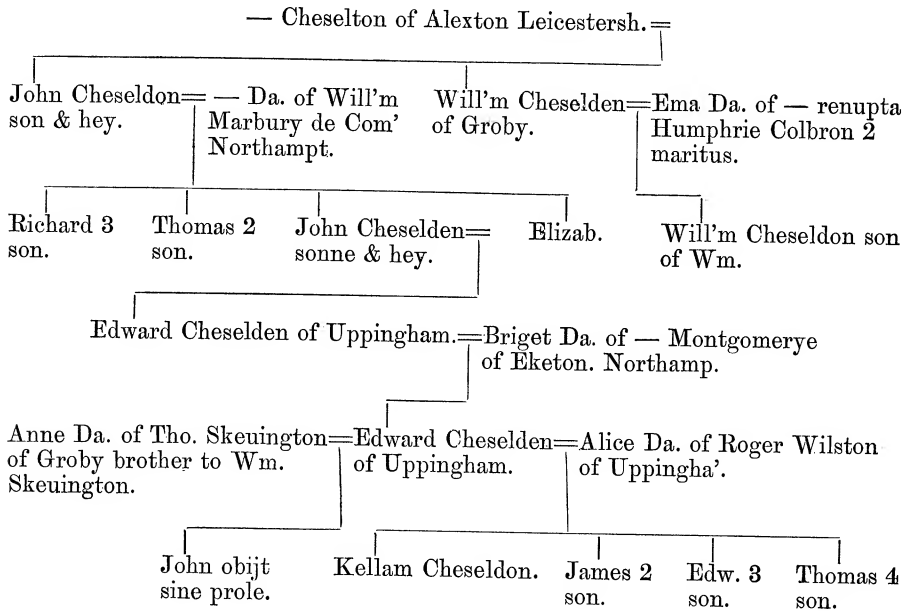

Neuill of Holte, Leic.

- ARMS. *Quarterly* :—1. *Sable, a cross gules between four peacocks argent.* (SMITH.)
 2. *Quarterly argent and sable, in the first quarter a fleur-de-lis of the last, and in the fourth an ermine spot.* (LANEHAM.) 3. *Argent, on a chevron azure three escallops of the field, on a chief of the second a lion passant of the first.* (HINDE.)
 4. *Gules, a saltire ermine.* (RABY.) 5. *Or, fretty gules on a canton per pale (untinctured) a lymphad.* (NEUILL.) 6. *Gules, a lion rampant or.* (BULMER.)
 7. *Bendy of six gules and vert, over all a chevron ermine.* (BLANCHMINSTER.)
 8. *Or, two bars nebulée sable, a canton ermine.* (ROLLESTON.) 9. *Azure, a fleur-de-lis or.* (PALMER.) 10. *Bendy of six (untinctured), over all a chevron ermine.* (INGLEBERD.) 11. *Bendy of six or and azure, a canton ermine.* (BISHOPSTON.) 12. *Or, a chevron gules, a chief indented vert.* (FENCOTES.)
 13. *Lozengy argent and sable.* (CROFTES.)

Robt. Lo. of Raby.=Isabell Da. & hey. of Galfred Neuill.

Galfred surnamed Neuill Lo^r of Raby.=Margt. fil. Jo. Longuillers.

Robt. Lo.=Isabella fil. Rogeri Bartra' Jolanus Neuill Senior=Maud Da. & coh.
 Neuill. D'ni de Mitford. Lo. of Holt & Pichall. to La. Eua Gray.

Robt. Lo.=Mary D'na de Midleham Jolanus Neuill=Amphelicia Lady of
 Neuill. fil. & her. iunior. Rolleston.

Ranulphus=Eufemia fil. et S^r Andrew Neuill Lo.=Cicilia Da. & coh. to Raphe
 Lo. her. Johis D'ni of Holt, Pichall & Blanchminster Lo. of Silly
 Neuill. de Clauering. Rolleston. & S^r Mary Wike.

Radulphus Neuill D'ns=Alicia fil. Hugo S^r Will'm Neuill=— Da. & coh. to
 de Raby et Mid. D'ni de Audley. of Holt &c. S^r Tho. Fencotts.

Johes Neuill=Matilda fil. S^r Raphe Neuill= S^r Rob't Neuill=— Da. of S^r
 D'ns de Dni Hen. of Condall. of Holt in Raphe Lang-
 Raby. de Percy. Com' Leic. ford Kt.

Raphe Neuill S^r Alexander= S^r Thos. Neuill=Elizab. Da. of Tho. Palm'
 first Erle of Neuill of after to of Rolleston in W^m Babing- ob. 3 Sept.
 Westmerland. Thornton- brige. Com' Nott. ton Justice. 15. E. 4.

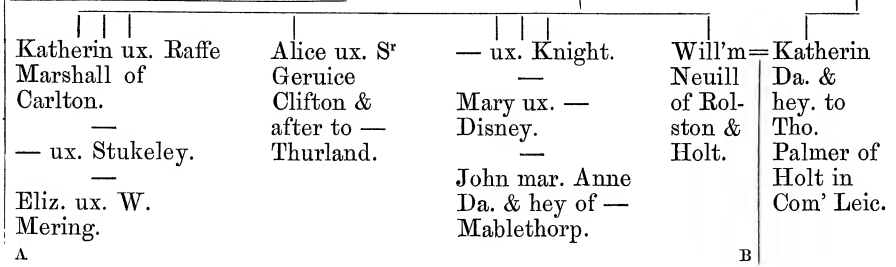

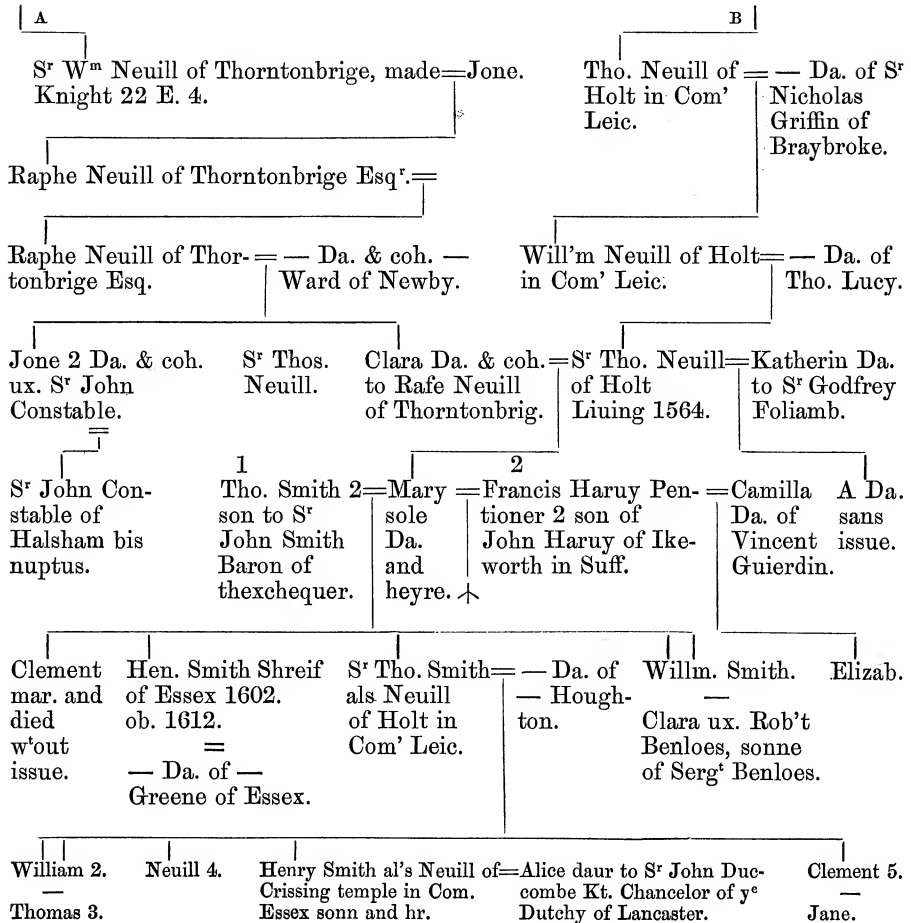

Burdet Leic.

ARMS. Quarterly:—1. Azure, on two bars or six martlets gules. 2. Azure, three lions passant in pale argent. 3. Gules, a lion rampant ermene. 4. Gules, a fess or between six martlets argent.
 CREST. A lion's head erased sable.

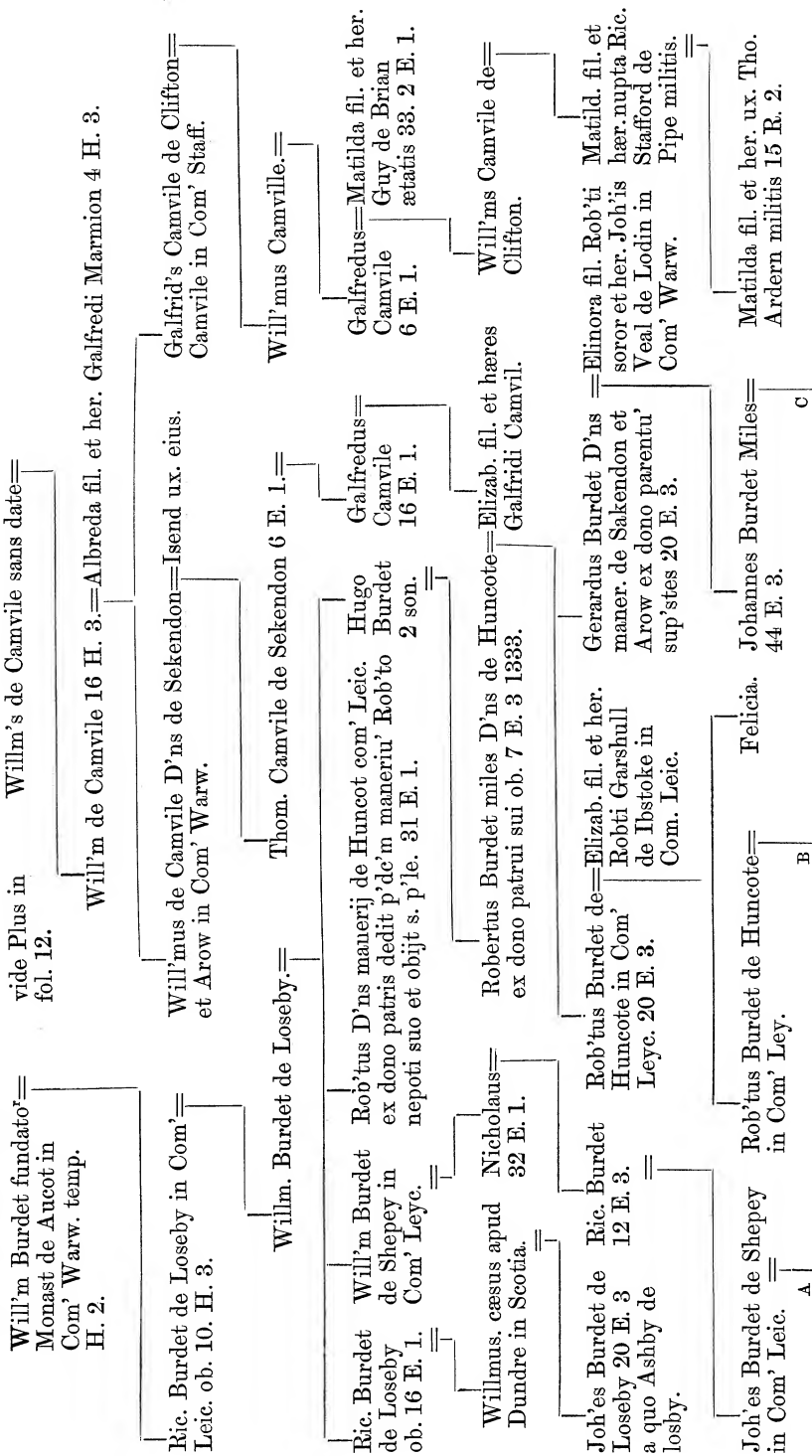

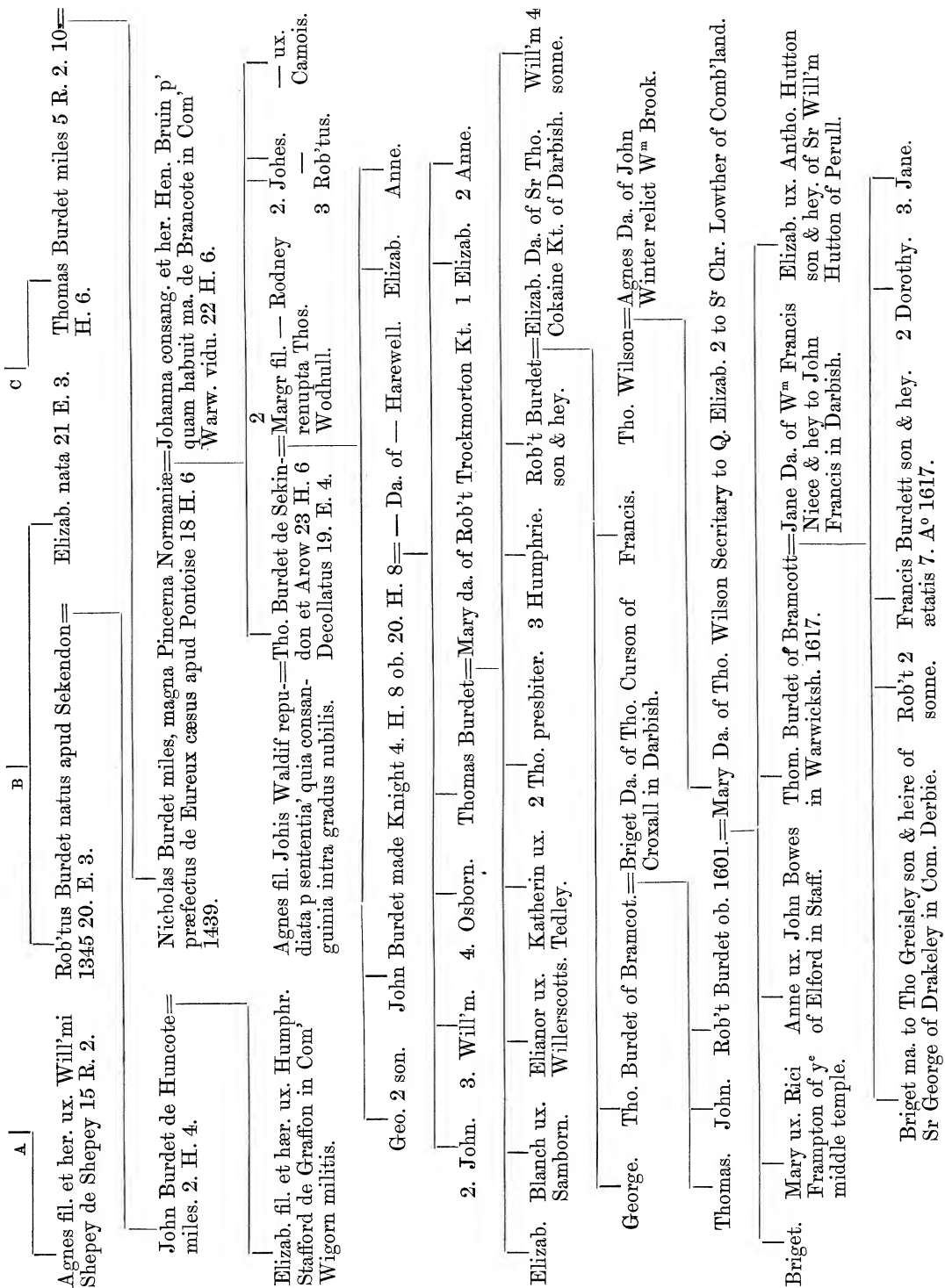

Shirley.

Sewall son of Fulcher originall auncest^r of this family of Shirley. =

Henry son of Sewall held 5 knights fees in Darbish. =
of Rob't Ferrers Lord of Titburye.

Fulcher 2 son
of Sewall.

Sewall son of Henry held 9 knights fees of Wm. Erle Ferrers =
in the dayes of K. H. 2.

Henry son of Sewall surnamed of Etingdon wher he first =
founded a Chauntry in K. Johns tyme.

Sewall son of Henry of Etingdo' confirmed the Donation =
of his father made to the Chauntry of Etingdon' 27 H. 3.

Henry 2 sonne
of Henry.

Jeames sonne of Sewall surnamed Shirley, = Agnes Da. of Symon of Walton
liued A^o. 15. E. 1. after Bishop of Norwich.

S^r Raphe Shirley Kt. Lo. of the = Margt. Da. & coh. of Will'm Waldeshef
manner of Shirley. of Boyleston.

S^r Tho. Shirley Kt. son of = Isabell sister to Rafe Lo. Basset
Sir Raphe. of Drayton.

S^r Hugh Shirley of Shirley Kt. he was M^r of the = Beatrix sister & sole hey. to
Falcons to K. H. 4 & was slayne in his parte Sir John Brewes Kt.
at y^e battell of Shrewsberie A^o 4 H. 4.

Isabella ux. Sr
John Cockaine
of Ashbourn
in com. Darby.

2. Elizab.
—
3. Nicholas.

Alice = Sr Raphe Shirley kt. high =
uxor Shreife of the County of
2. Nott' & Derby A^o 9
H. 5 ob. ultra mare.

Johanna first
wife Da. & sole
hey. of Tho.
Basset of
Brailesford.

Beatrix ux.
John Brome
of Bedesley
Clinton in
Com. Warw.

Margt. first wife sist^r =
& hey. to Tho.
Staunton of Stanton
Harald in Lesto'sh.

Raphe Shirley Esq. whose =
3 wife was Lucy Da.
of John Ashton & wydow
of Sir Ric. Birom.

Elizab. 2 wife
Da. of Sir Tho.
Blount and
sister to Walter
Lord Montioy.

A

B

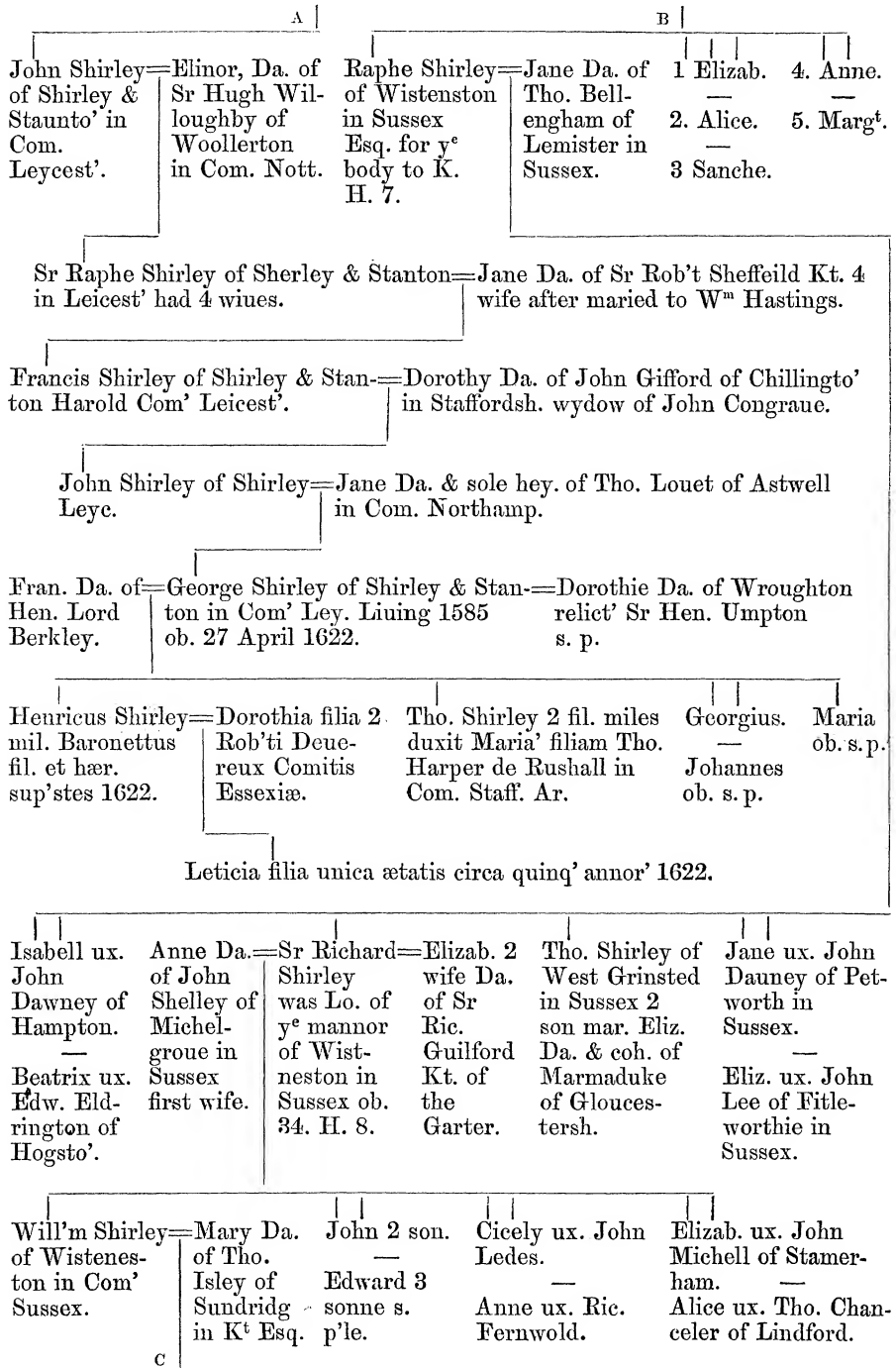

c |

Sr Thomas of Wiston in Sussex & Thresuro^r = Anne Da. of Sr Tho. Kempe by
of the Warres in the lowe Countries was Catherine Cheny his first wife hey.
Liuing A^o 1609. of Frowick.

Sr Tho. Shirley 1 sonne Liuinge 1618.	Sr Anthoine 2 sonne now Lyuing in Italy but hath traualed most parts of Asia & Europe 1619.	Sr Rob't Shirley now Lyuing in Persia & hath married the Sophi Neece he cam Emb. fro' y ^e great Sophi into England Anno 1608 & noble entertayned.
---	--	--

1 Mary. 2. Elizab. 3. Margt. 4. Jane. 5. Anne. 6. Cicely.

Lawrence.

ARMS. Three lozenges, each charged with a saltire (uninctured).

John Lawrence of = Katherin Da. & hey. of — Dalton of the
Lancash. Bishoprick of Durha'.

John Lawrence al's Dalton. = Elizab. Da. of Tho. Killingham.

Constance ux. Will'm Lampton of Bolses. — Will'm 2 son ob. sine p'le.	Da. of Strang- ways 1 wife.	= Rafe Dalton = of Westoke- land son & hey.	= Jane Da. of John Red- man of Twiselton.	Anne ux. Tho. Wrenne of Gil- lirow. — Jane ux. Hen. Todd.
Elizab. Da. & hey. mar. to John Hutton of Hunwyke.		6 sonnes all ob. sine p'le.		

Faunt.

ARMS. *Quarterly*:—1. *Argent, a lion rampant between five cross crosslets fitchée gules.* 2. *Argent, two bars, and in chief three mullets sable. Or, a saltire sable, in chief a mullet for difference.*

CREST. *A naked boy crined or, in the dexter hand a toy (paper windmill?) of the last.*

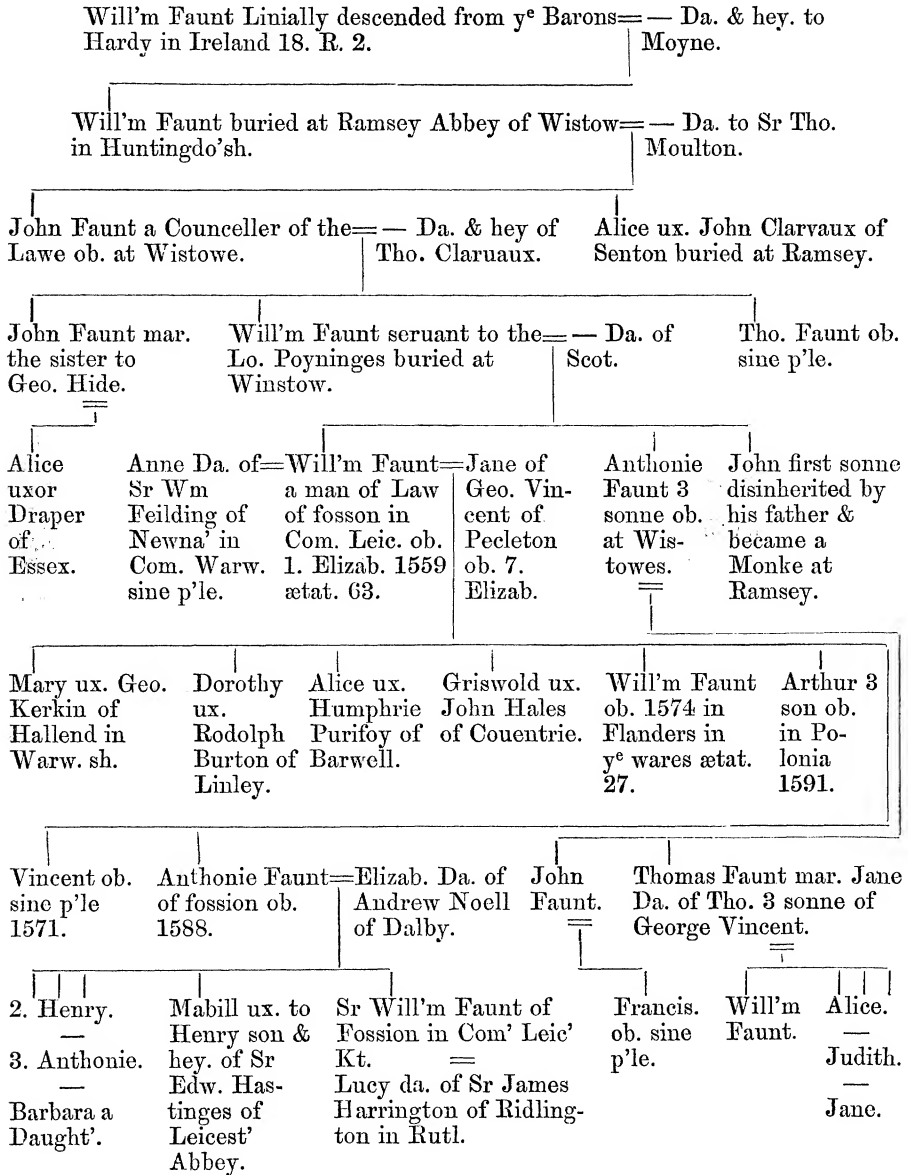

Villers.

ARMS. Quarterly:—1. Argent, on a cross gules five escallops or. 2. Sable, a fess between three cinquefoils argent. 3. Gules, a chevron between three cross crosslets fichée argent. 4. Per pale gules and sable, a lion rampant argent. 5. Azure, a bend (uninctured) between six stars argent. 6. Argent, a cross vert, in the first and fourth quarters an annulet of the last.
 CREST. A lion rampant crowned (uninctured).

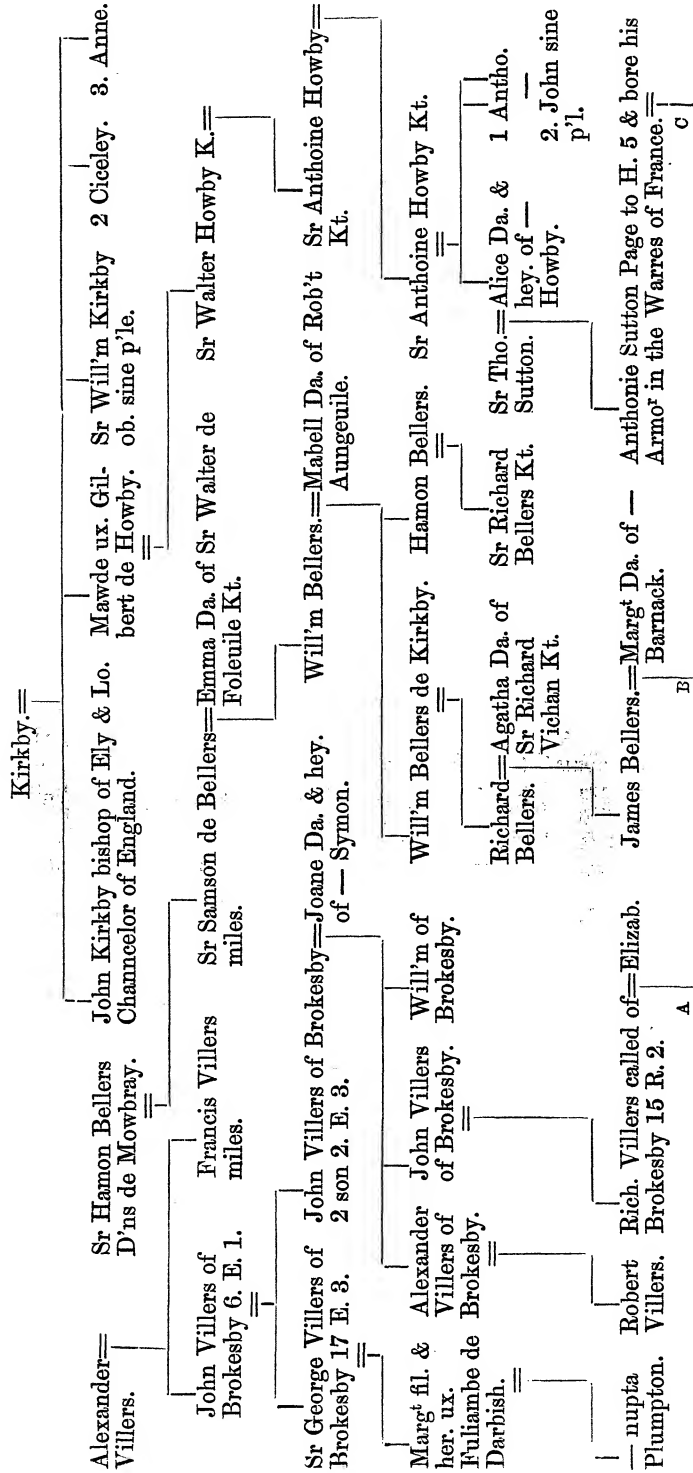

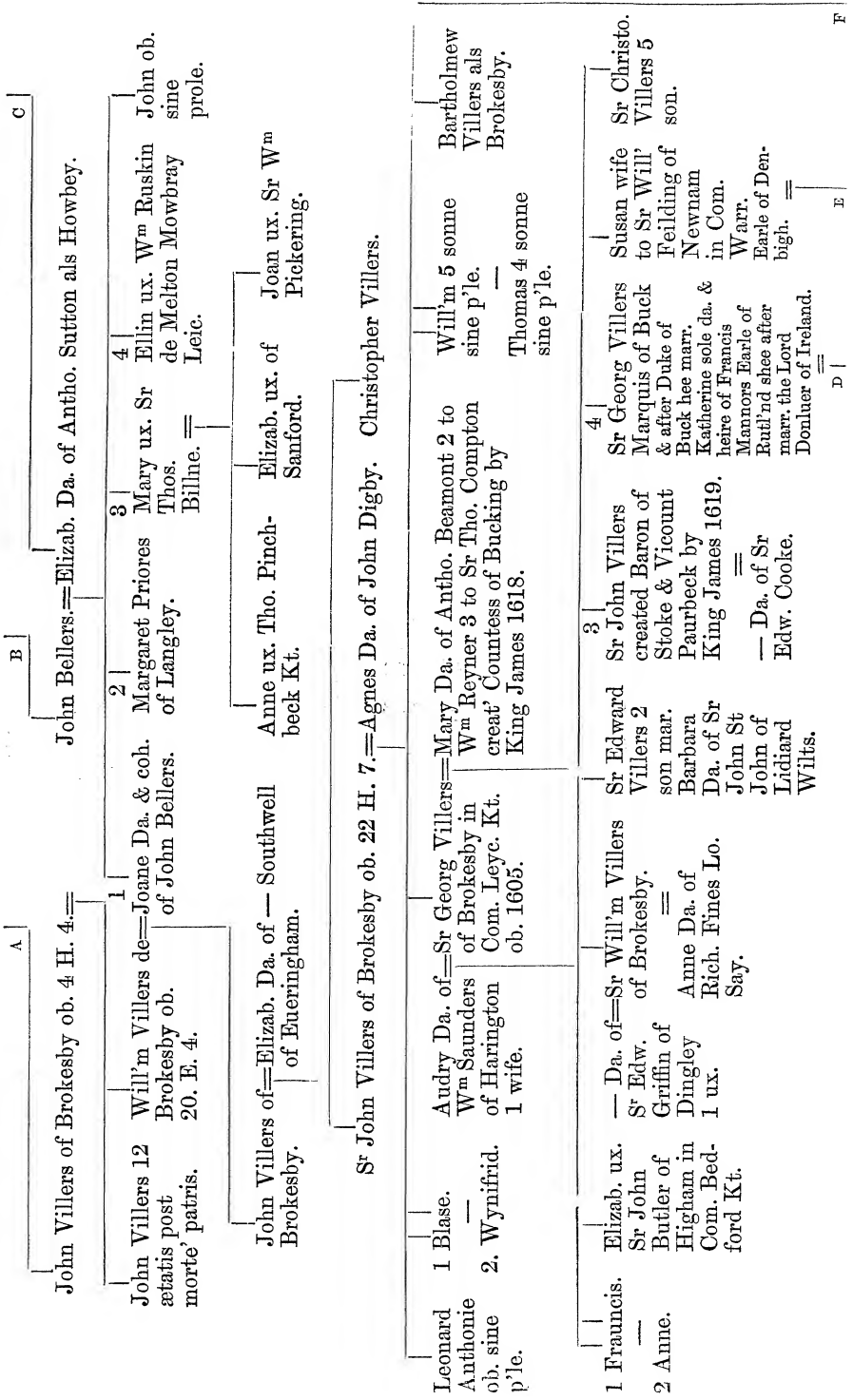

F

E

D

C

B

A

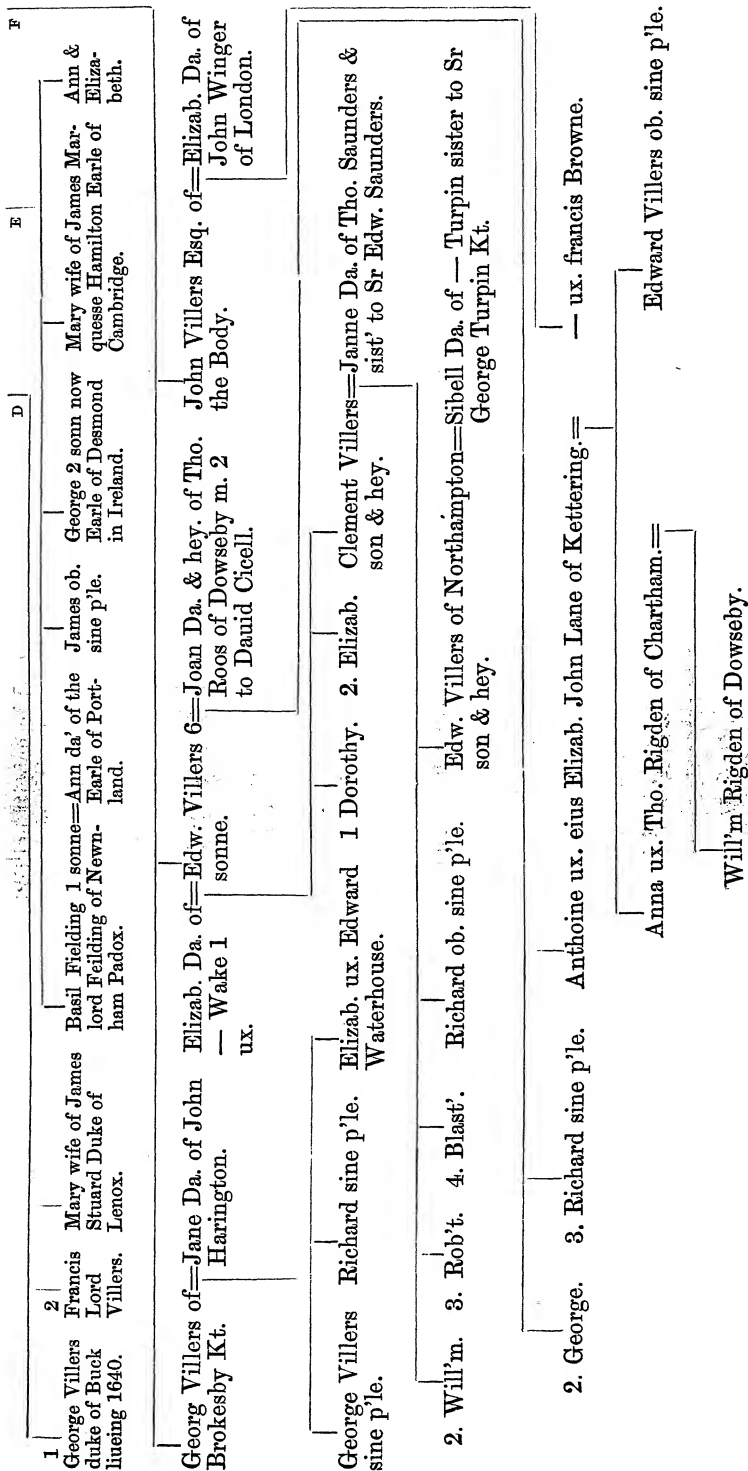

Purifoy.

ARMS. *Quarterly*:—1. *Blank*. 2. *Argent, on a fess sable three escallops of the field*. 3. *Azure, three stirrups or*. 4. *Gules, a chevron ermine between three leopards' faces or*. 5. *Gules, three piles meeting in base or, on a canton sable a mullet argent*. 6. *Blank*. 7. *As second*. 8. *As third*. 9. *As fourth*. 10. *Quarterly, gules and or*. 11. *Or, on a fess gules three water bougets of the field*. 12. *Azure, a cross engrailed or*. 13. *Gules, a fess ermine between two chevrons or*. 14. *Paly of six or and azure*. 15. *Blank*.

CREST. *A dexter gauntlet erect, grasping a broken tilting spear in sinister bend (uninctured)*.

Will'm Purefoy de Minsterton in Com. Leycest. 20 H. 3 1275.==

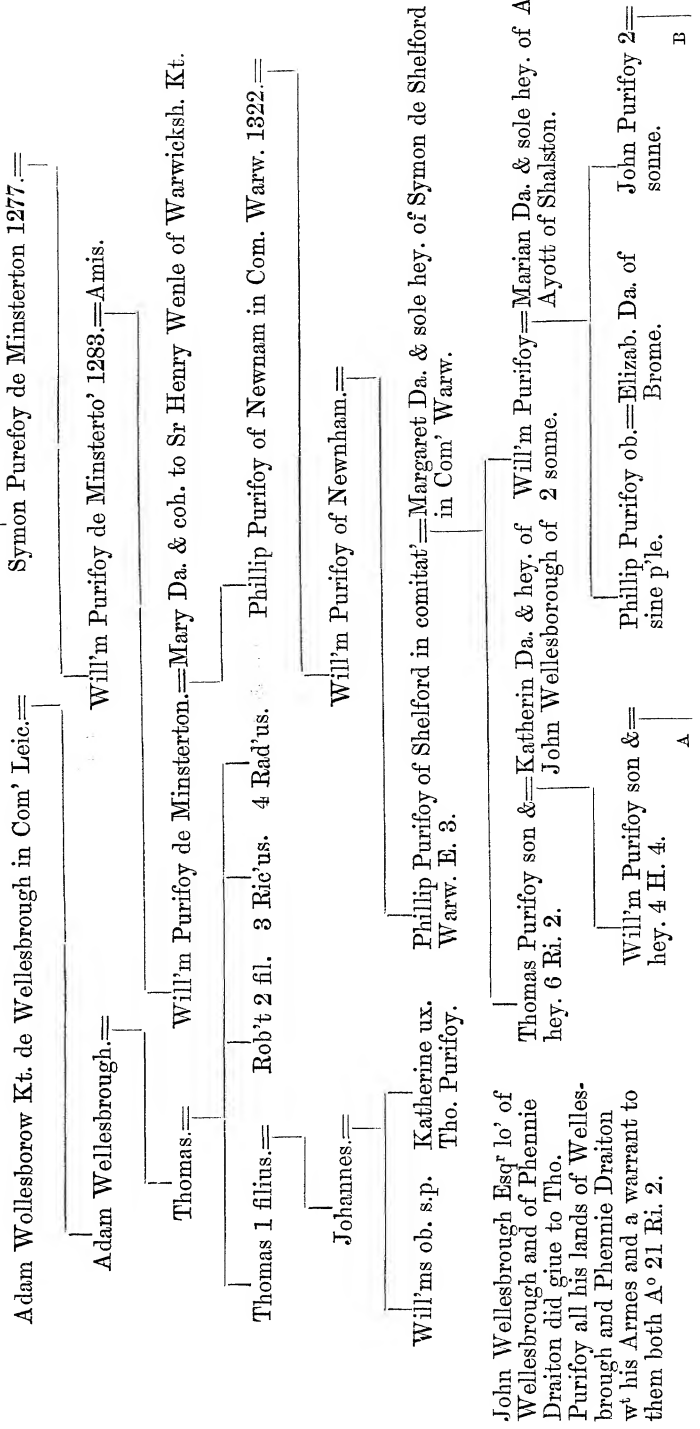

* This Will'm was slaine by Sr Hen. Willoughby at Bassets crose besides Tamworth in Com' War. the one being of the partie of K. H. 6 the other of Edw. 4.

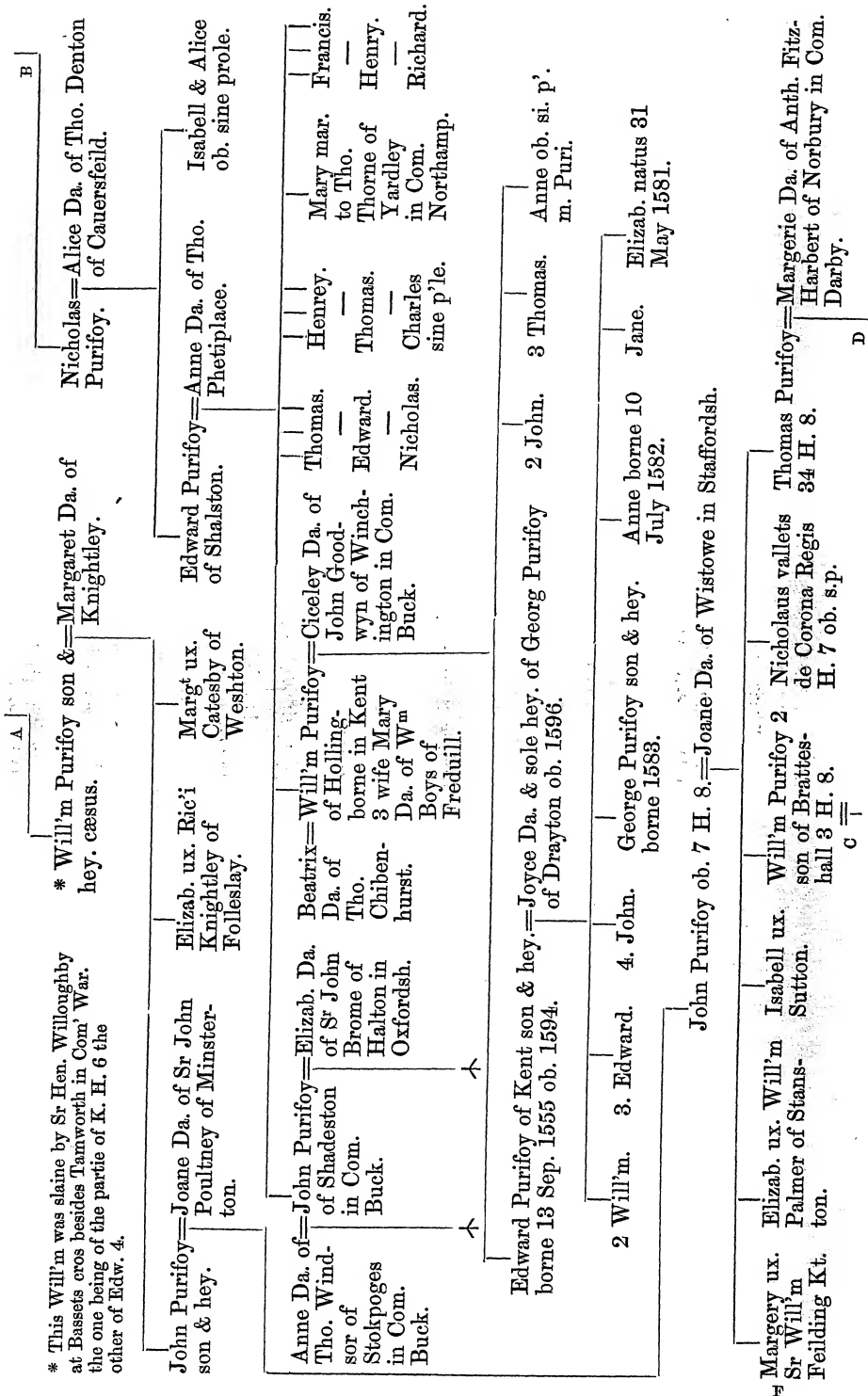

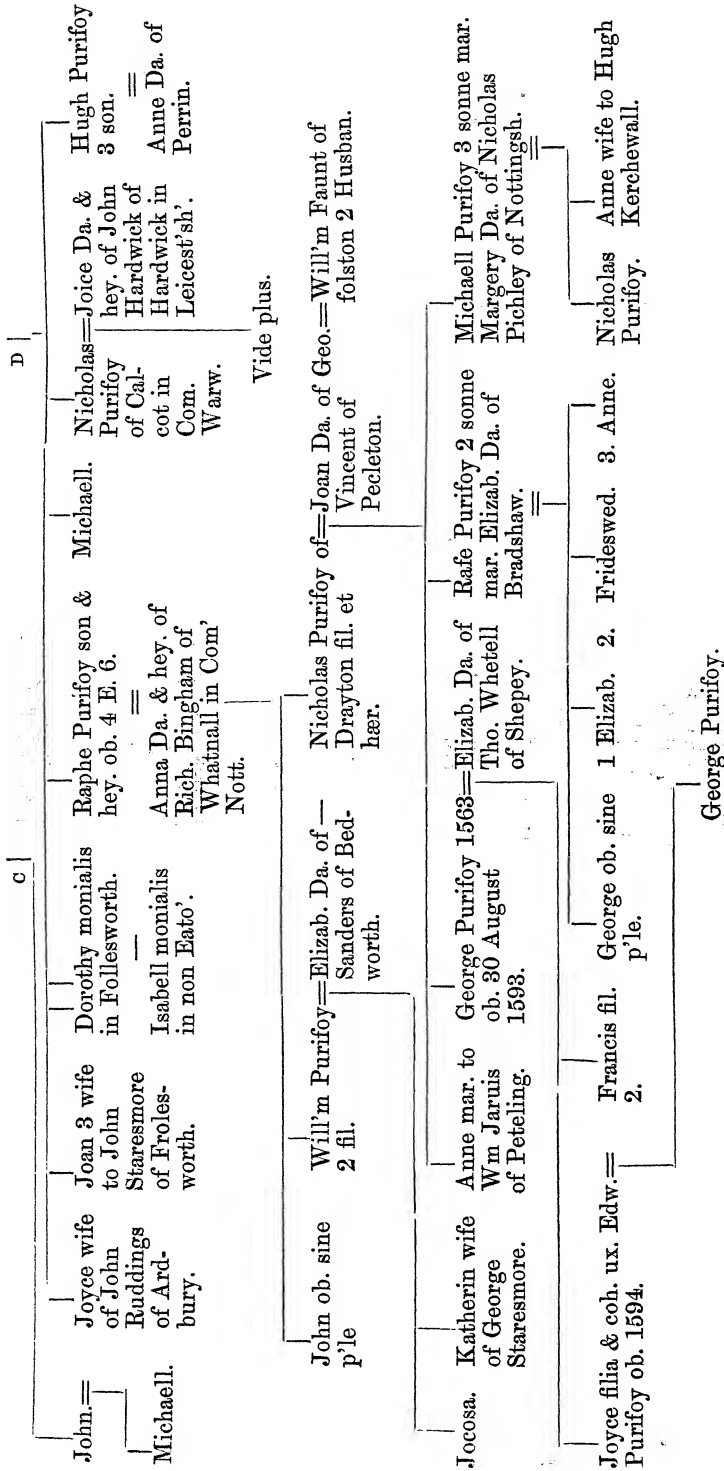

Purifoy.

Will'm Purifoy. = Marian.

John Purifoy 2 Phillip Purifoy buried in = Isabell Da. & hey. of John Brome = John Denton 2 husband.
sonne. Badesley ob. sine p'le. of Badesley in Warw.

Clemence Da. of Lidiard = Nicholas Purifoy of Shalston 3^d = Alice Da. of Thomas Denton. Anna wife to Sr Edward Greuill. =
& Wydow of Eyre married Katherin Da. of Ric. John Denton
2 wife. Broysesfeild. 1 wife.

Sr John Greuill. Sr Foulk Greuill.

Simond Purefoy = Barbara Da. of Will'm Dixwell of Churchouer. Susan mar. to Edw. Jenney of Suff.

Martyn Purefoy = Anne Da. of Rooke de Kent. Elizab. wife to Will'm Ackworth of Hernhill in Kent.

2 Thomas. 3. Will'm. 4. Martin. 5. Simon. 1 Anne. 2. Elizab. 3. Jane. James Purifoy son & 4 Joyce. 5. Ciceley.
hey. A^o 1601.

Isabell wife to Tho. Martyn Purifoy. = Elizab. Da. of Reinold Francis rector Ecel'ia = Anne Da. of Ric. Pheti-
Goodwin Bishop of Willm's brother to the de Ruckings in place borne in p'ua
Bathe & Welles. Lo. Willm's of Tame. Kent. Sheiford 16 July 1496
et ob. 3 Aug. 1568.
A B

A	B
Richard ob. at Breast in Britanie. 1 Elizab. 2. Lucas. Anne. Diolata.	
Mary wife to Tho. Susan a Thorne of Yardley at Syon. man ob. sine p'le	Francis Purifoy = Anne Da. of Anthonie Furtho of Furtho in Com' Northa'. 4 some ob. 1564.
Tho. Purifoy mar. the Rich. Purifoy = Da. of Pell wydow of Nich. Foxston.	
George ob. sine p'le.	Elizabeth.
Anne Da. of Tho. = John Purifoy 1 = Da. of John Windsor 2 son ob. sine prole.	Beatrice Da. & hey. of = Will'm Purifoy 2 = Ciceley Da. of John Goodwin of Winchington in Com' Buck. Tho. Cheselhurst wydow of Strelley 1 ux. sine p'le.
Edw. Purifoy borne = Joice Da. & sole hey. of 13. Sep. 1555. et ob. 1594.	John Purifoy 2 son Canonicus Thomas Purifoy 3 = Blendina Da. of Tho. Goodwin Bishop of Bath & Wells. Geo. Purifoy of Drayton ob. 1596. sine p'le 1601.
Janill. Elizab. nata 31 May.	Anne Borne 10 2 Will'm. 3. Edward. 4. John. Georg Purifoy son & hey. Borne 1588.

Purifoy.

Michaell Purifoy of Caldecot 2. son of Tho. Purifoy of Drayton = Joice Da. & Coh. of John Hardwick of Lindley in Com' Leic.

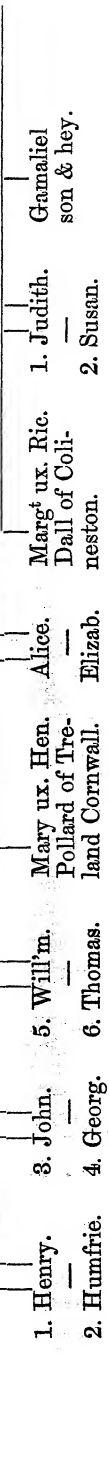
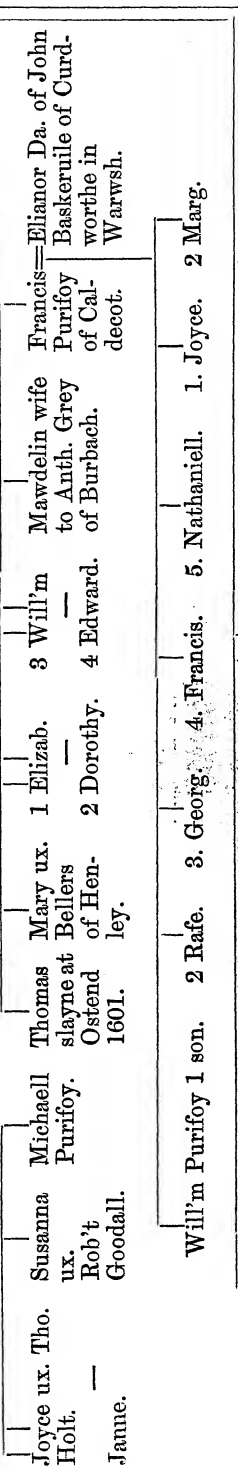
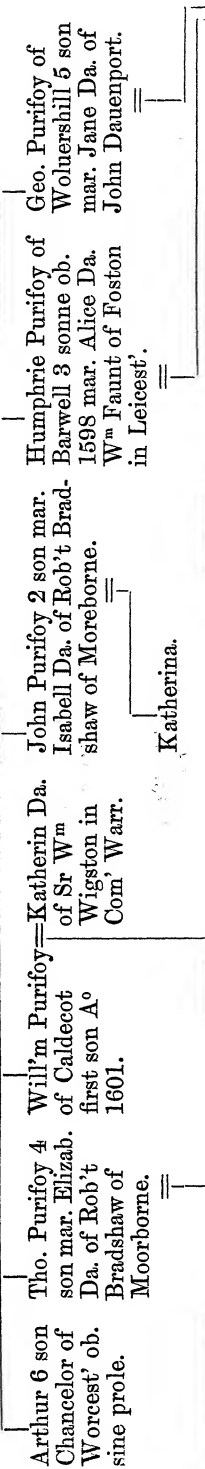
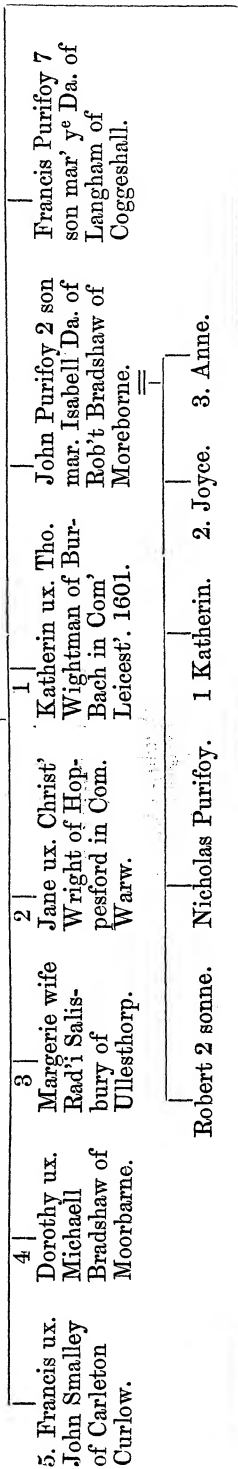

Woodford et Turuill.

Sr Hugh.

Radulphus Woodford. =

Mathew Wood- ford mar. Lucy Da. of Will'm Brokesby.	John 3 filius Duxit Mili. Fil. Thomæ Markham.	Will'm = Anna filia Simonis Wood- = Norwich de ford. = Brampton in Com' Northamp.	Rob't 4 fil. — Thomas ob. sine p'. — Johanna.
--	--	--	---

Johannes Turuill fil. et her. Turuill de Newhall ob. ætat. 22. = Margareta fil. & her. postea uxor Will'mi Turuill frater Johannis.

Hubert.

Sr Hugh Hubert Kt. = Da. of Sr Thomas Corbet Kt.

Sr Hugh Hubert of Stapleford in Com. Leic. Kt.	= Anne Da. of Thomas Brestofte.	Walter Bar- nack.	= Da. of Woodford.
---	------------------------------------	----------------------	-----------------------

Sr John Hubert Kt. = Mary Da. of Tho. Ailesbury.	Walter Barnack. = Elianor Da. & hey. of Borough.
---	---

Sr Henry Hubert Kt. = Jone Da. & hey. of Walter Barnack.

Robt. Sherard = Anne Da. & coh. of Stapleford. to Sr Hen. Hubert Kt.	Mawde ux. Sr Hughe Calueley Kt.	Mary uxor Sr Norman Swinford Kt.
--	---------------------------------------	-------------------------------------

Palmer et Harecourt.

ARMS. *Azure, three fleurs-de-lis argent within a bordure engrailed or.*

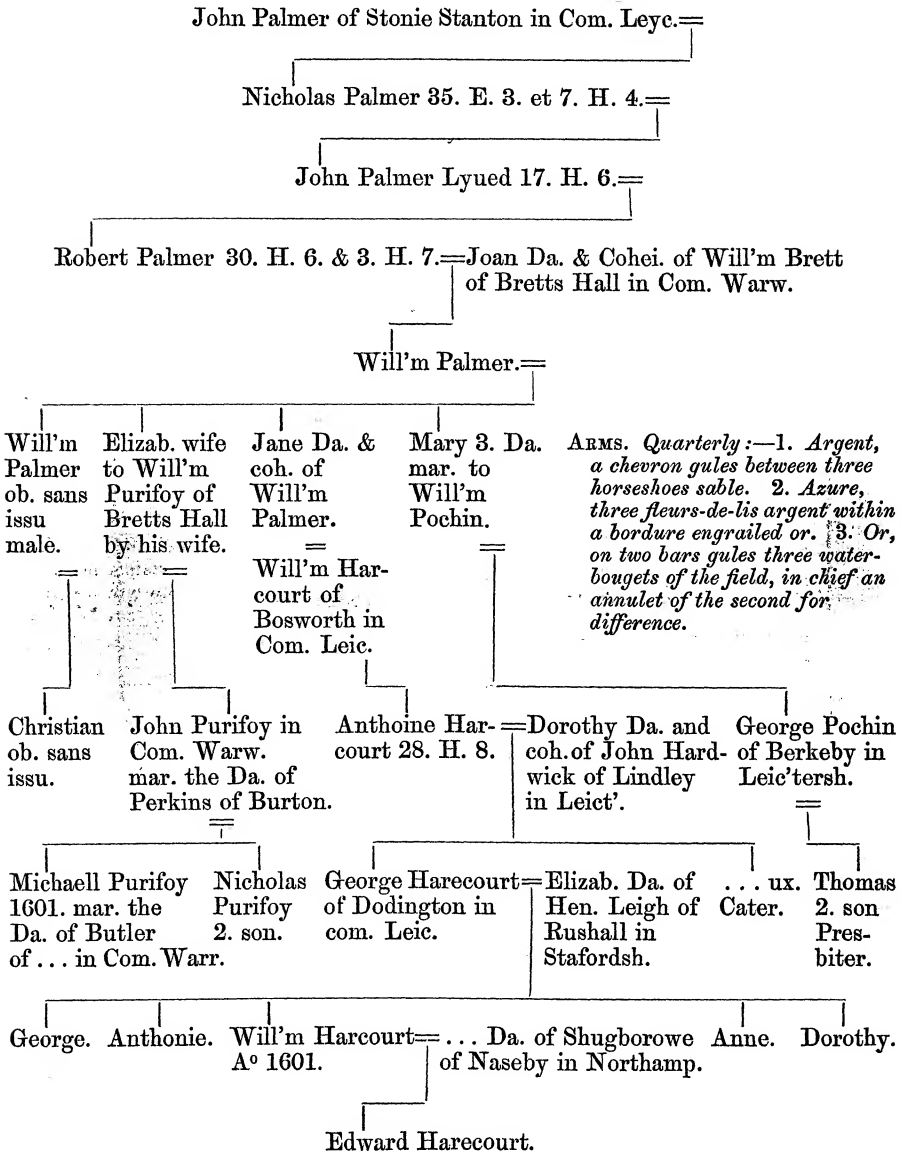

Digby.

ARMS. Quarterly:—1. Azure, a fleur-de-lis argent, in dexter chief a crescent for difference. 2. Gules, a fess ermine. 3. Argent, on a bend gules three martlets or. 4. Argent, on a fess sable three mullets of the field between as many martlets of the second. 5. Ermine, on a bend (uninctured) three chevrons (uninctured). 6. As first.
 CREST. An ostrich argent, holding in its beak a horse-shoe (uninctured).

Rob'tt Digby = Jane Da. of Sr James Bellers renupia Tho. Seyton.

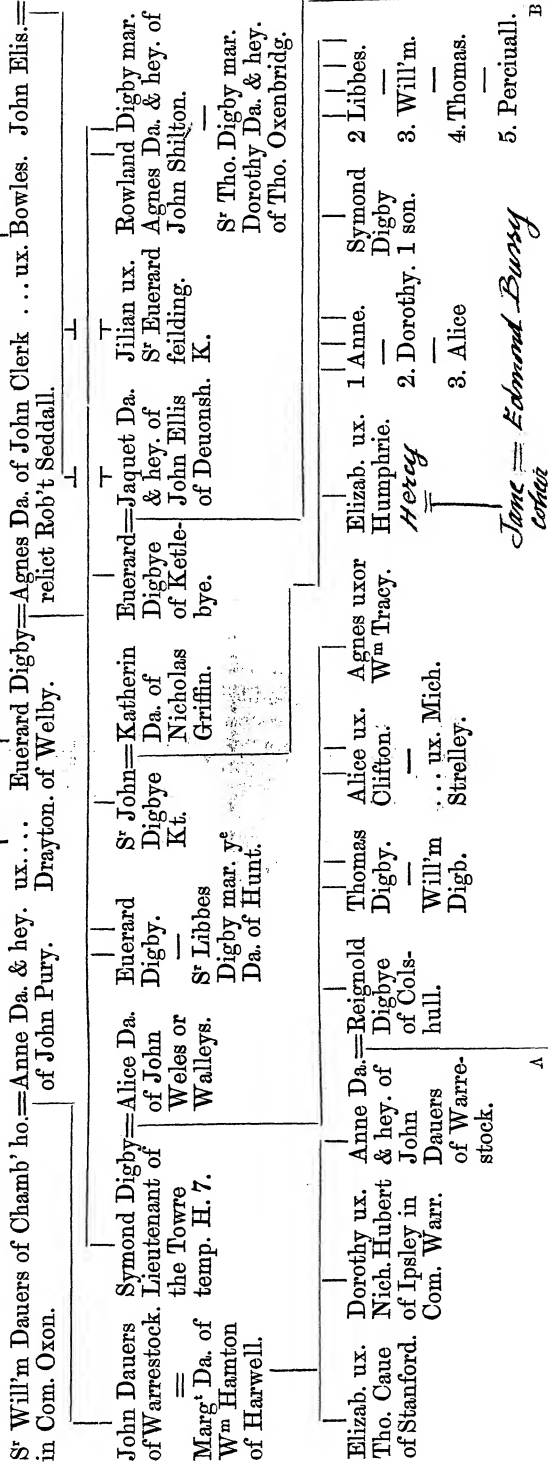

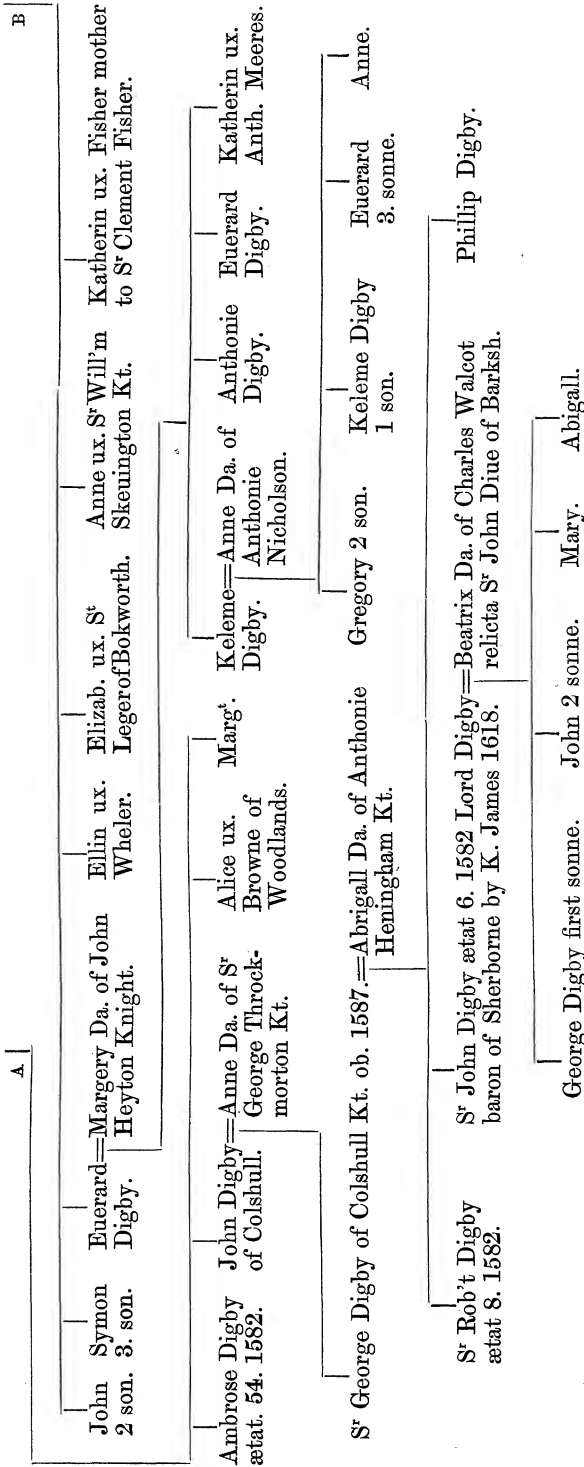

(Winter.)

ARMS. *Quarterly* :—*Sable, on a chevron argent between three tuns (untinctured) a chessrook azure; and gules, a saltire engrailed argent between four mullets or.*

ANOTHER COAT. *Chequy or and sable, a fess azure. This erased, and at the top is written "Nihil."*

CREST. *A hawk close argent, holding in its dexter claw a fish erect or.*

Henry Winter of Worthington in Com' Leic. =

Rob't Winter de Worthington. = filia English.

George Winter of Northington = Anne Da. & coh. of John Hardwick of Lindesley in Com. Leicest. in Com. Leic. by the Da. of Loughton.

Anne wife to John Bowles of Lincolnsh.

Elizabeth wife to John Crewker postea to Tho. Bradbrig.

Edward Winter of Northington.

= Katherine sist' to Sr Wm. Grisley Kt.

Joyce wife to Willington of Hurley.

Georg Winter son & hey.

Edward Baskeruile of Careyworthy.

= Mary 1 Da. & coh. of Edw. Winter.

Anna 2 Da. wife to Winter of Worcestersh.

Ciceley uxor Rolandi Stockey de Leycest.

Ursela.

Edward Baskeruile first son.

John 2 son.

Margaret.

(Repington.)

ARMS. *Quarterly* :—1. *Gules, a fess dancetty ermine between six billets or.* 2. *Gules, a saltire or.* 3. *Gules, a crescent or.*

Will'm Repington of Armington. =

Mary wife to Swinfen of Swinfen.

Anne wife to Tho. Cockin of Holland.

Francis Repington of Armington.

= Maudes Da. of Ric. Cotton of Ridware in Com. Staff.

Katherin ux. of Rob't Burton of Lindley.

Edith a nun at Pelesworth.

Will'm — Richard.

Thomas Repington 1601.

= Francis Da. of W^m Stanford Justice of the Common pleas.

Margaret wife to Kendall of Smitheses in Darbsh.

= Sr Clem^t Fisher of Packington in Com' Warw. 2 Husband.

Humphrie 2 sonne.

Edward 3 sonne.

John Repington 1 sonne.

Letice. — Sr Rob't Fisher K.

Anne ux. Dilkes.

Mary ux Sr Edward Littleton of Pillington Kt.

(Brasbridge.)

ARMS. *Vair argent and sable, a fess gules.*

CREST. *A staff raguly argent.*

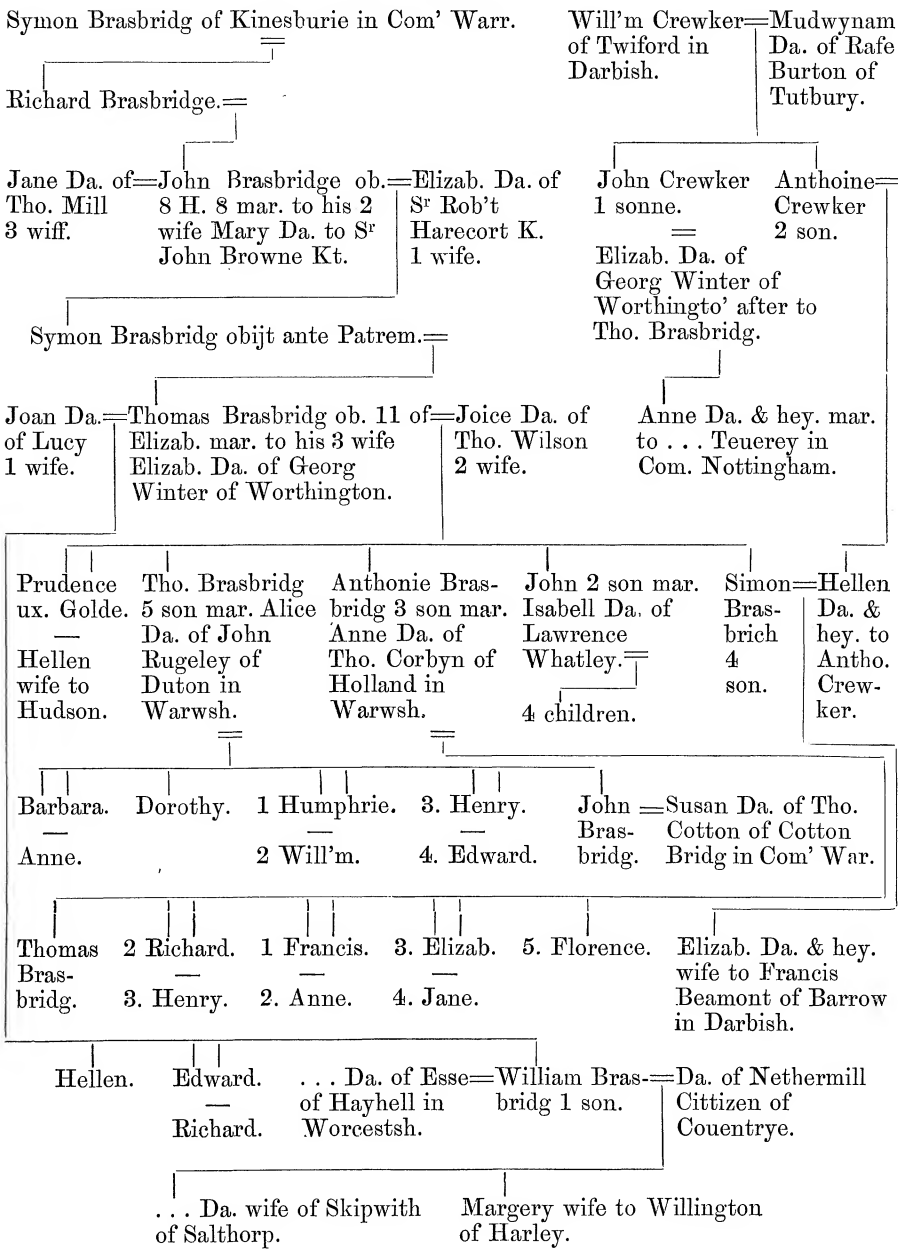

(Bradshaw.)

ARMS. *Argent, two bends between two martlets sable.*

Hugh Bradshaw of Moorebarne in Comitatus . . . Da. of Orme.
Leicest. descended out of Lancash.

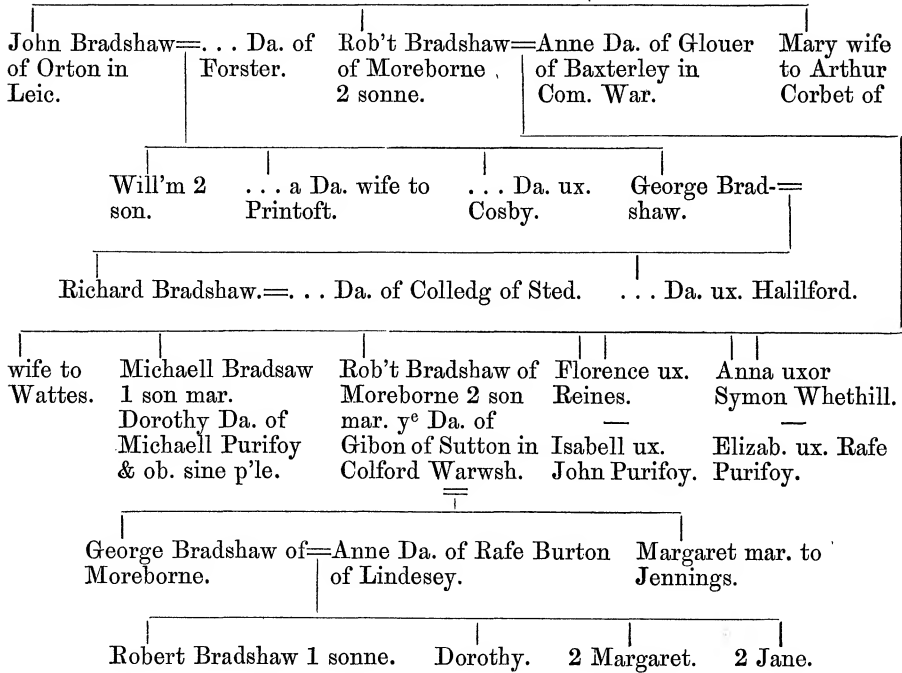
**(Whethill.)**

ARMS. *Quarterly:—1. Argent, on a fess or three mullets gules. (WHETHILL.) 2. Argent, a fess gules, in chief three mullets sable. (FLAUNDERS.) 3. Azure, a cross gules fretty argent. (SHEPEY.)*

John Whethill of Shepey in Com' Leic.=

Richard Whethill 4 H. 4 & 13=
H. 6. Margt. Da. & Coh. of John Flandus of
Flandus in Com' Warw.

Thomas Wheathill sonne & hey.=
A |

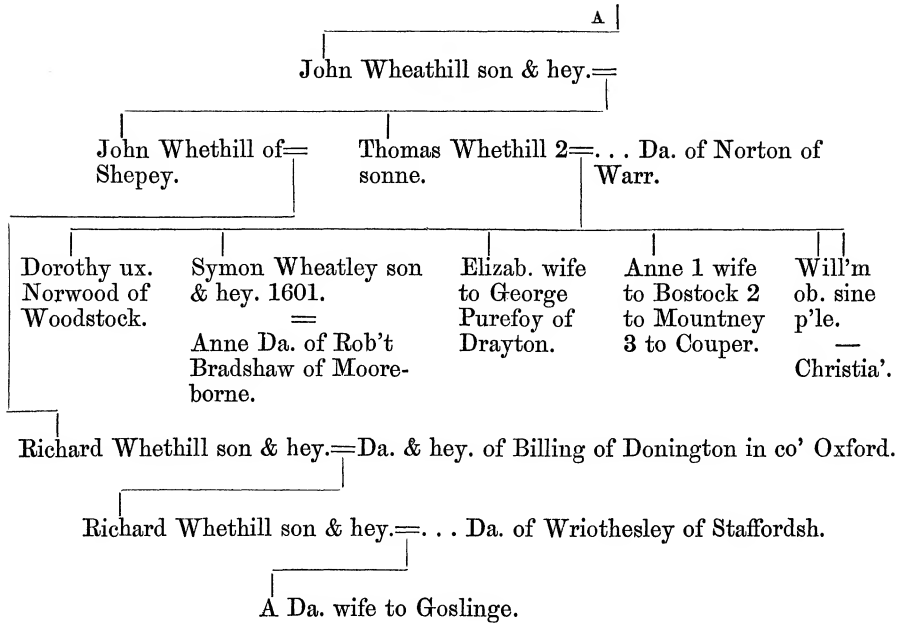

(Neele.)

ARMS. *Quarterly:—Gules, three greyhounds' heads erased argent, collared or; and or, a lion rampant double queuee vert.*

Patrick Sacheuerell of Hopwell in Com' Derby temp. E. 1. =

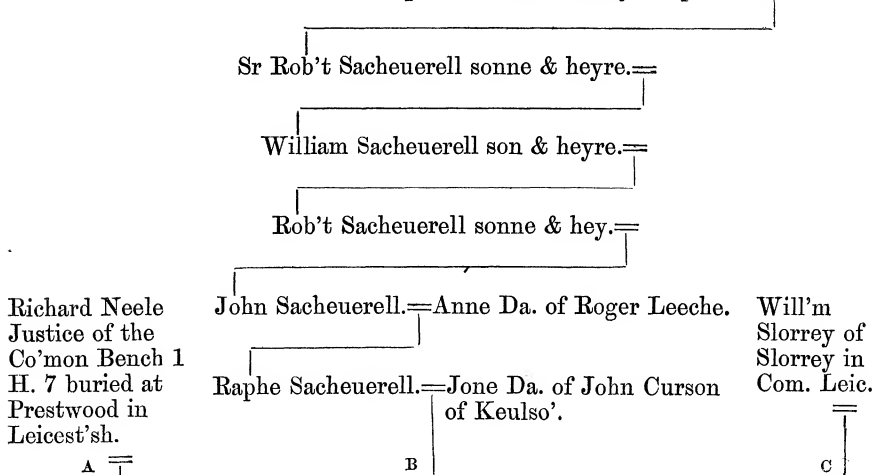

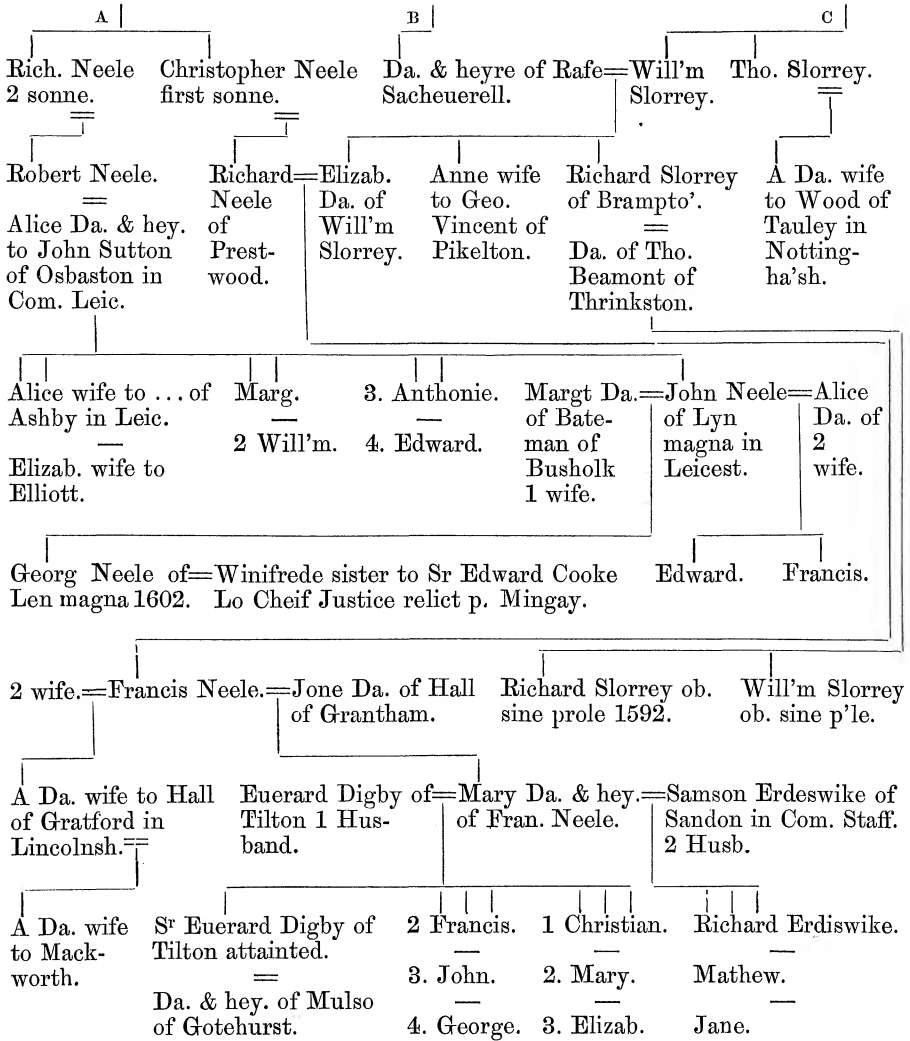

(Brabazon and Woodford.)

ARMS. *Gules, on a bend argent three martlets of the field.*

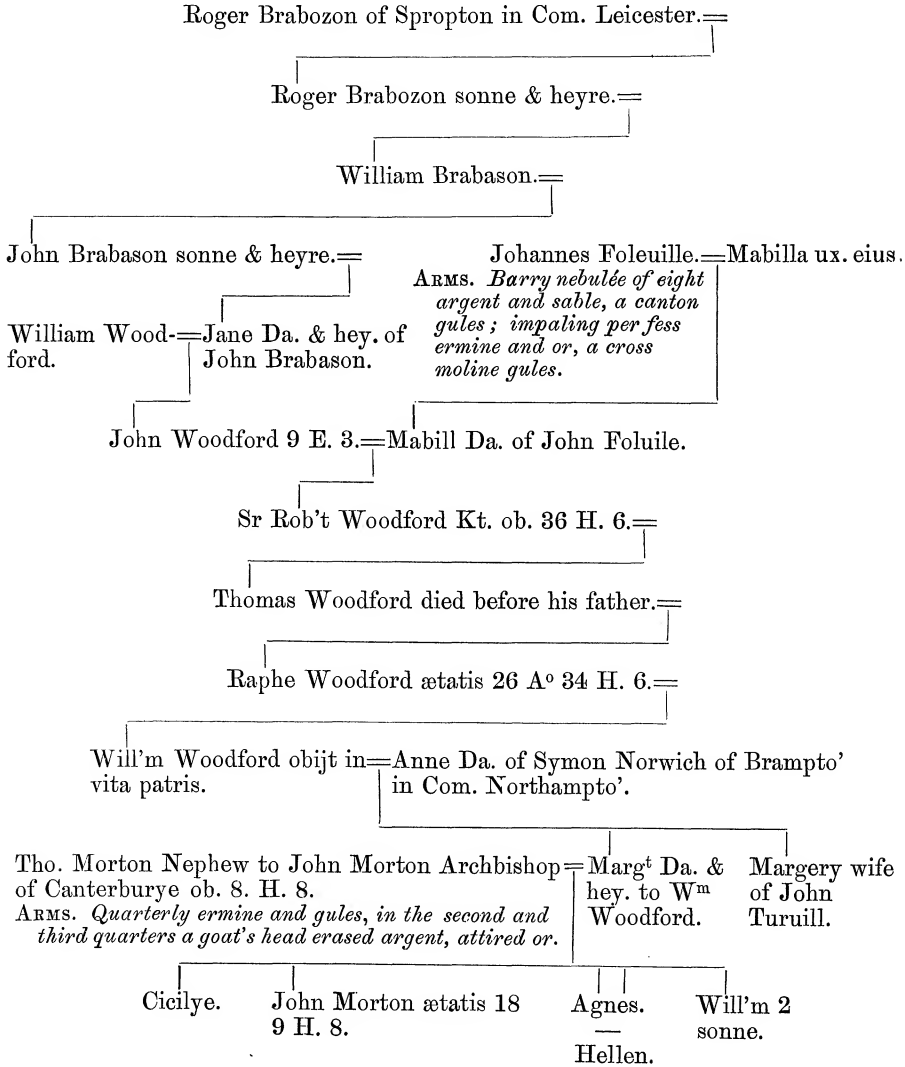

(Corbet.)ARMS. *Three crows (uninctured).*

Corbett of Ponsbury in Com. Salop. =

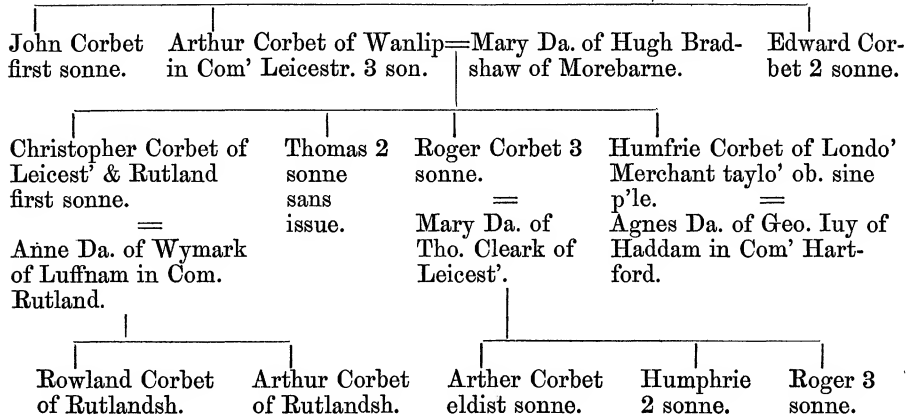
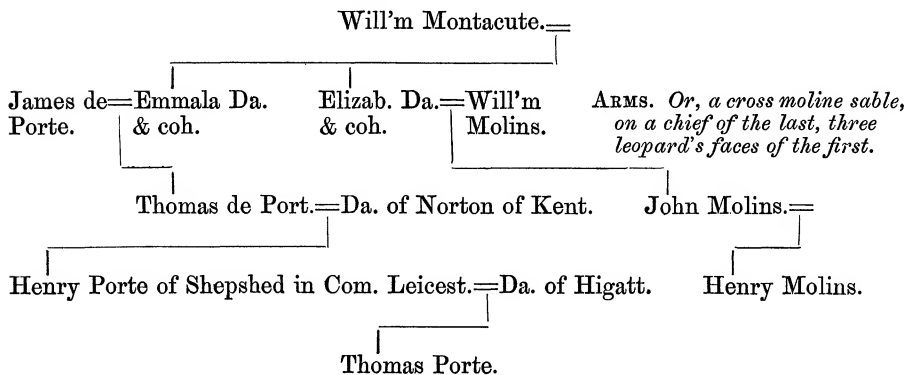
**(Porte.)**ARMS. *Argent, two bars azure, over all a saltire gules.*

(Brokesby.)

ARMS. *Quarterly:—1. Argent, two bars nebulée gules, on a canton of the last a mullet or, pierced. 2. Sable, three doves argent, in chief a mullet for difference. 3. Gules, a fess lozengy argent. 4. Or, on a bend argent between three torteaux as many bars azure. 5. Argent, two bars gules, in chief three torteaux. 6. Gules, a fess lozengy or. 7. Gules, three arches argent, their pedestals or. 8. Argent, a chevron between three eagles displayed gules. 9. Azure, a cross flory between four martlets argent.*

CREST. *A boar's head couped at the neck gules, bristled or.*

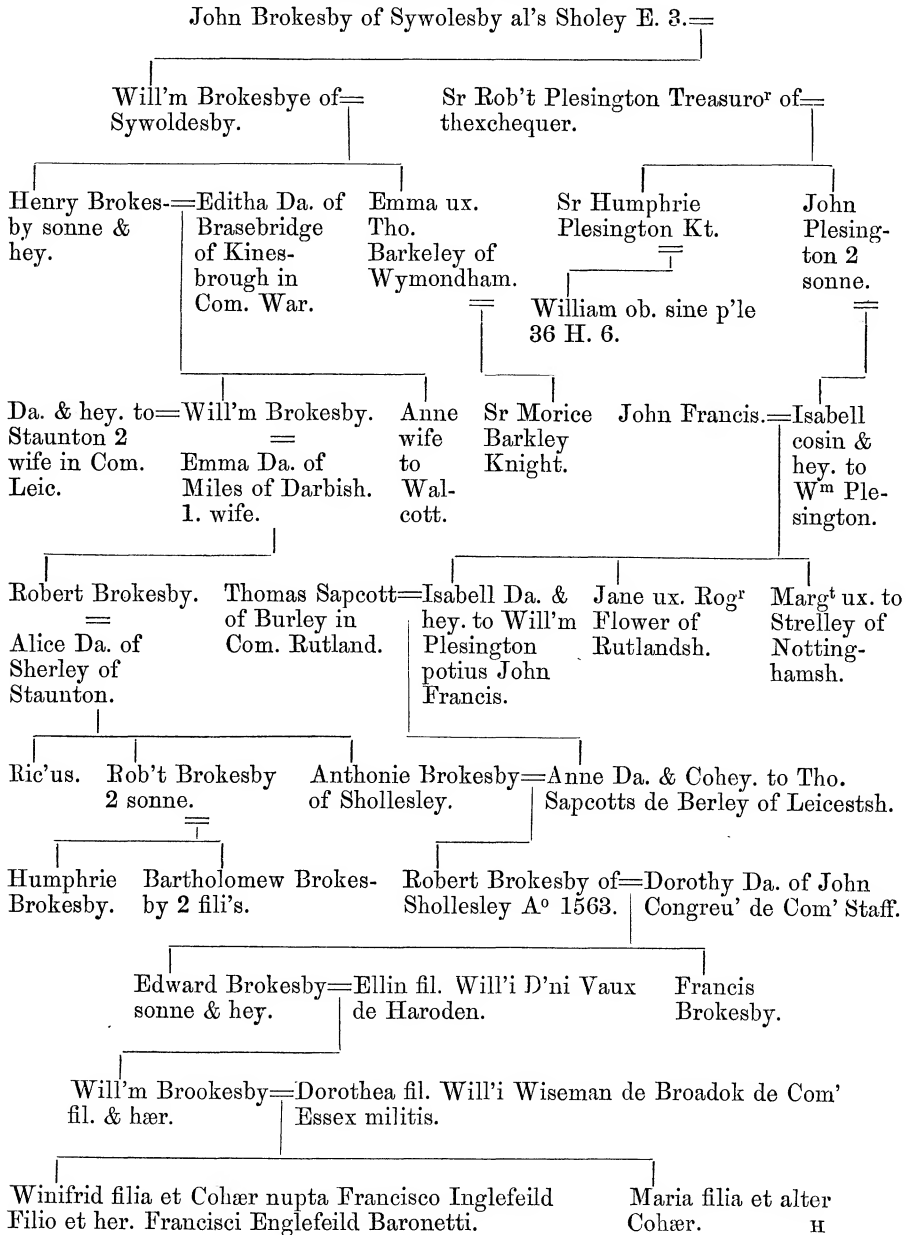

(Vincent.)

ARMS. Quarterly:—1. Azure, three quatrefoils argent. (VINCENT.) 2. Barry nebulée of six sable and or, on a chief argent three birds of the first. (GRIMSBY.) 3. Argent, a chevron between three boars' heads erased sable, within a bordure engrailed gules. (VULLIS.) 4. Argent, a cinquefoil azure. (MOTON.) 5. Or, three piles meeting in base gules, a canton vair. (BASSET.) 6. Or, a fess gules. (COLVILLE.) 7. Or, fretty sable each of the joints charged with a cross crosslet fitchéé argent. (CHAMPAGNE.) 8. Or, on a fess sable three water bougets argent. (BUGGE.)

CREST. A demi-ram rampant coupé sable, attired and collared or.

Thomas Grimsby of Dracklowe.= . . . Da. of Harecourt.

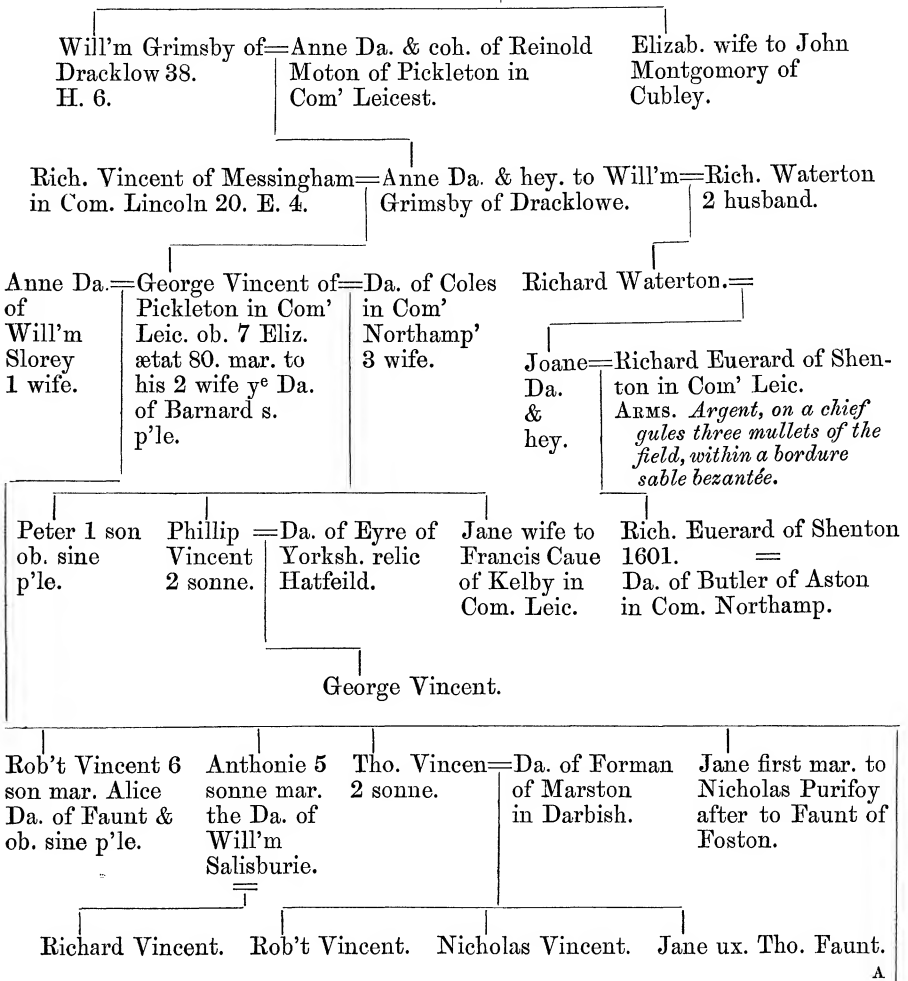

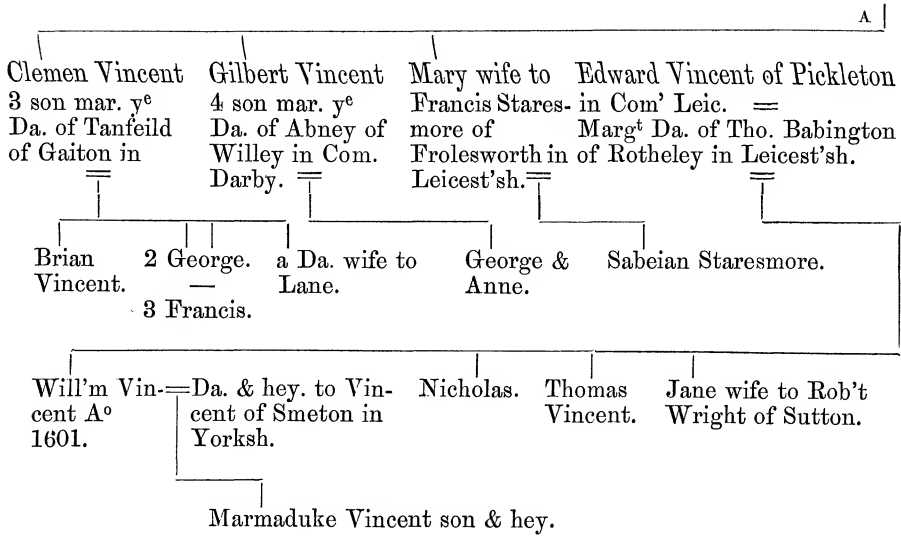

Chambers.

ARMS. *Quarterly*:—1. *Ermine, a fess chequy or and gules.* 2. *Sable, guttée d'eau, on a canton argent a mullet of the first.* 3. *Gules, a fess between three birds or, within a bordure engrailed of the last.* 4. *Gules, a chevron between three towers or.*

CREST. *Out of a coronet or, three holly leaves vert.*

“WHEATLEY. *Ar. on cheif gu. 3 garbs Ar.*”

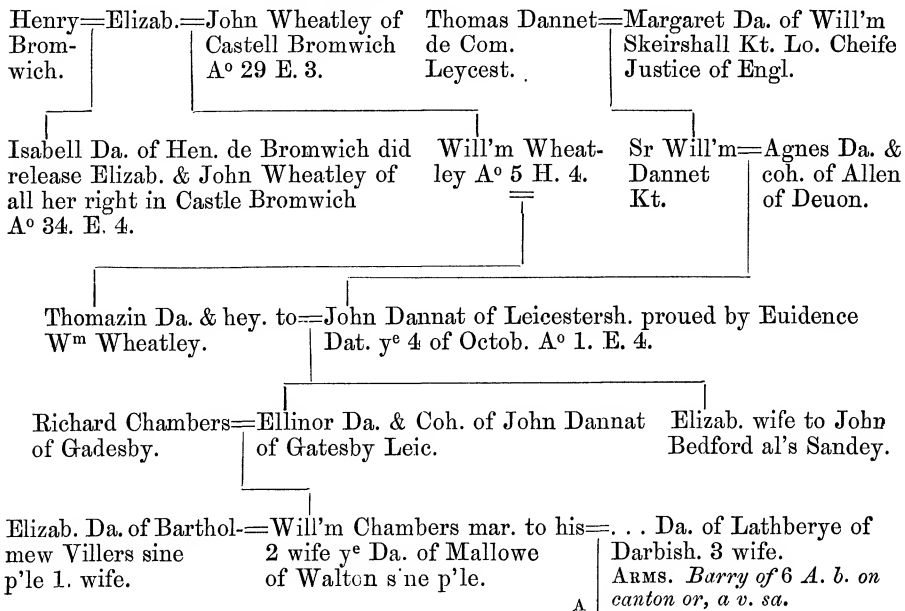

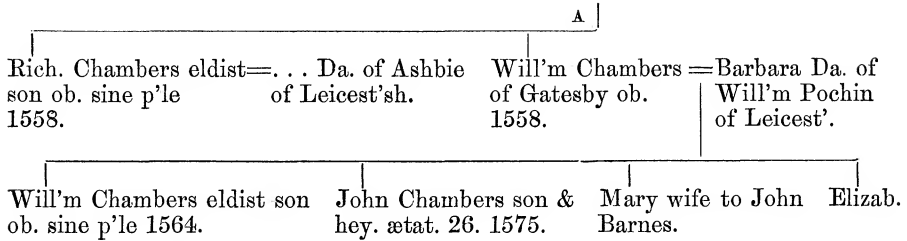

(Draper.)

ARMS. *Quarterly*:—1. *Argent, on a fess between three annulets gules a mullet of the field between two covered cups or.* 2. *Argent, on two chevrons sable between three escallops vert, six martlets or.* 3. *Ermine, on a chief azure three lions rampant or.* 4. *Ermine, a fess chequy sable and argent.*
 CREST. *A deater arm couped at the elbow erect, vested vert, slashed argent, holding a covered cup or.*

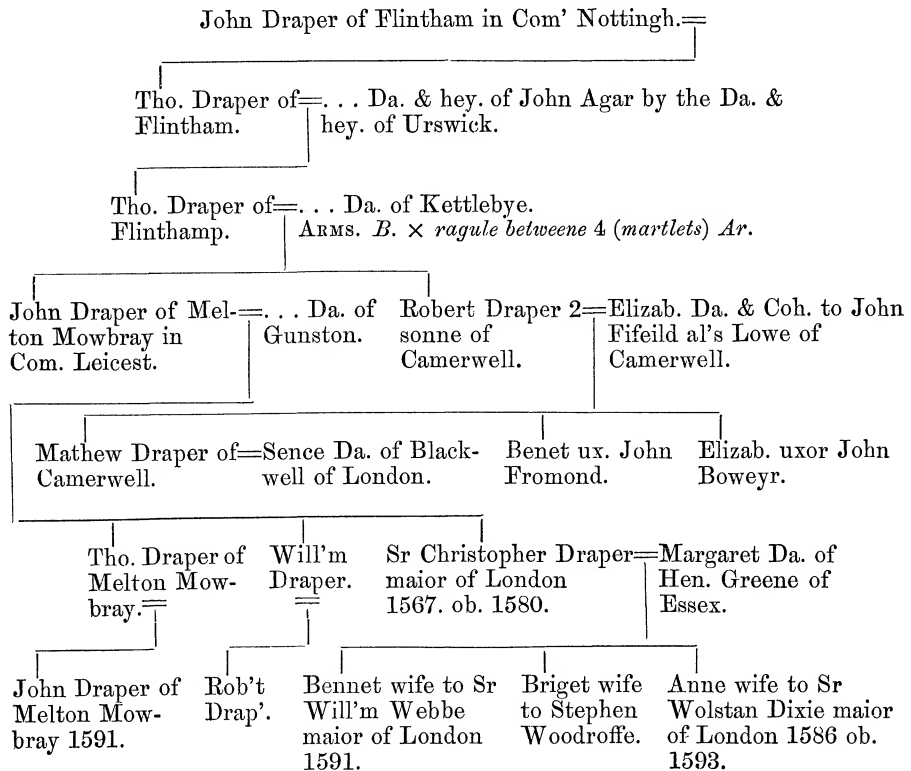

(Turbile.)

ARMS. *Quarterly*:—1. *Gules, three chevrons vair.* (TURVILL.) 2. *Argent, a maunch azure.* (FLAMVILL.) 3. *Or, on a fess sable three water bougets argent.* (BOUGGE.) 4. *Gules, three lozenges between six cross crosslets, fichée argent.* (FOUCHER.) 5. *Vair argent and sable, a canton gules.* (CHAMPAGNE.) 6. *Blank.* (STANTON.)

CREST. *A dove close proper, holding in its beak a branch of olive slipped vert, fructed with three olives or.*

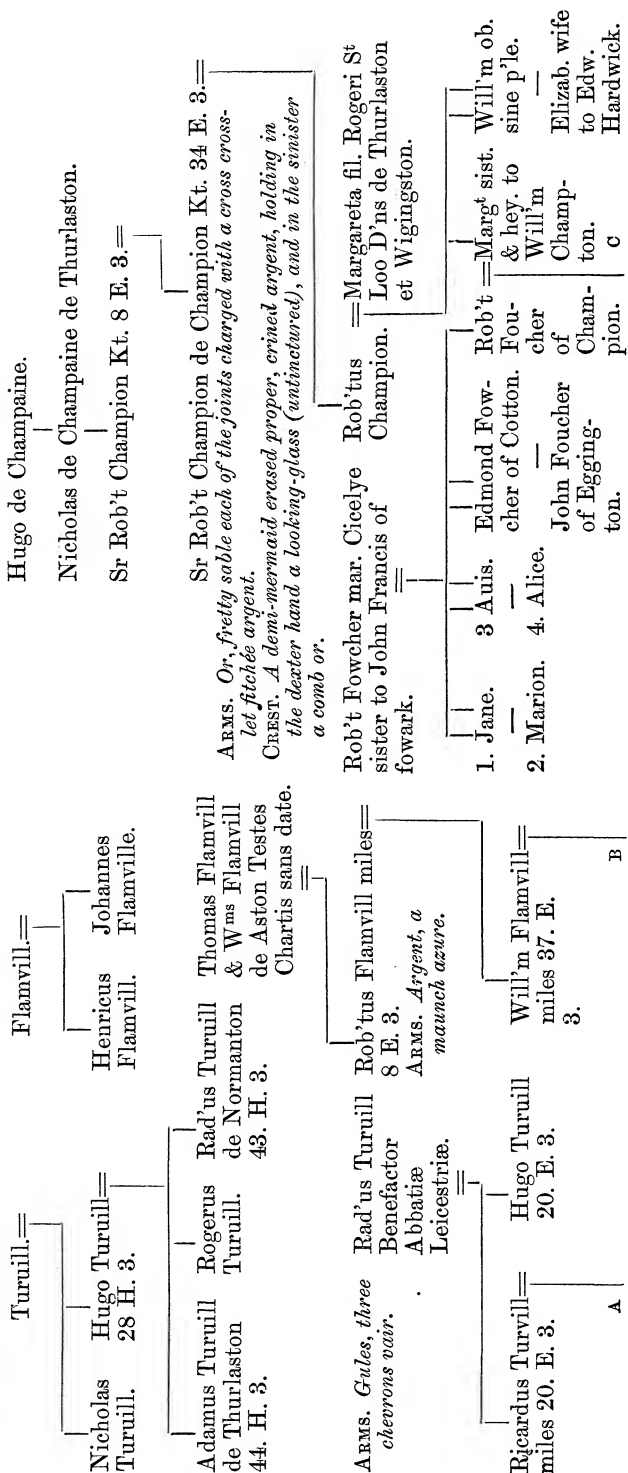

Turvill.==
 Nicholas Hugo Turvill==
 28 H. 3. Henricus Johannes
 Flamvill. Flamvill.

Adamus Turvill Rogerus Rad'us Turvill Thomas Flamvill
 de Thurlaston Turvill de Normanton & Wms Flamvill
 44. H. 3. 43. H. 3. de Aston Testes
 Chartis sans date.

ARMS. *Gules, three chevrons vair.*
 Rad'us Turvill Rob'tus Flamvill miles==
 Benefactor 8 E. 3.
 Abbatie Arms. *Argent, a maunch azure.*
 Leicester. Will'm Flamvill==
 miles 37. E. 3.
 Ricardus Turvill==
 miles 20. E. 3. Hugo Turvill
 20. E. 3.
 A B

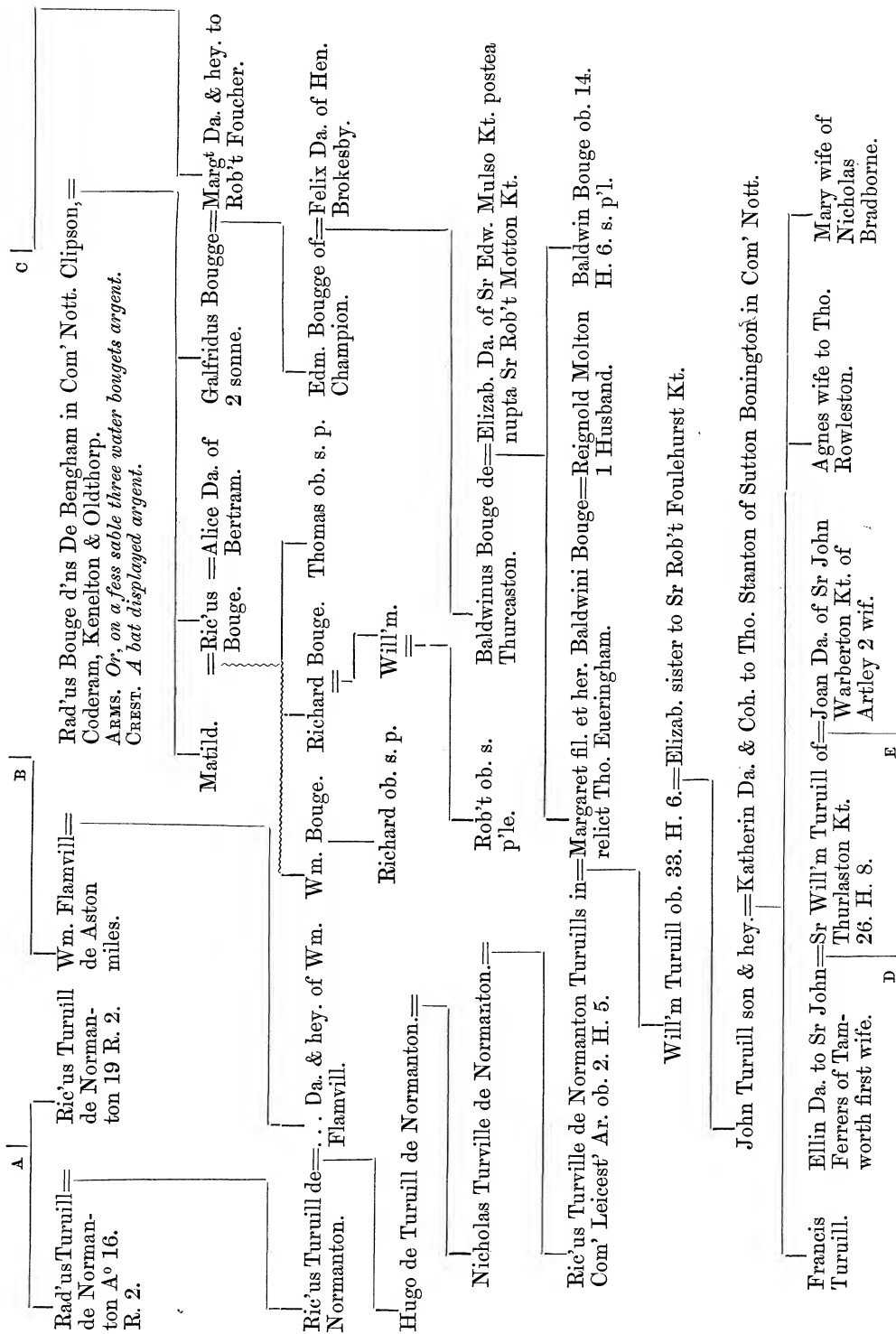

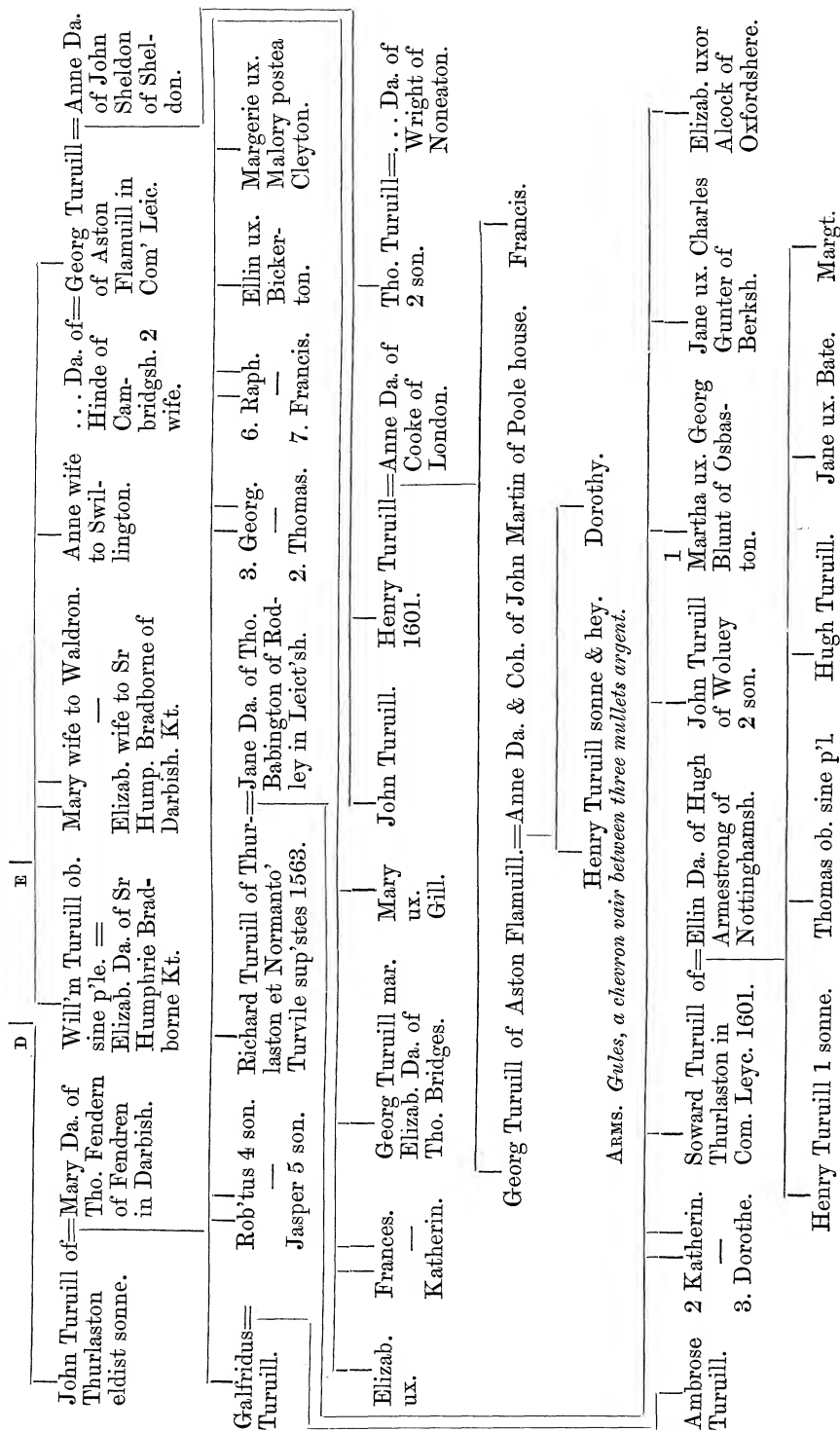

(Kebell.)

ARMS. *Quarterly:—Barry nebulée of six argent and sable, on a canton gules a crescent (untinctured); and gules, a chevron argent between three eagles displayed (untinctured).*

CREST. *A demi-eagle with wings displayed argent, gorged with a bar gemel gules.*

Walter Kebell de Humerston in Com' = Milicent filia Thomæ Hasilrigge de
Leic. in hund' de Goscot. | Nosey in Com. Leic.

Francis Kebell filius et hæres. = . . . filia . . . Sacheuerell de Com' Darb.

Henry Kebell of Homerston in Com' = Jane Da. of Edw. Griffin of Dingley
Leic. ob. 9. May 1571. | in Com' Northhampto'.

Elizabeth ætat 11 1571. | Margaretta ætat 10 1571.

(Burton.)

ARMS. *Quarterly:—1. Azure, a fess between three talbots' heads erased or. 2. Or, three mullets gules pierced. 3. Argent, a bend sable between three pellets. 4. Azure, an eagle displayed or. 5. Gules, a saltire engrailed between four mullets or. 6. Or, on a chief sable three griffins' heads erased argent. 7. Or, two bends gemelles sable. 8. Argent, a fess gules, in chief three mullets sable. 9. Gules, three eagles displayed or. 10. Vair argent and sable, a chevron gules. 11. (Field untinctured) fretty, each joint charged with a cross crosslet (untinctured). 12. Gules, on a bend or, three garlands vert.*

CREST. *On a mount vert, a beacon argent, cresset sable, ladder or, inflamed proper.*

Sr James Burton of Titbury in Com. Staff. Kt. Scutifer to K. R. 1.

John de Burton. =

Oliuer de Burton. =

Adam de Buton 2. E. 1. & 14. E. 2. =

Nicholas de Burton de Titbury 14 = Joan Da. of Creucure of Titbury.
E. 2 & 12 E. 3. | ARMS. "Or + unde g."

A |

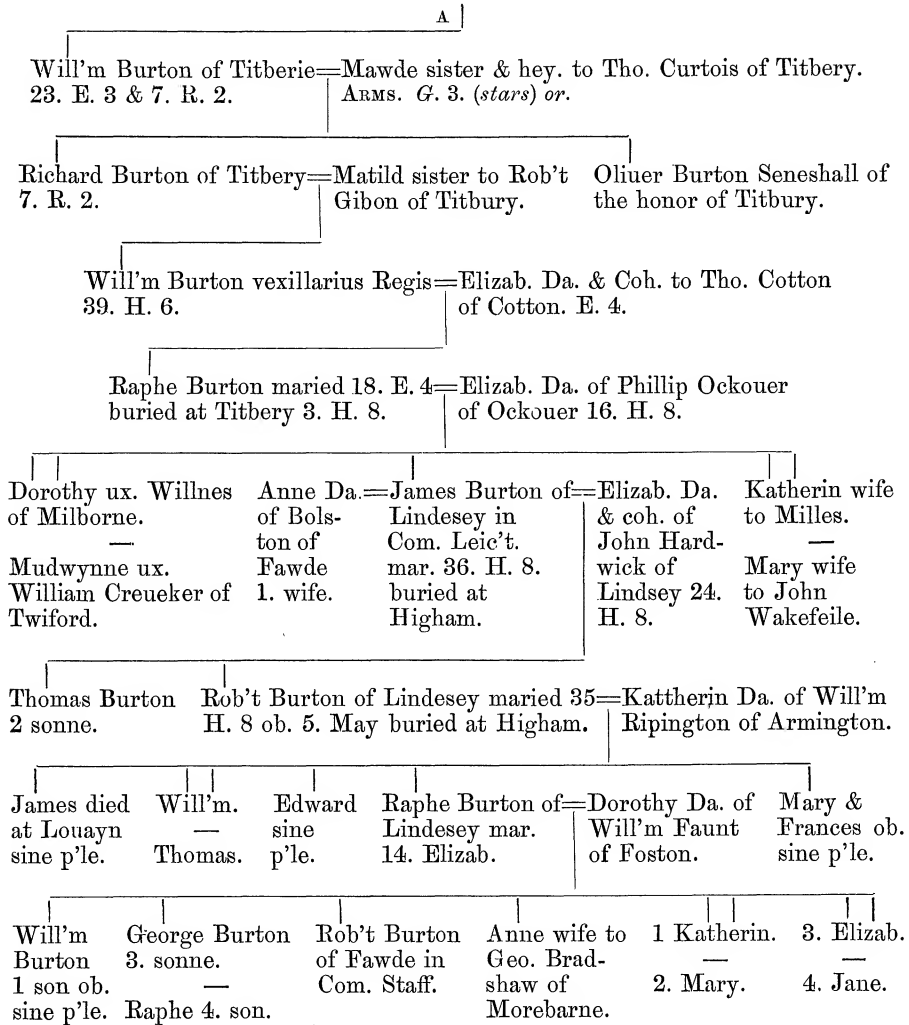

Moton.

ARMS. *Argent, a cinquefoil azure.*

Alexander Moton of Picketon in Com' Leicest'.

William Motton = Henry Motton 37. H. 3.

Raphe Motton 37. H. 3. = Julian ux. eius.

Rob't Motton = Sara ux. filia & heres.

Will'm Motton of Congerston,
Stapleto 6. E. 1. & 10. E. 2.

Symon
Motton.

Henry Motton Archdeacon
of Stowe 8. E. 3.

Sr Rob't Motton Knight = Alice Da. & coh. to Raphe
40. E. 3. Basset of Sapcotts

Alaine
Motton Kt | 17. R. 2.
6. H. 5. | 14. R. 2.

Sr Antikell Malory of Kirkby = Alice Da. & hey. of
Malory in Com' Leic' Kt ob. | John Driby relict
ante patrem 17. Ri. 2. | Rafe Basset 17. R. 2.

John Malory =

Elizabeth Da. & hey. uxor
John Fenton.

Sir Will'm Mallorye Kt. =
ARMS. *Or, a lion rampant gules.*

Roger Malory
2 sonne.

Tho. Malory 1 son.
10. E. 2.

A

B

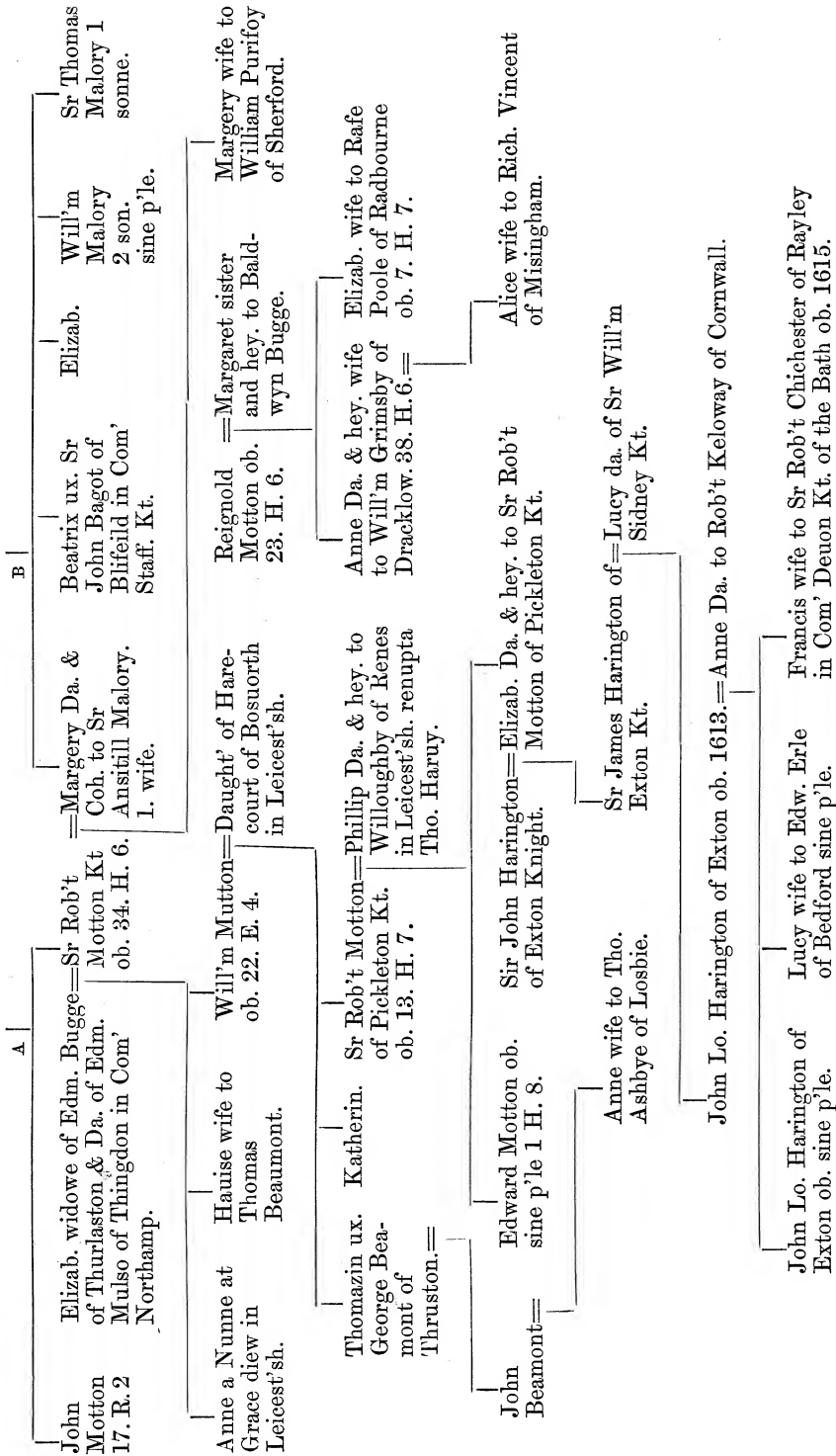

(Beamont.)

ARMS. Azure, a lion rampant between five fleurs-de-lis or.
 CREST. An elephant (uninctured) trapped or, surmounted with a tower (uninctured).

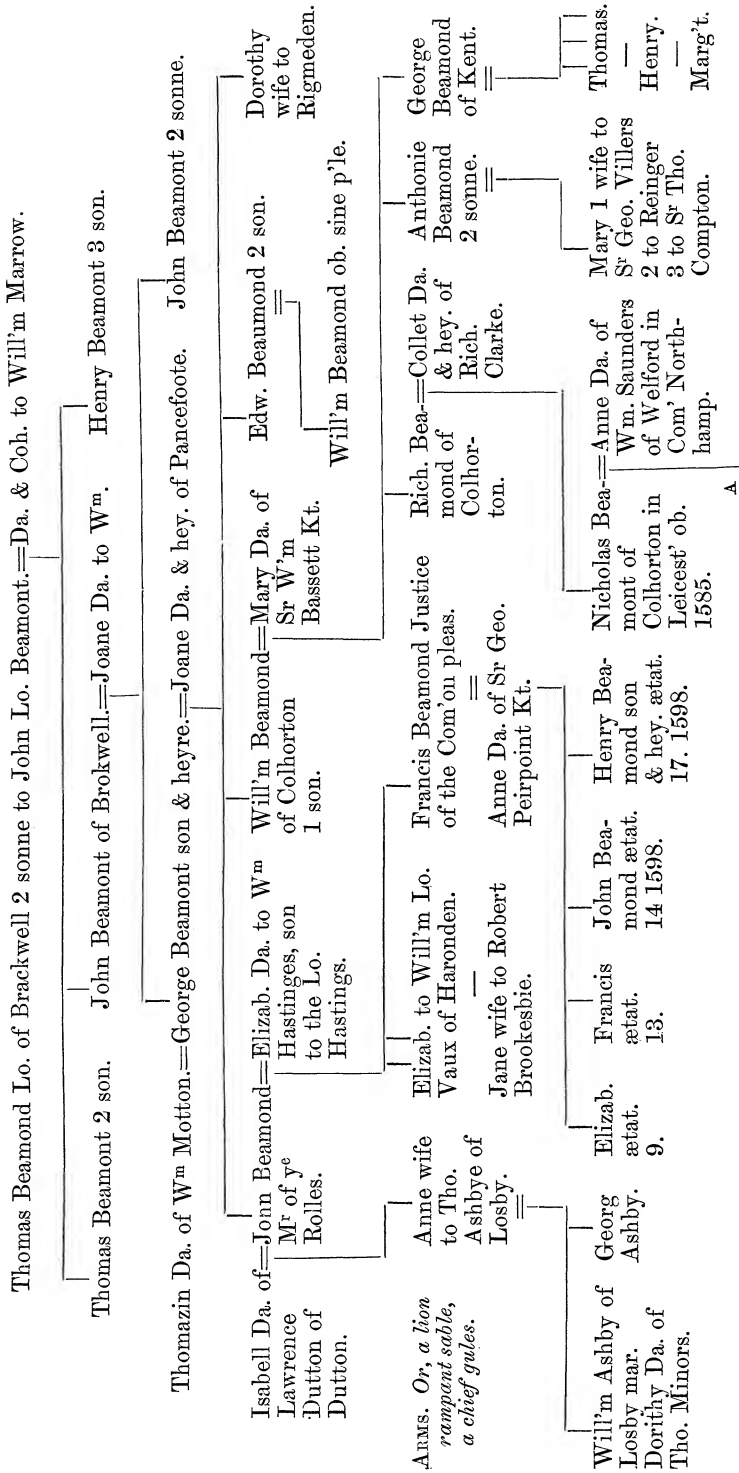

A	
Huntingdon Francis Beaumont Beaumont. 2 sonne.	Sr Henry Beaumont of Colher—Da. & hey. of Lewis ton Kt. 3 sonne.
Will'm Beaumont 2 sonne.	Sr Tho. Beaumont of Staung—Katherin Da. & hey. of Farnham of Staugham.
Thomas Beaumont sonne & hey. Knight of Cole Orton in the countie of Leicester A ^o 1619 married Elizabeth dau'r and heire to Hen. Sapcote of Elton in co. Hunt. in Com. Leic.	Mary married to Richard Francis ux. Sr Paramour de Loseby Wolstan Dixie Kt. John Ashborn- ham Kt.
Sapcote Beaumont son & heire æt. 6.	Henry ætatis. 4.
Thomas ætatis. 2.	Robert ætatis. 1.
Thomas ætatis. 1.	Thomas. Jane s. p.
Thomas 3 sonne.	Elizabeth. Frances. Katherine. Maria. Elianor.
Anne uxor John Dillon of fard- ringhay.	Isabell uxor Hugh Snowse of Belton in Yorksh.
Tho. Beaunt fl. et hæar. æt. 11 1619.	Hen. Beaumont sonne & heyre mil. duxit Elizab. fl. Willi' Turpen de Knopftoft in Com' Leic. militis.
2 Willm's æt. 9.	1 Elizab. 6.
3. Henricus. 7.	2. Fran. 4.
1 Elinor.	Jane uxor W ^m Tempell of London Merchant.

Humphrey.

ARMS. *Quarterly* :—*Gules, a cross bottonée argent quarter pierced of the field and charged in each end with three escallops sable ; and azure, a bend between four leopards' faces or, a crescent for difference.*

CREST. *A harpy, argent, crined or, with wings displayed of the last.*

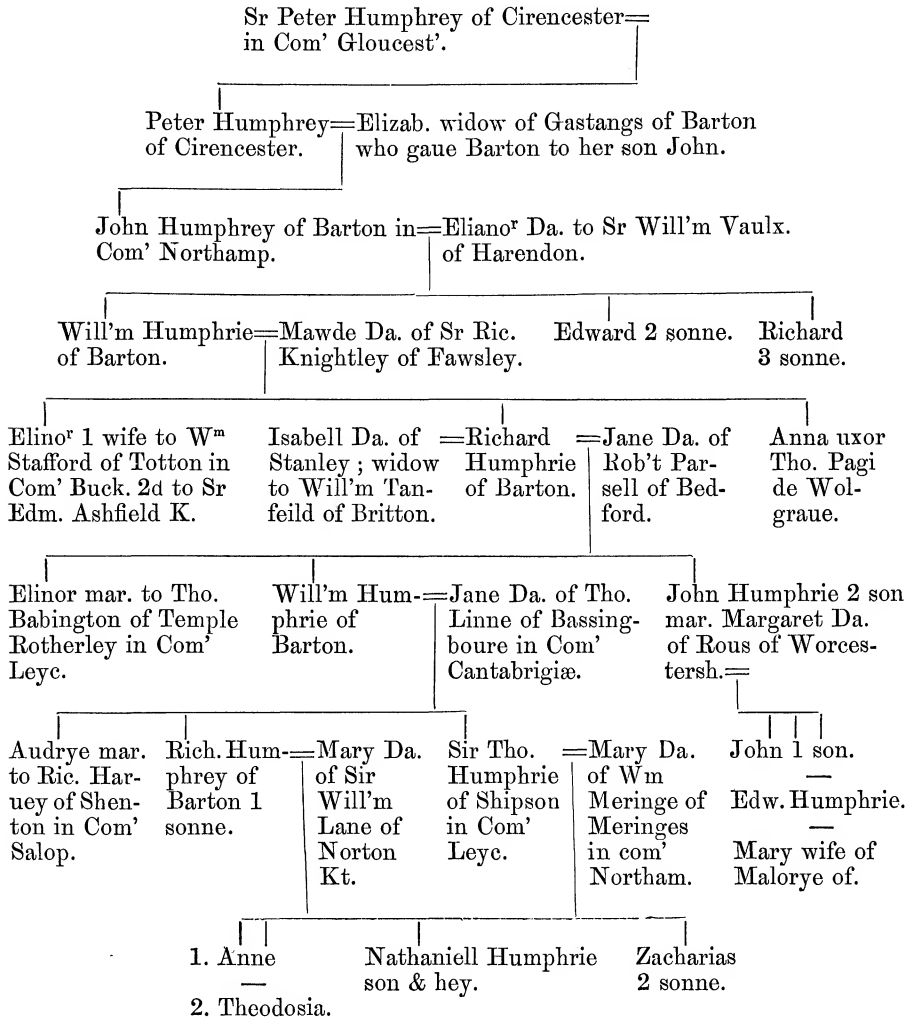

Pace.

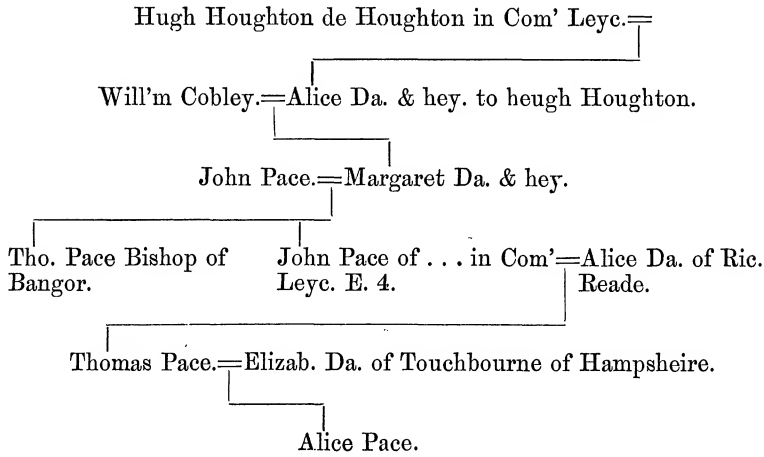

Prestwich.

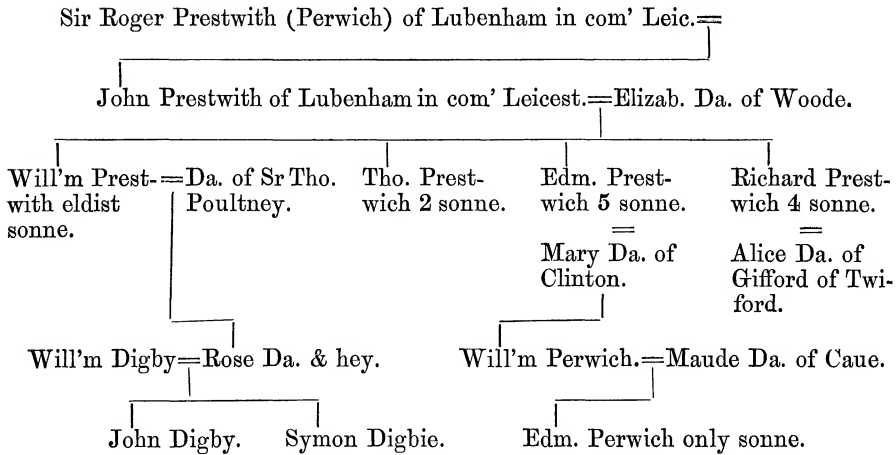

(Dannet.)

ARMS. *Quarterly* :—1. *Sable, guttée d'eau a canton ermine.* (DANNAT.) 2. (*Field untingured*) *on two bars, six lions rampant (untingured).* (DELAHAY.) 3. *Azure, on a bend cotised (untingured) three eagles displayed argent.* (BEKNAP.) 4. (*Field untingured*) *two bends gules.* 5. *Azure, three birds rising argent.* (SUDLEY.) 6. *Bendy of six or and azure.* (MONTFORT.) 7. *Gules, a fess chequy argent and sable, between six cross crosslets fitchée or.* (BUTLER.) 8. *Argent, Barry of six nebulée gules, within a bordure engrailed sable, bezantée.*
 CREST. *A greyhound's head erased argent, collared and ringed gules.*

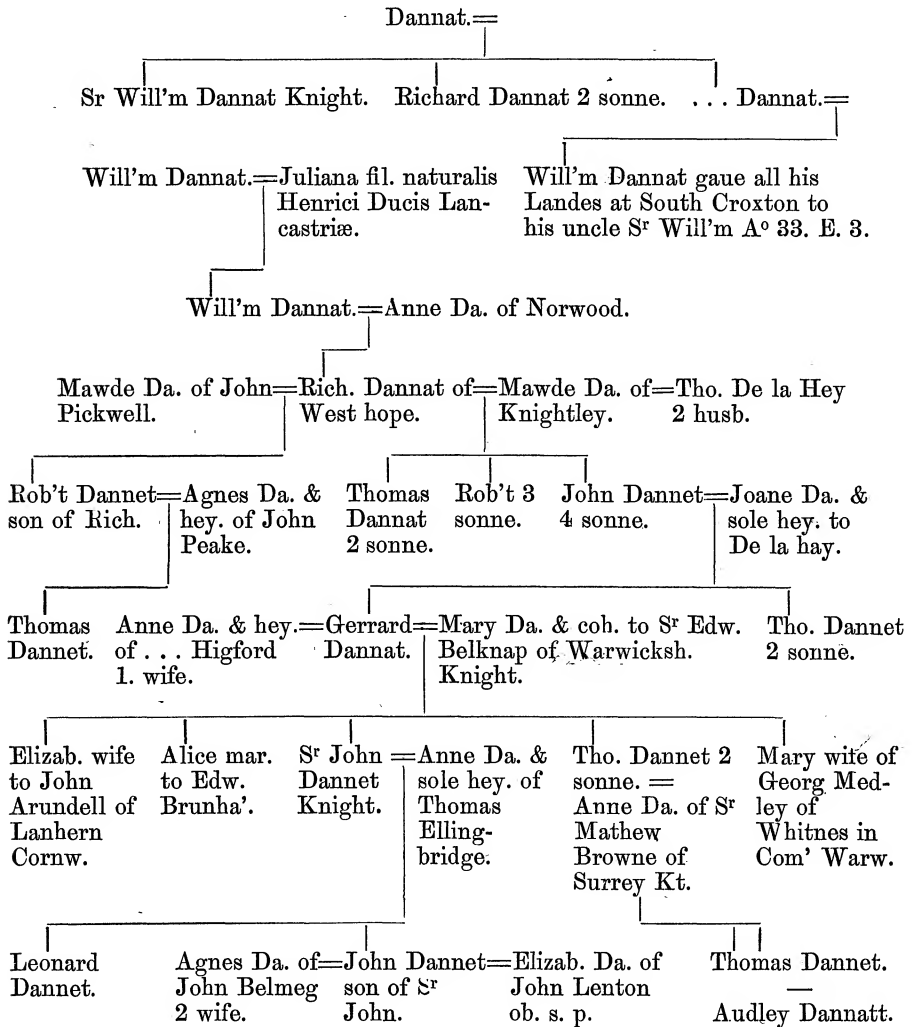

(Brooke.)

ARMS. *Quarterly:—Or, a cross engrailed per pale gules and sable; and argent, a chevron sable between three bucks' heads caboshed gules, a crescent for difference.*

CREST. *A badger (uninctured), charged on the flank with a crescent for difference.*

Thomas Brooke of Leighton in Com. Cestriæ.=Anne Da. of . . . Venables.

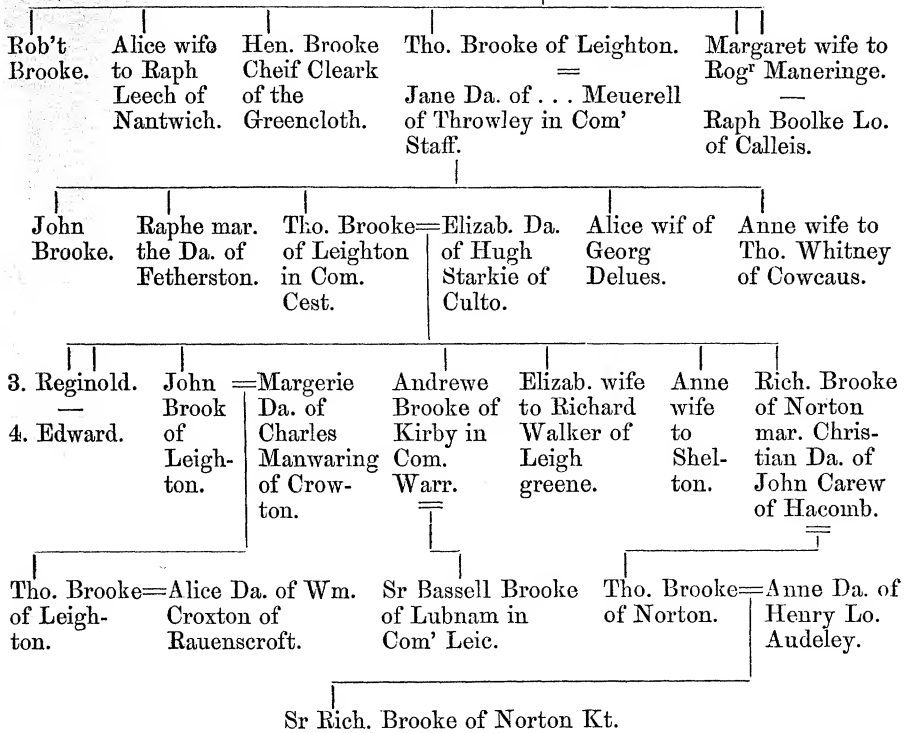

(Pecche.)

ARMS. *Azure, a lion rampant double queueé ermine, on a canton or, a mullet gules.*

John Pecche of Kingsthorp & Sherowhall in Com. Leic. & Derby.

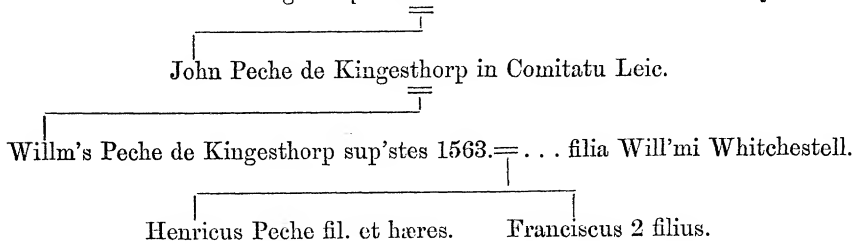

Smith al's Harris.

ARMS. Quarterly:—1. *Gules, on a chevron or, between three bezants as many crosses pattée fitchée sable; and argent, three piles meeting in base gules between twelve martlets sable, three and three in chief, and three and three in base palewise.*
CREST. *Out of a ducal coronet or, an Indian goat's head argent, eared sable, bearded and attired of the first.*

ARMS. *Gules, on a chevron or, John Smith al's Harris of=Dorothie Da. of Ric.=Henry Poole Kt
 Withcottes in Com' Leic.
 Cave of Stamford in
 Com' Northamp.*

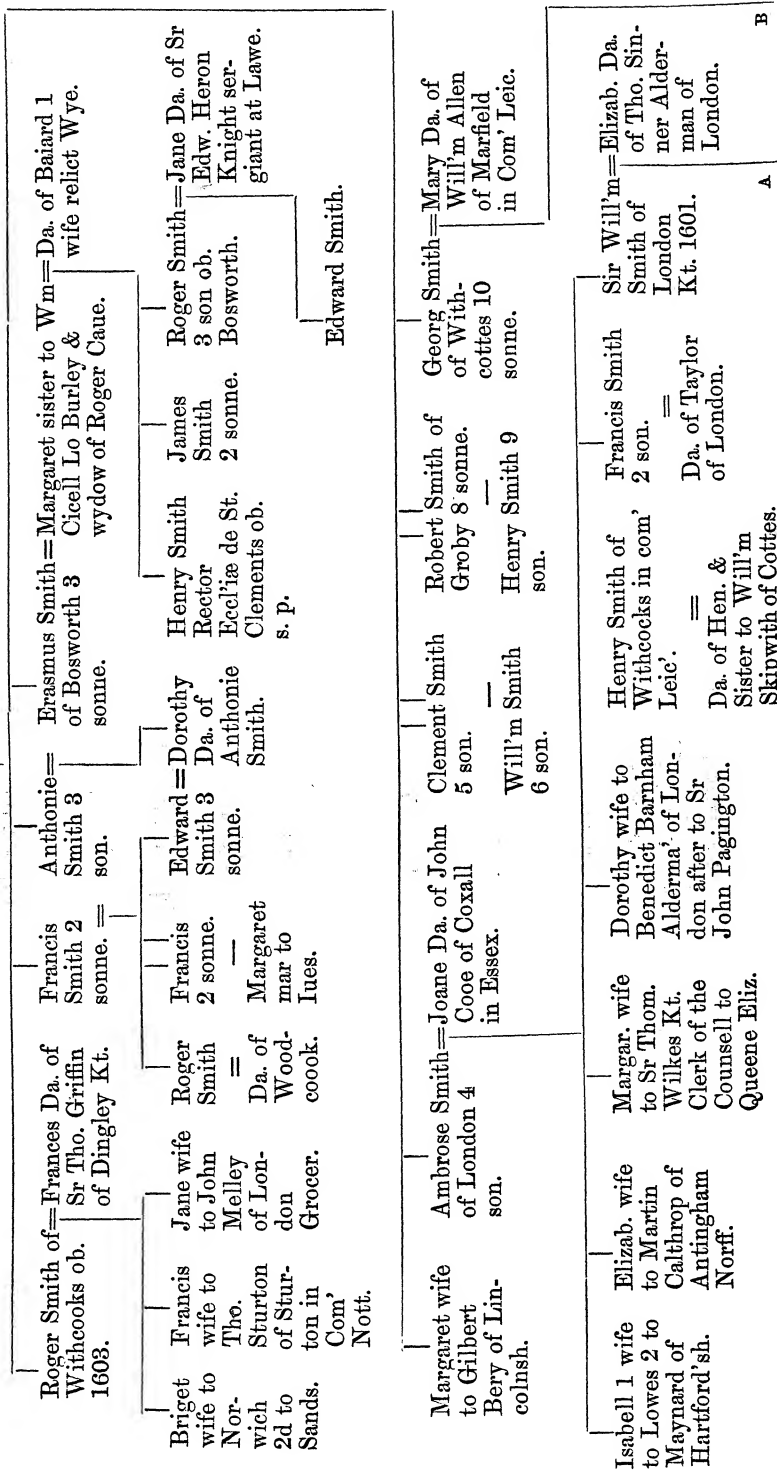

A B

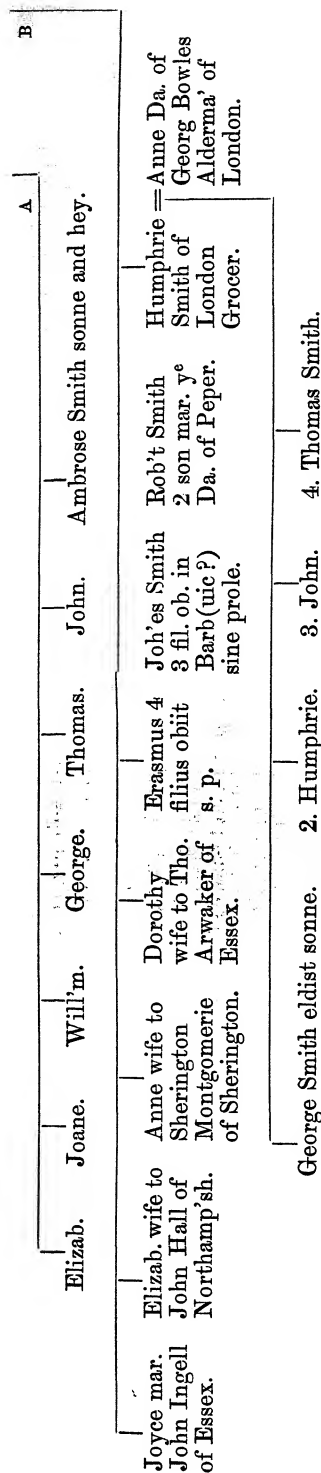

(Belgrave.)

ARMS. Quarterly:—1. Gules, a chevron ermene between three mascles argent. 2. Argent, three pairs of bellows sable. 3. Sable, three escallops argent. 4. Ermene, three mascles conjoined in fess sable. 5. Or, on a fess gules three fleurs-de-lis of the field, in chief as many fleurs-de-lis of the second. 6. Gules, a pelican in its piety argent.

CREST. A ram's head couped at the neck (untinctured).

Johannes Belgrave fl. et hæ. Ric'i = Johanna filia et unica hæ. Thomæ Swyke burges of leicest.

Georgius Belgrave filius et her. = Dorothea filia Lawrencij Sanders.

Johanna filia Rob'ti Farnham de = George Belgrave filius = Maria filia Rob'ti
Querne in Com' Leic' ux. 2. et hæres. Chantrell ux. 1.

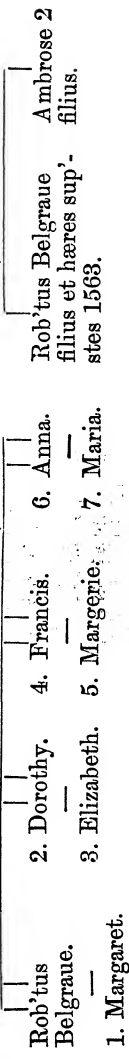

1. Margaret.

(Belgrave.)

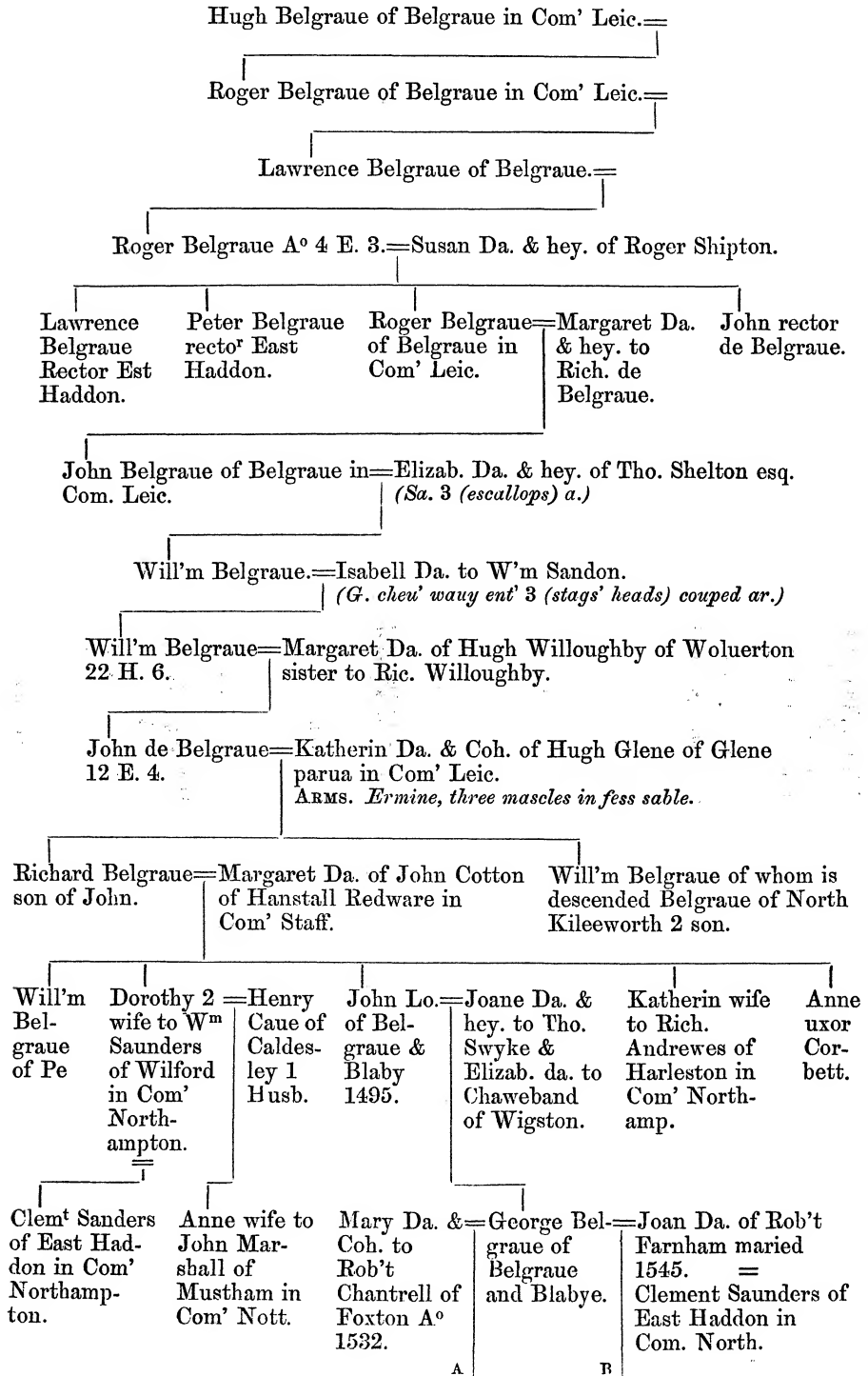

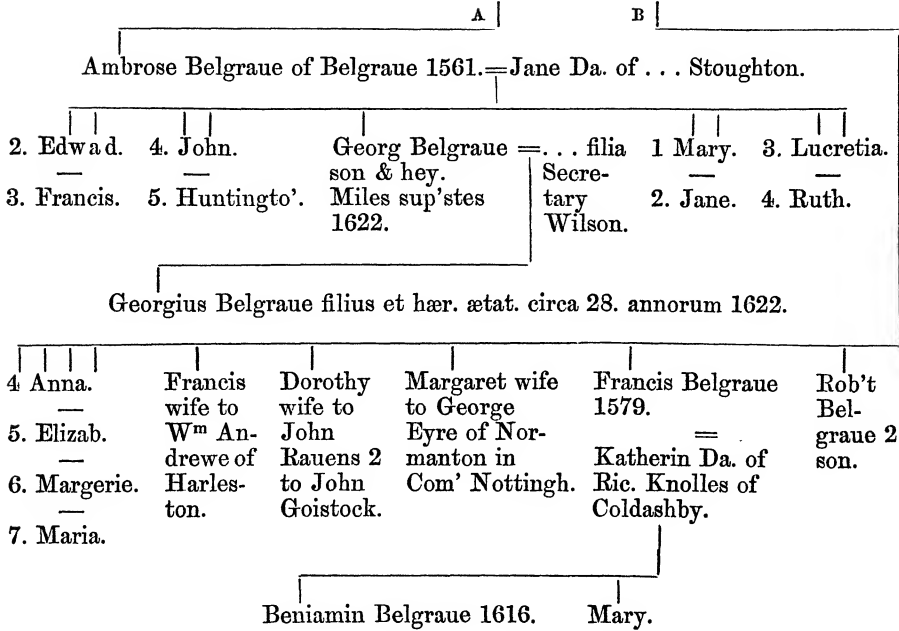

ARMS. Quarterly:—1. Gules, on a bend argent three lions' heads erased sable. (TURPEN.) 2. (Field untingured) a fess chequy or and sable between six cross crosslets (untingured). (KINSMAN.) 3. Argent, a cross flory between four crescents gules. (TILLEY.) 4. Gules, a cross flory argent. (PAWCOE) 5. Quarterly or and barry of six argent and gules, within a bordure sable, charged with ten fishes naiant of the second. (GOBEON.)

CRESTS. 1. A griffin passant with wings endorsed or, guttée de sang, unguled azure. 2. A lion's head erased sable, ducally gorged or. 3. On a wreath or and gules, a cockatrice's head coupéd argent, beaked, combed, and wattled of the second. 4. A shoveller's head coupéd (untingured).

(Poultney.)

ARMS. *Quarterly*:—1. *Argent, a fess dancettée gules, in chief three leopards' faces sable.* (POULTNEY.) 2. *Argent, a pale lozengy gules.* (WHYMALL.) 3. *Quarterly gules and or, in the first quarter a lion passant argent.* (DANIELL.) 4. *Barry of six argent and gules, over all a bend (uninctured).* 5. *Per fess crenellée azure and or, three eagles displayed counterchanged.* 6. *Argent, a lion rampant sable, crowned or, in dexter chief a crescent for difference.* 7. *Ermine, a fess between three lozenges gules.* 8. *Argent, a chevron between three martlets sable.* 9. *Field (uninctured), three bars (uninctured), on a canton (uninctured) a bend lozengy or.* 10. *Argent, three bends gules.*

CREST. *A lion's head erased guardant sable.*

Adam Neale de Weston in Com' Sussex al's Adam Neale de Poultney. = Matildis.

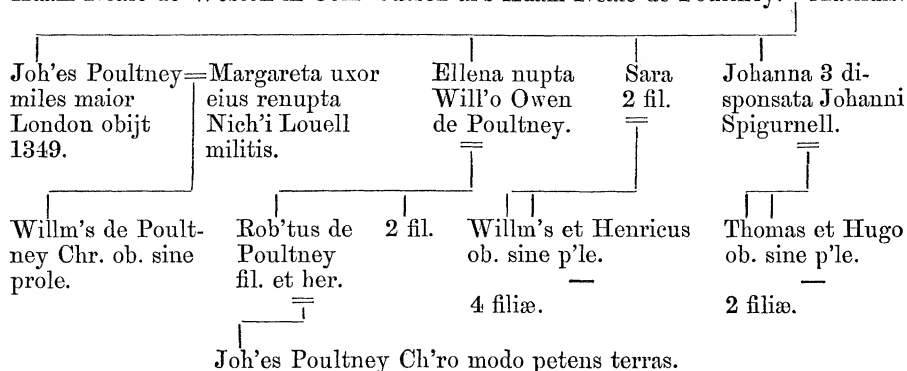

* ARMS. *Quarterly*:—1. *Argent, a chevron between three hazel leaves vert.* 2. *Argent, three squirrels sejant gules.* 3. *Gules, three herons argent.* 4. *Gules, a chevron between three martlets or.* 5. *Argent, a cinquefoil sable.* 6. *Vair, argent and sable, a canton gules.* 7. *Or, a bend between six martlets gules.* 8. *Paly of six or and gules, on a bend sable three horse-shoes argent.* 9. *Vair, argent and sable.* 10. *Sable, a lion rampant argent.* 11. *Argent, on a bend engrailed sable three mullets of the field.* 12. *Argent, a whirlpool azure.* 13. *Lozengy or and azure, over all a chevron gules.* 14. *Argent, on a chief gules three bezants.* 15. *Gules, a lion rampant ermine.* 16. *Argent, a chevron ermine between three dice azure, charged with three spots of the field.*

CREST. *On a cap of maintenance gules, turned up ermine, a man's head coupé in dexter profile proper, crined and bearded or.*

These Coates were thus
Marshallled for Sr Arthur
Haselrigg Kt. & Barronett
1644.

* These arms tricked by Henry Parker.

(Gerueis.)

Willm's Jerueis de Thorpe Langton in Com. Leic. A°. 37. E. 3.

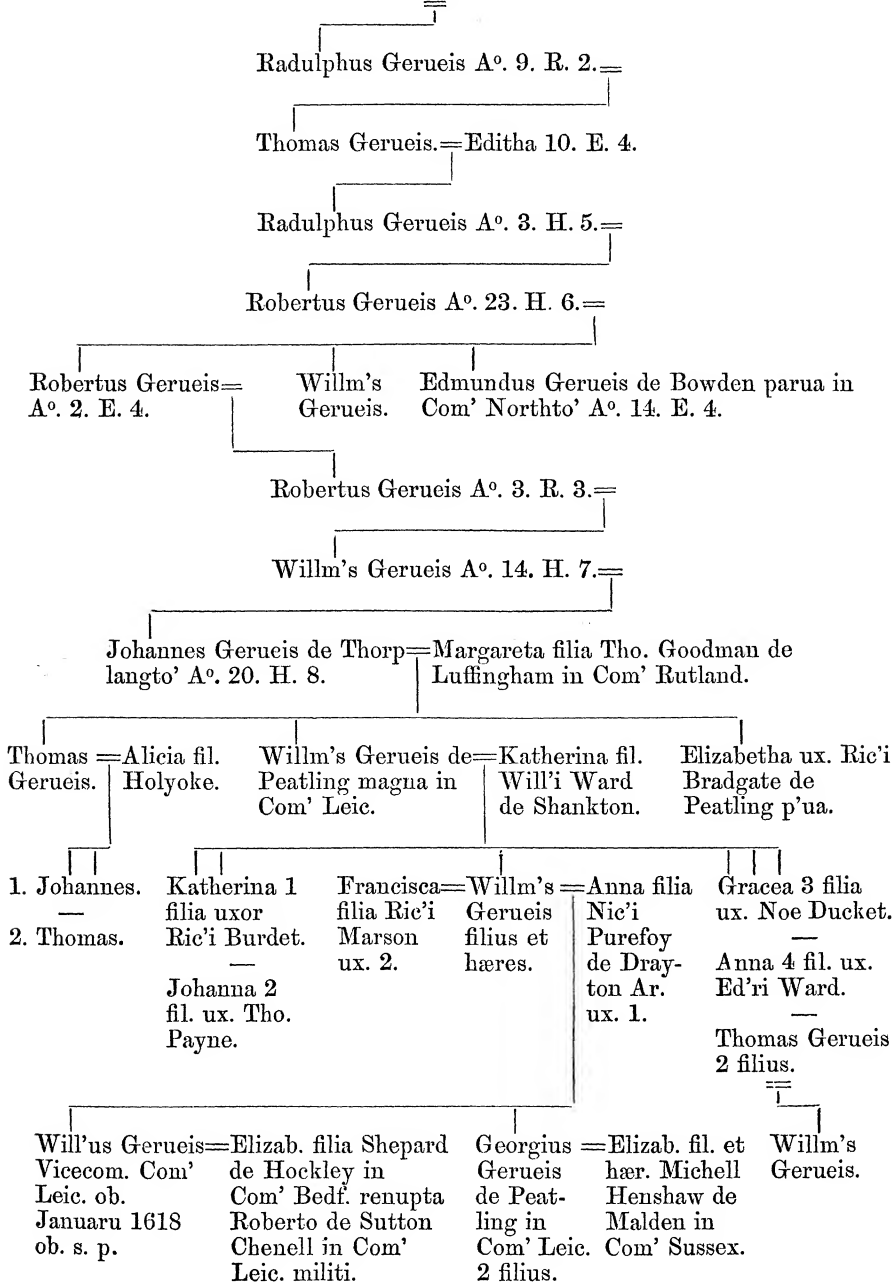

(Hastings.)

ARMS. (*The whole uninctured*). 1. *A maunch*. 2. *Per pale a saltire engrailed countercharged*. 3. *Quarterly, France ancient and England*. 4. *A saltire, in chief a label of three points*. 5. *Three lozenges in fess*. 6. *An eagle displayed*. 7. *A lion rampant between ten fleurs-de-lis, three, two, and three*. 8. *England within a bordure*. 9. *A fess between six cross crosslets*. 10. *Chequy, a chevron ermine*. 11. *Quarterly uninctured and a fret, over all a bend*. 12. *Three chevrons*. 13. *Two bars, in chief three roundles*. 14. *Per pale indented, over all a chevron*. 15. *Paly of six wavy*. 16. *Two bars, in chief three roundles*.
 CREST. *A bull's head erased, ducally gorged (uninctured)*.

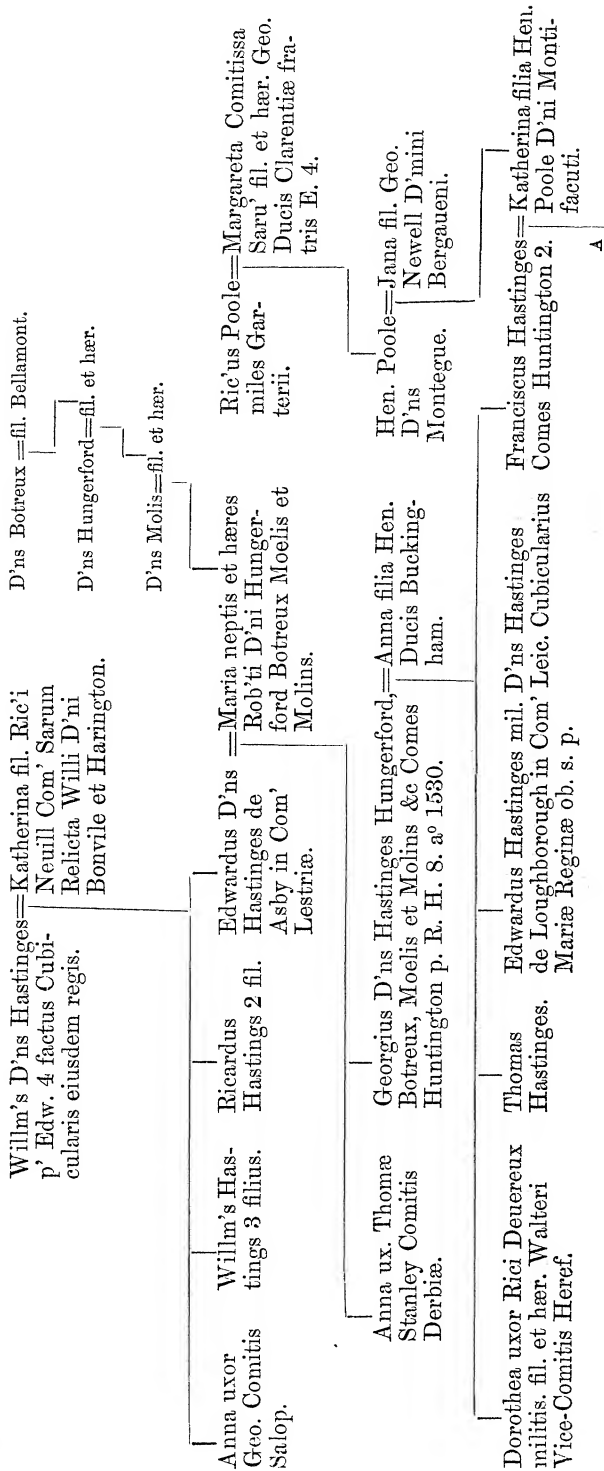

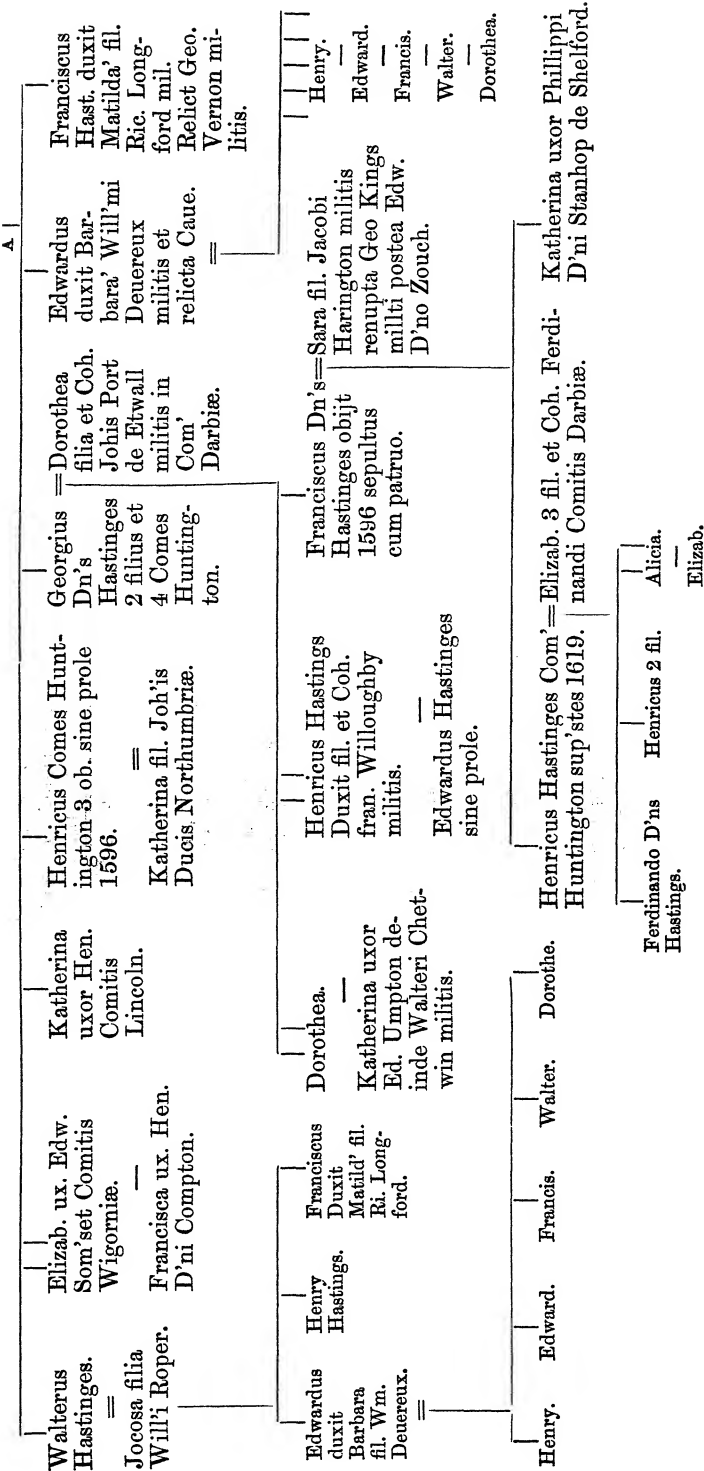

(Gray.)

ARMS. *Quarterly*:—1. *Barry of six argent and azure, in chief three torteaux, over them a label of three points gules.* 2. *Or, a maunch gules.* 3. *Barry of ten (untinctured), an orle of eight martlets.* 4. *Azure, a cinquefoil ermine.* 5. *Vair or and gules.* 6. *Argent, a fess and canton conjoined gules.* 7. *Sable, six mullets argent, three, two, one.* 8. *Sable, a fret argent.*

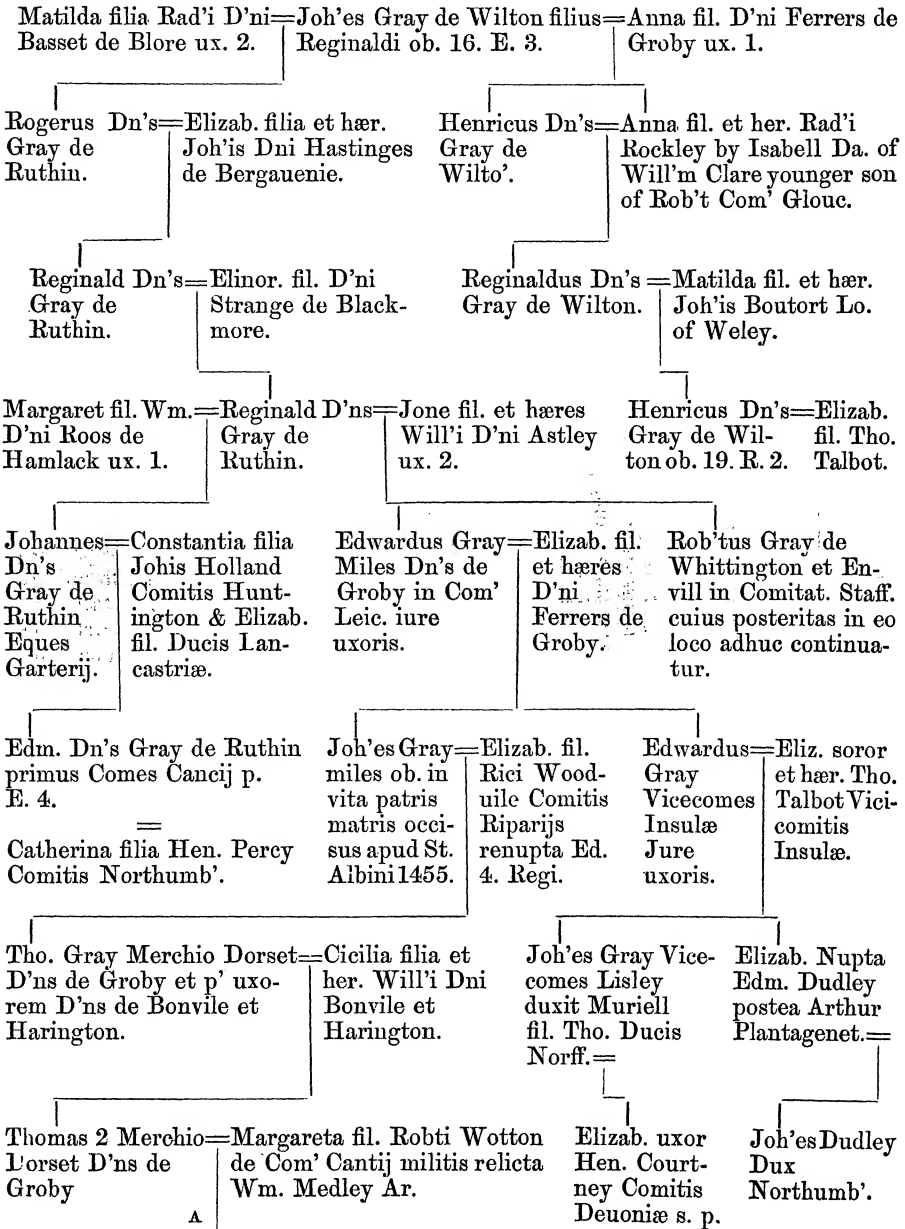

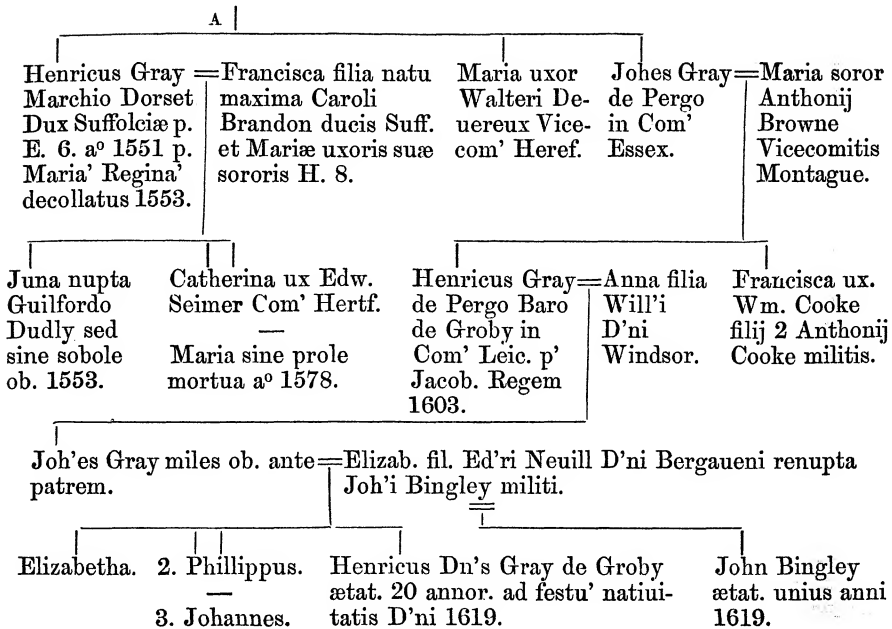

(Lacy.)

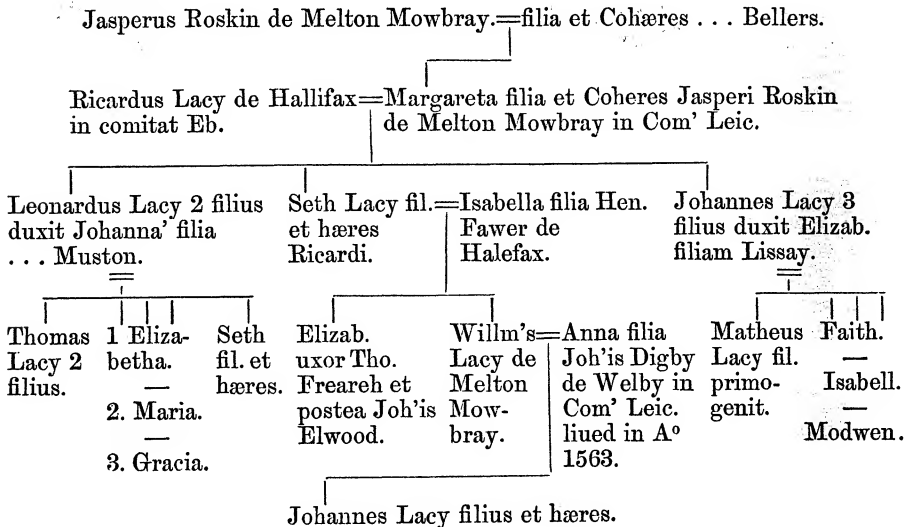

(Smalley.)

Joh'es Smalley de Bolton dedit t'ram Rob'to Smalley de Alwaston
t'ram ib'm per Cart. dat. 8. H. 4.

* Iste Rob'tus feoffavit Hen. Dominu' Grey Joh'em Sacheuerell et alios in t'ris suis de Elweston, Bolton, Ambaston, Thurleston Barow sup' Trent, Chaddesdon, Spondon Derby p'ua, Eyton, Breydsale, Smalley et Kirkhallome in Com' Derb. 10 H. 6.

SEAL. *On a bend three roses, in sinister chief a chess-rook (untinctured).*

* Rob'tus Smalley de Alwalton=Margeria. in Com. Derby cui Abbas de la vale dedit manerium de Alwalton et Margeria ux. eius A° 1. H. 4 10 Octob', et cui Rob't de Hampton dedit t'ras ib'm 10. H. 5. condidit testam't 1 Septemb' 1444. 22. H. 6. in quo legauit Collerum suum qd habuit de liber'one H. 4. æcl'ia de Alwisto' ad sustentationem suam.

Joh'es Smalley Ar. cui Ric's Sowre de Ambaston relaxauit=
ius suum in tris suis de Bolton 36. H. 6. Johanna
22 H. 6.

Rob'tus filius et hæres=
Joh'is Smalley de
Alwaston Ar. 2.
R. 3.

Rob'tus Smalley fil. iunior cui frater confirmauit ius
suum in t'ris suis de Alwalston Bulton, Thurlaston,
Baro-Chaddesdon, Spondon, Derby parua, Eyton,
Breydsale Smalley et Kirkhallom, 1. R. 3 et cui
pater Joh'is dedit eiusdem t'ras 20. E. 4.

Antonius Smalley fil. et hæres de=
Thorpe Arnold in Com' Leic. 29. H. 8. Alionora uxor eius 25. H. 8 superuixit
et Condidit testam't 20 Nouemb' A°
10. Eliz.

Georgius Smalley
de Stonesby in
Com' Leic.

Maria uxor
Sligh.

John Smalley de=
Thorpe Arnold
in Com' Leic. et
de Villa Leicest.
vendidit Thorpe
Arnold Tho.
Hartop de Bur-
ton Lazors Yeoman. 11. Eliz.

Francisca
filia
Mich'is
Purefoy de
Caldecot
in Com'
War. Ar.

... uxor Atkins
de Pickwell in
Com' Leic.

... filia et ...
hæres Croke de
Ringsted in Com'
North'ton.

Modwina
ux. Venables
renupta
Catesby.

... uxor Gulson
de Wymondham
in Com' Leic.

Antonius Smalley de Alwes=
ton in Com' Leic. et
Ringhed in Northamp.

Nicholaus=
filius 2.

3 Edwardus.
—
4. Henricus.

5. Mauritius.

Antonius 2 filius.

Georgius Smalley de Alwaston 1619.

Thomas filius Nich'i.

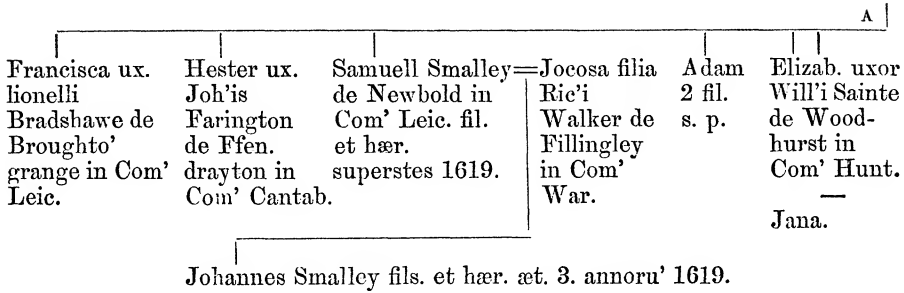

(Farnham.)

ARM. Quarterly, or and azure, in the first and second quarters a crescent counter-changed.

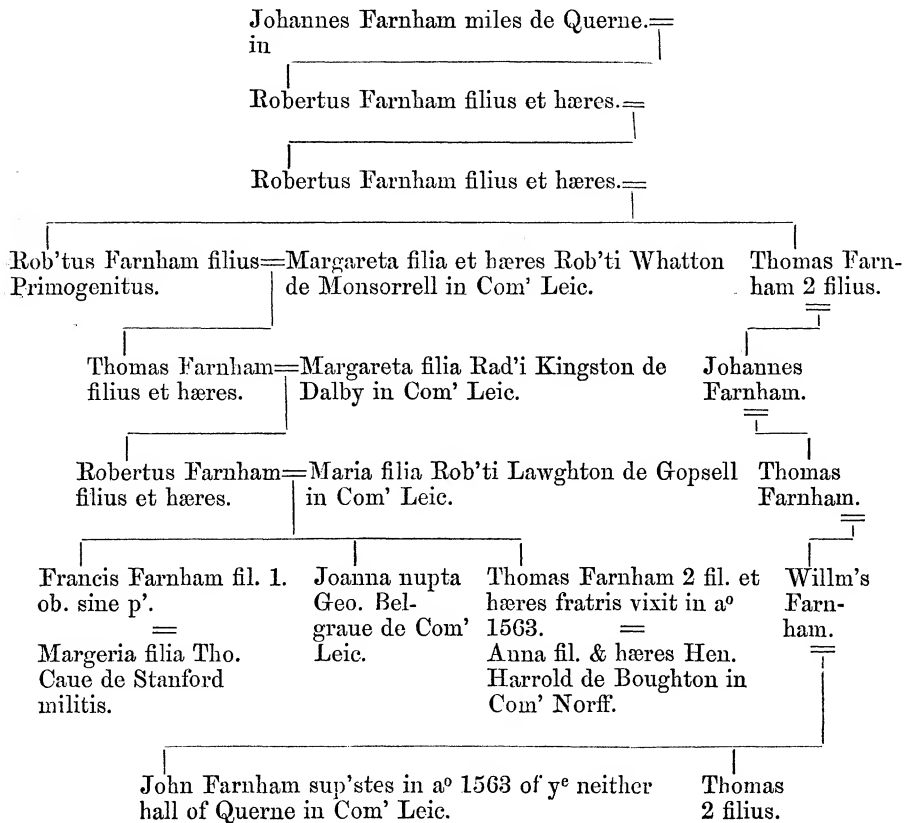

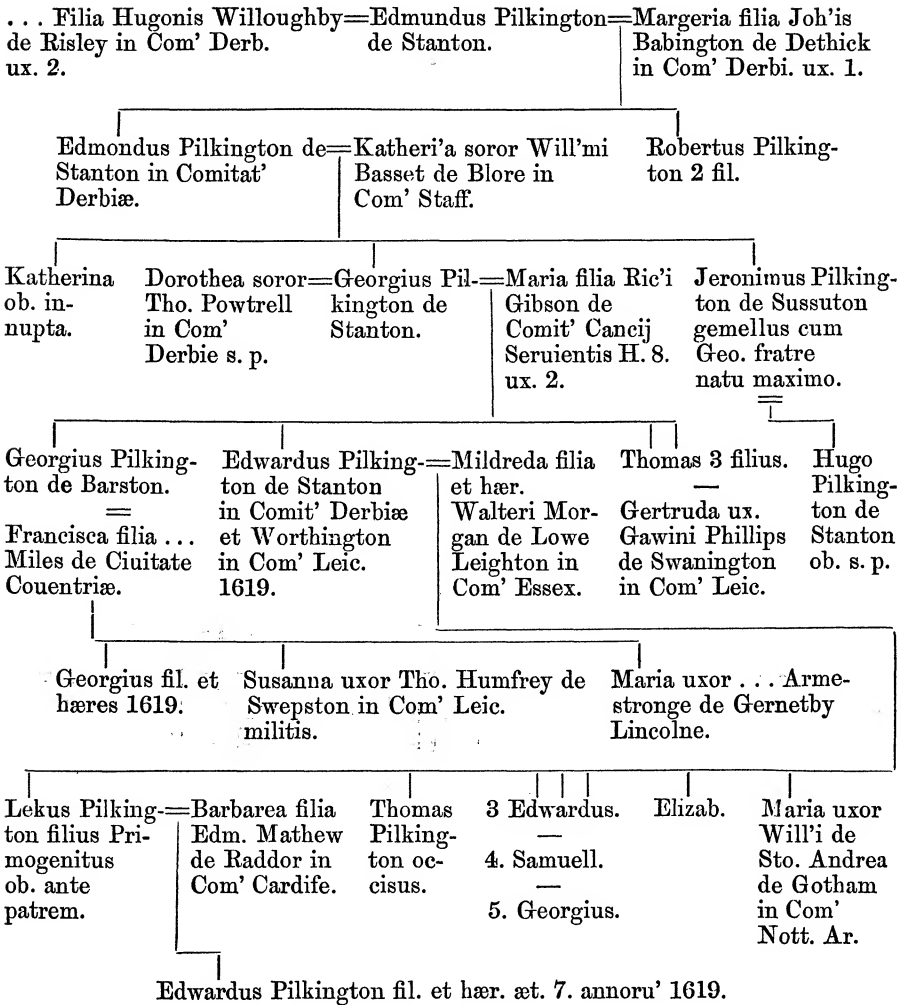
(Pilkington.)

Remember to search who was father to
Tho. Pilkington that married w^t y^e Da. &
hey. of Marmion, whose sister was mar.
to Haselwood, whether it was S^r Thomas
or not.

(Vincent.)

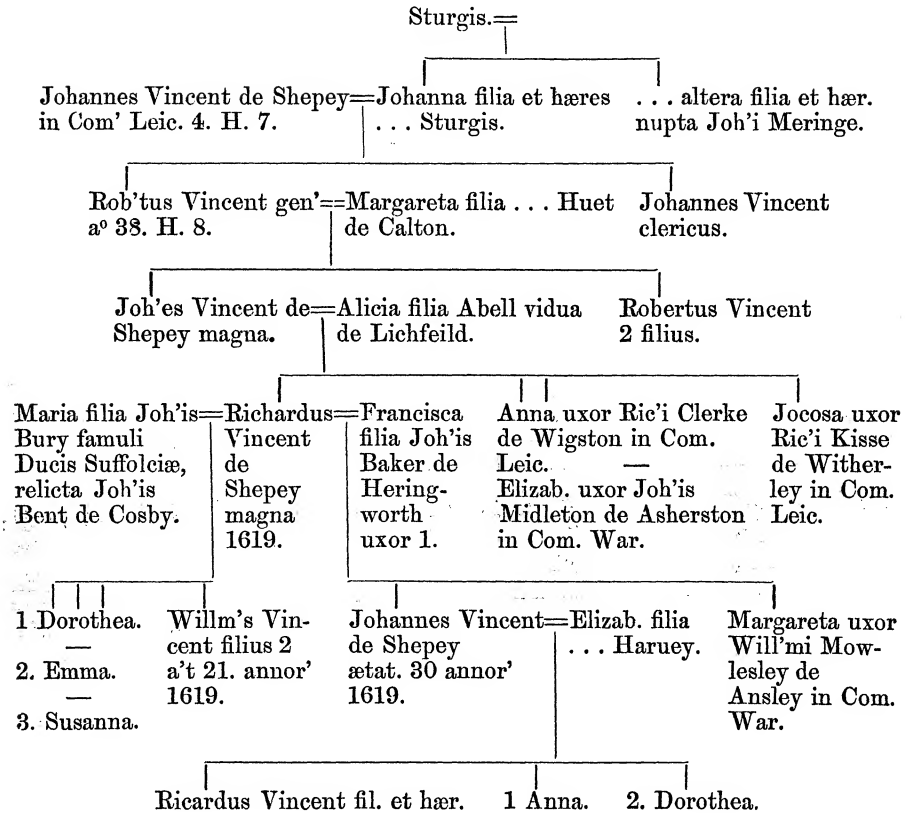

(Vincent.)

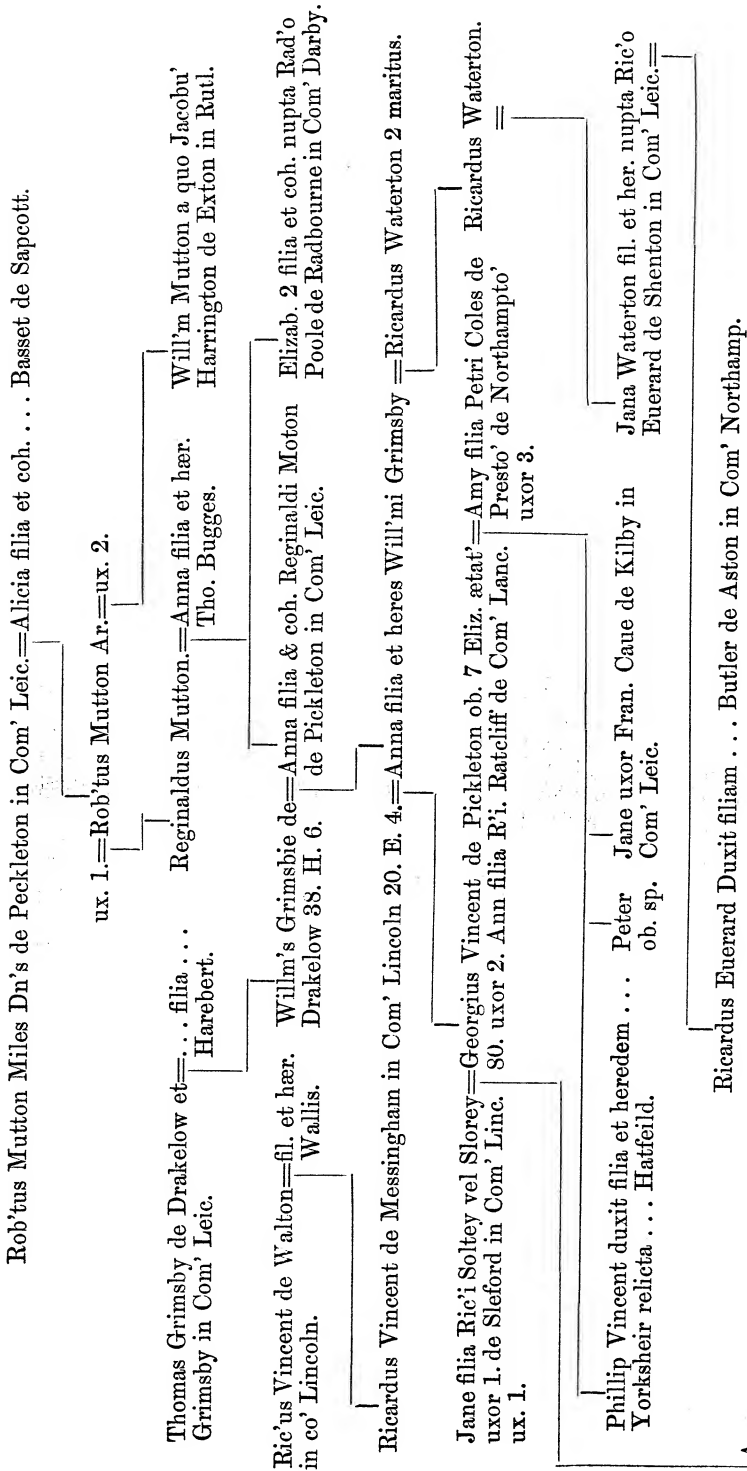

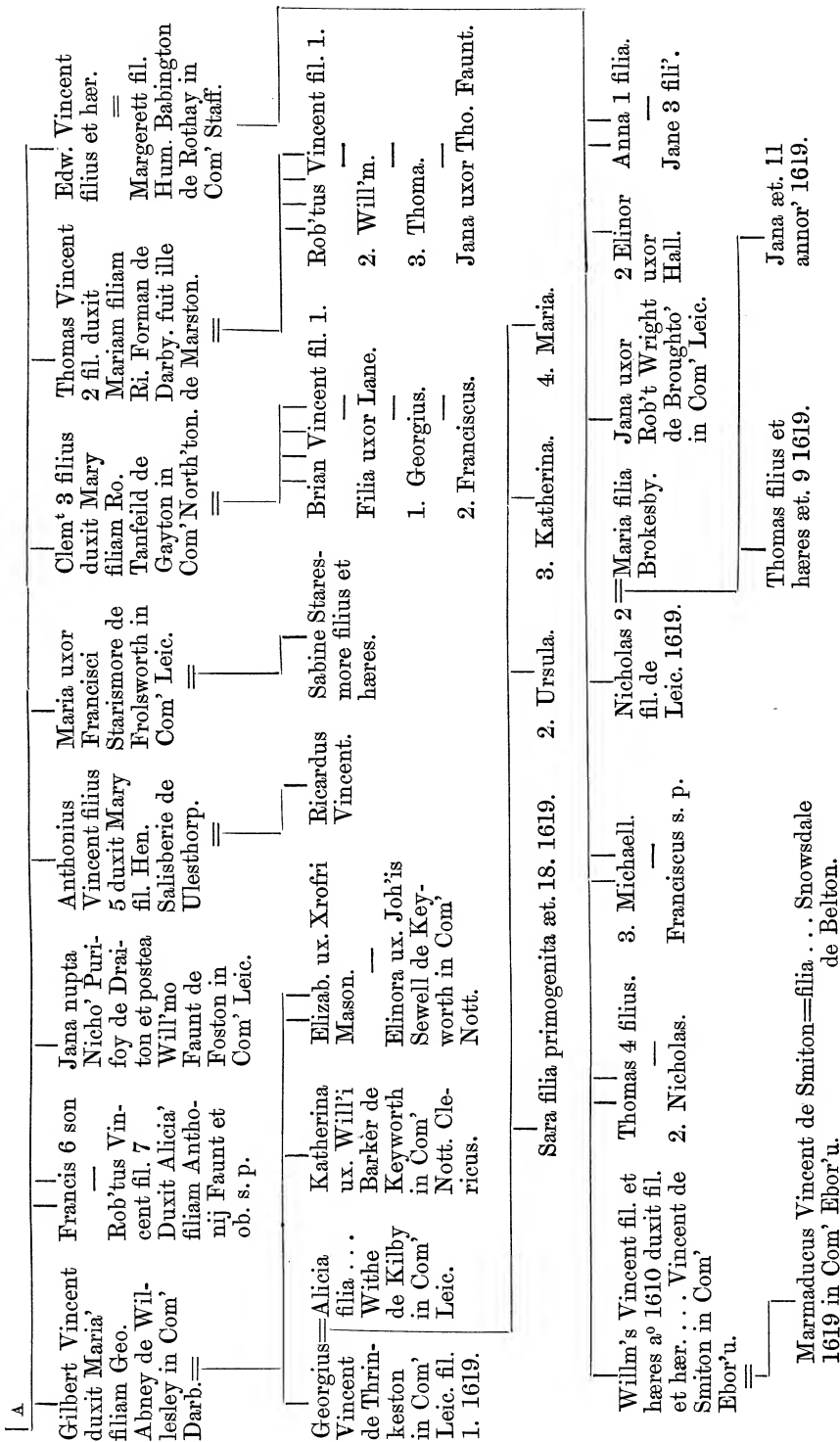

(Vincent.)

Georgius Vincent de Peckleton in Com' Leic.

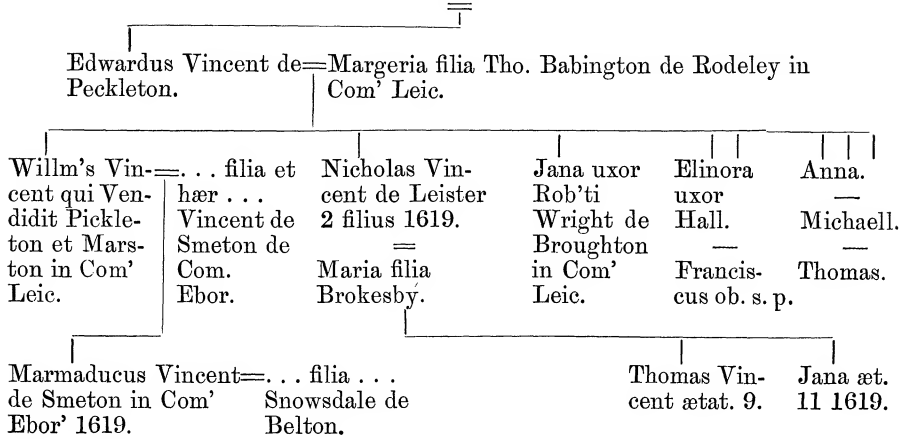
**(Shipward.)**

George Shipward de foresta de Dene in Com' Glouc.

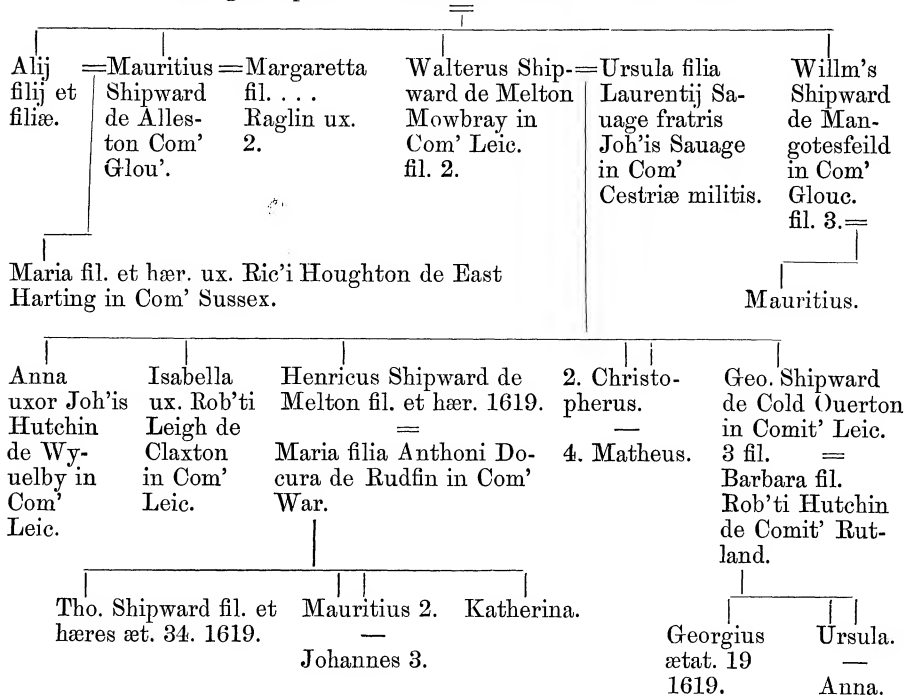

(Ward.)

ARMS. *Azure, a cross fretty between four annulets or.*

Warde de Carlton Curlew. =

Theobaldus Ward de Carlton Curlew = Anna filia . . . Cheselden vide Thomas Warde de = Felicia filia Joh'is Frisby in Com' Leic. ob. 25. H. 6. Pat. 20. H. 6. pl. 2. m. 30. Carlton Curlew. de Carlton.

Margareta uxor Joh'is Dansey. Johannes Warde de Carlton Curlew. = . . . filia Allen de Markfeild in Com' Leic.

Johannes Warde de Carlton Curlew in Com' Leic. = Elizab. filia Rob'ti Ashby de Quenby in Com' Leic. Ar.

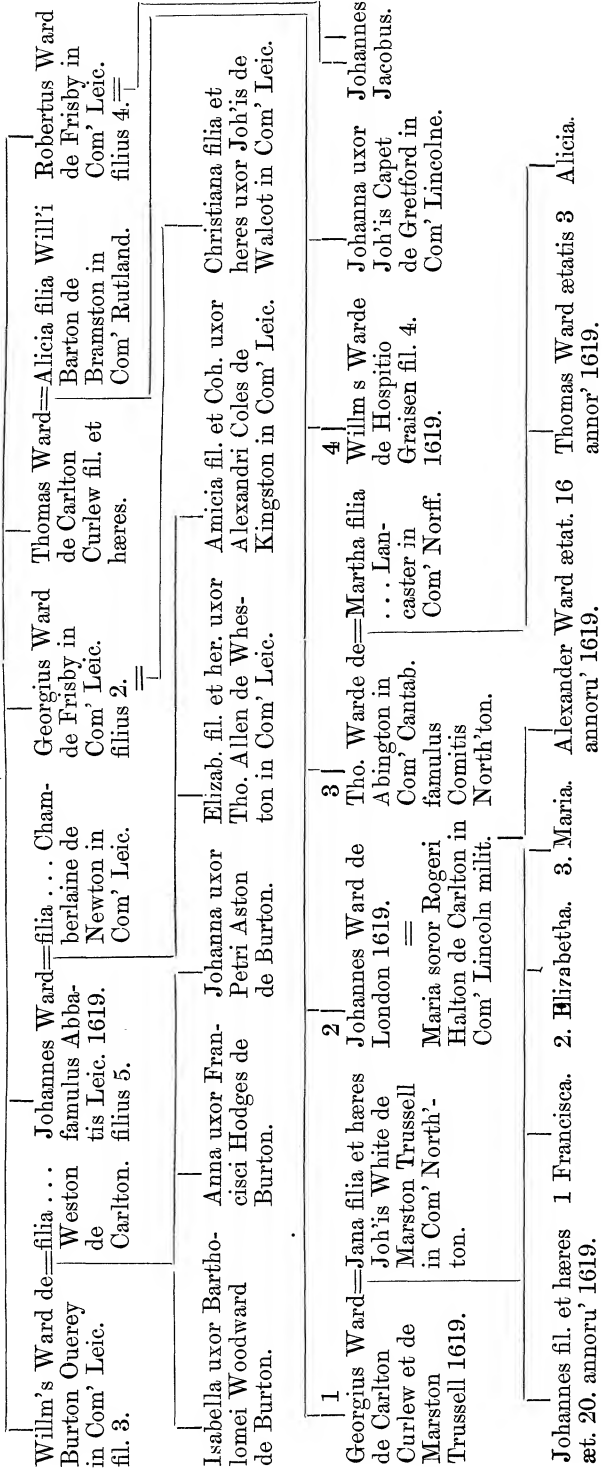

(Gore.)

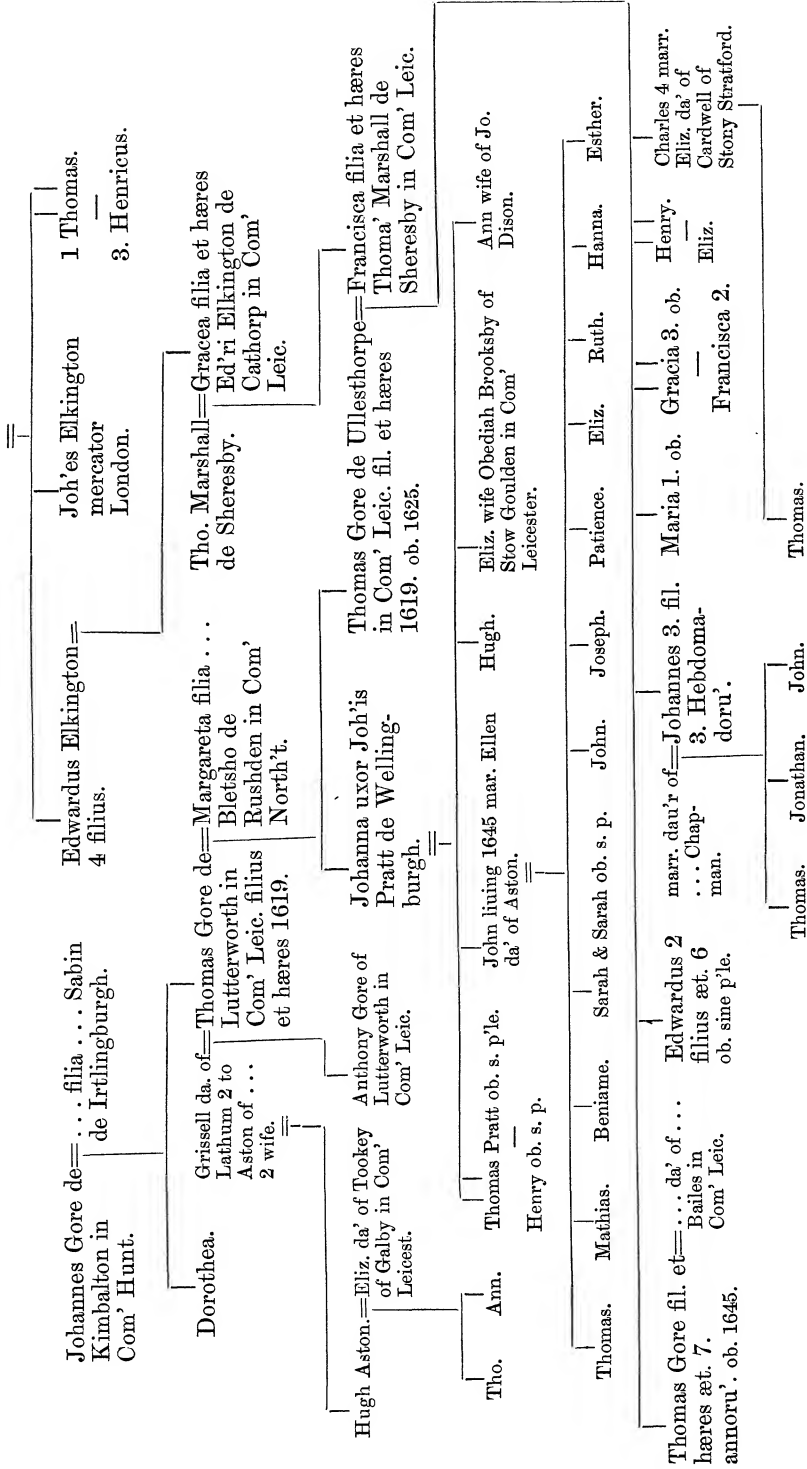

(Danvers.)

ARMS. *Quarterly*:—1. *Argent, on a bend gules three martlets or, in sinister chief a trefoil slipped (untinctured).* 2. *Argent, on a cross formée azure five fleurs-de-lis or.* 3. *Argent, a lion rampant gules.* 4. *Gules, two bars argent, in chief two stags' heads caboshed of the last.*

CREST. *A parrot vert, holding in its beak a slip of oak proper, fructed with three acorns or.*

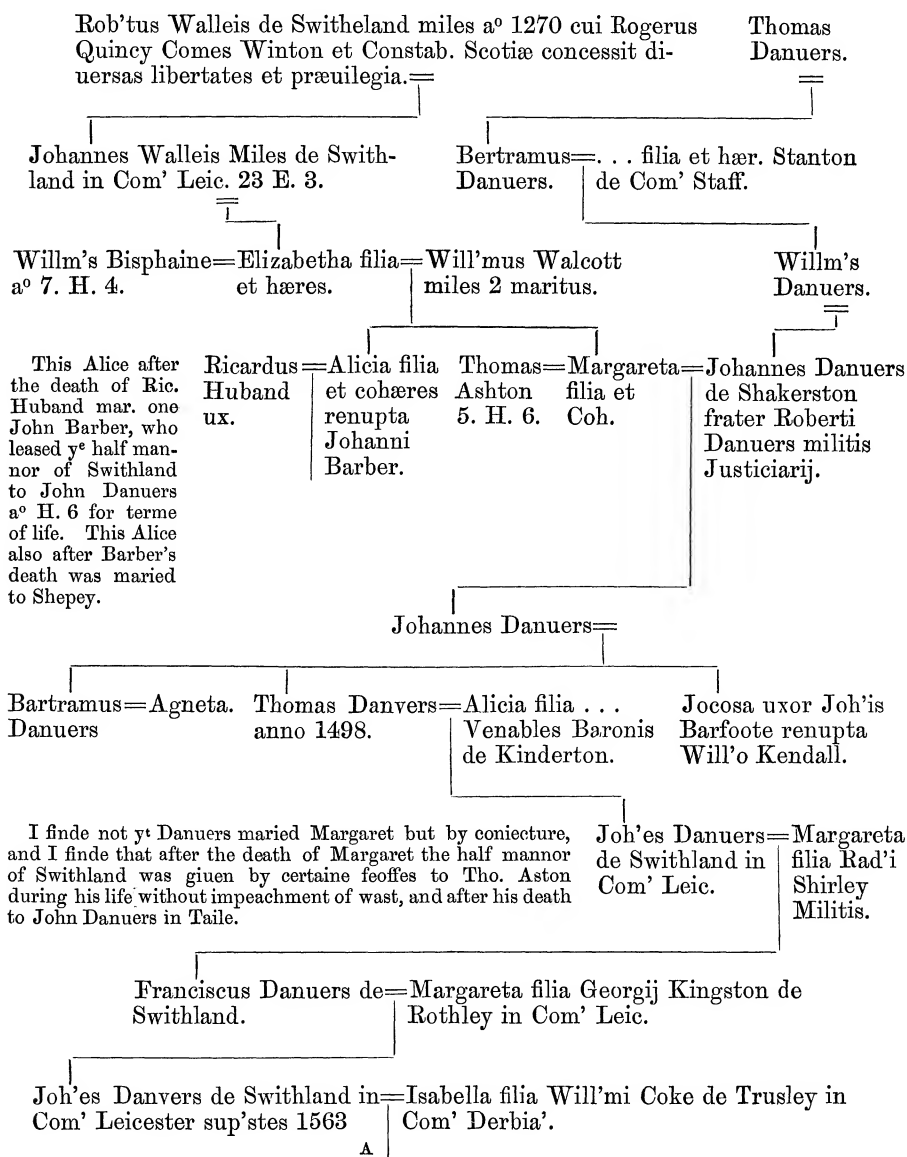

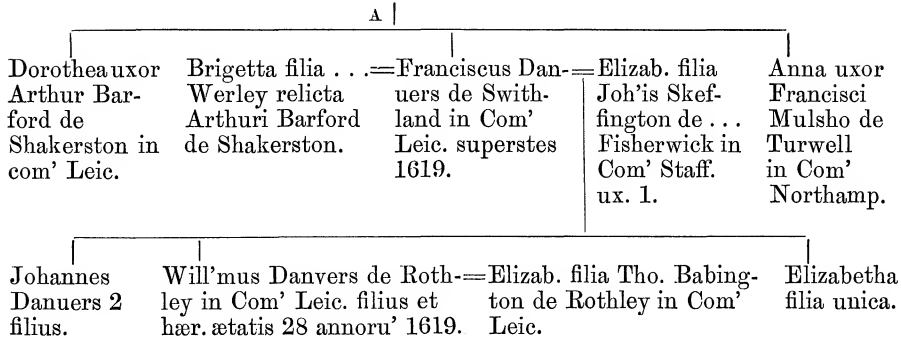

(Digby.)

ARMS. *A fleur-de-lis, in dexter chief a mullet for difference (untinctured).*

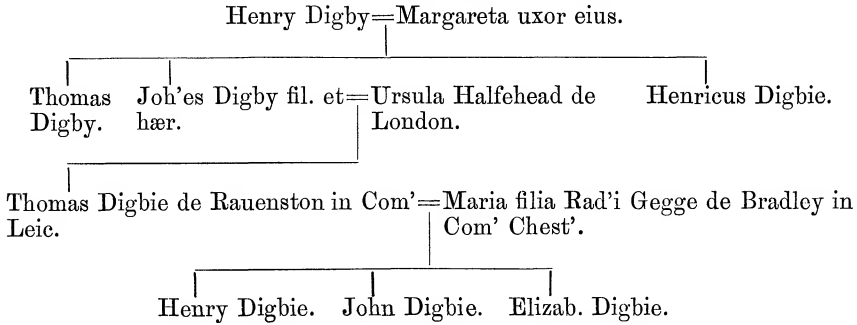

(Warde.)

ARMS. *Azure, a cross flory between four annulets or.*

Warde of Carlton Curlew in Com' Leic. ent' in the Visitac'on
of Cambridgsh. 1619.

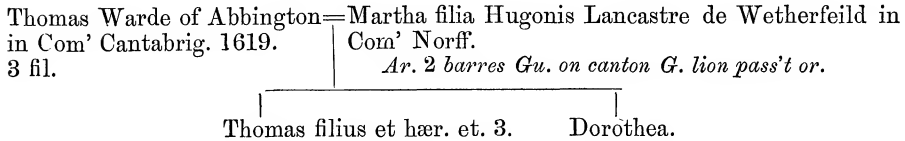

(Sherrard.)

ARMS. *Quarterly*:—1. *Argent, a chevron gules between three torteaux.* 2. *Argent, on a bend sable three trefoils or.* 3. *Ermine, a fess gules.* 4. *Argent, on a saltire sable five swans of the field.* 5. *Argent, three leopards' faces jessant-de-lis sable.* 6. *Ermine, a talbot passant sable.* 7. *Gules, on a bend or, three martlets sable.* 8. *Per fess ermine and or, a cross moline gules.*

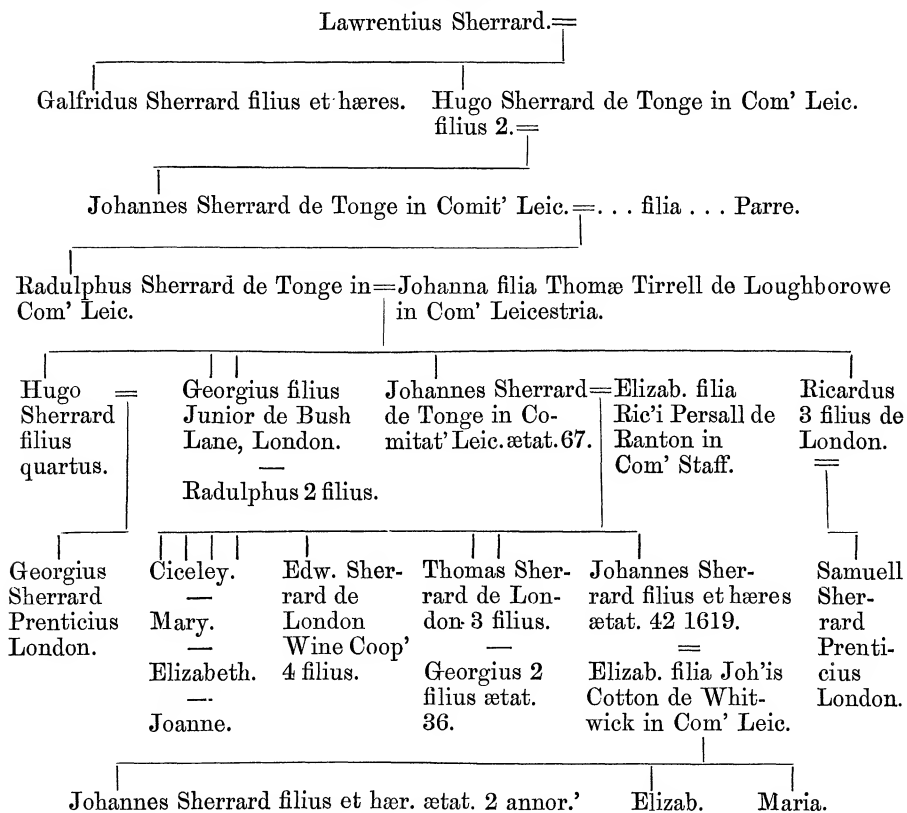
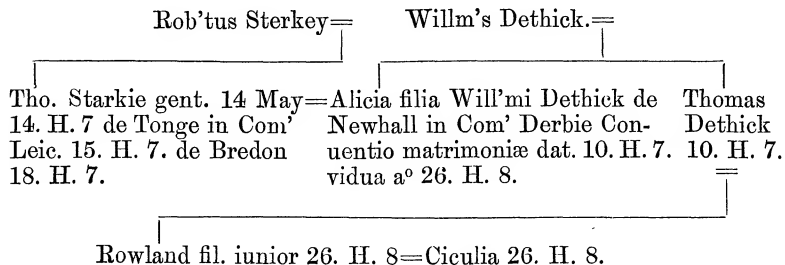
**(Dethick.)**

(Pate.)

ARMS. *Argent, three text R's sable, in chief a crescent gules for difference.*

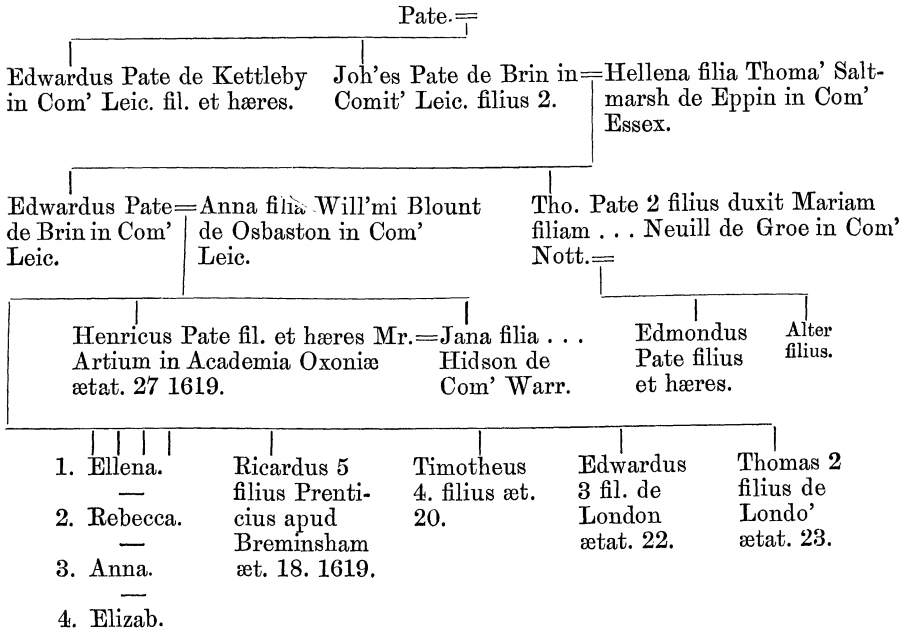

(Sharpe.)

ARMS. *Azure, a pheon argent within a bordure of the last, charged with eight torteaux, in dexter chief a crescent for difference.*

CREST. *On a ducal coronet or a peacock sitting proper, in the beak an ear of wheat of the first, charged on the breast with a crescent for difference.*

This is the Armes and Creast of Will'm Sharpe of Rolston in Com' Leic. descended of a younger brother of the Sharpes of Baydon in the county of Cumberland.

Ric. St. George Norroy
Kinge of Armes.

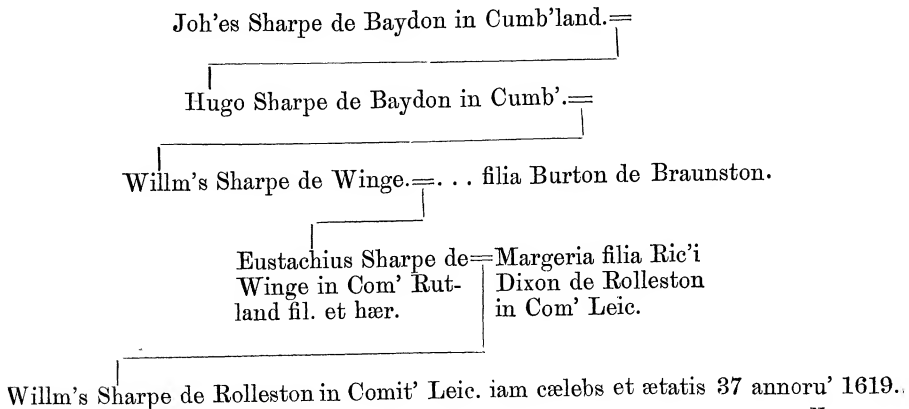

(Cooper.)

Willm's Cooper de Sapcott in Com' Leic. whose auncesto^r
cam out of Chesheire or Lankesheir.

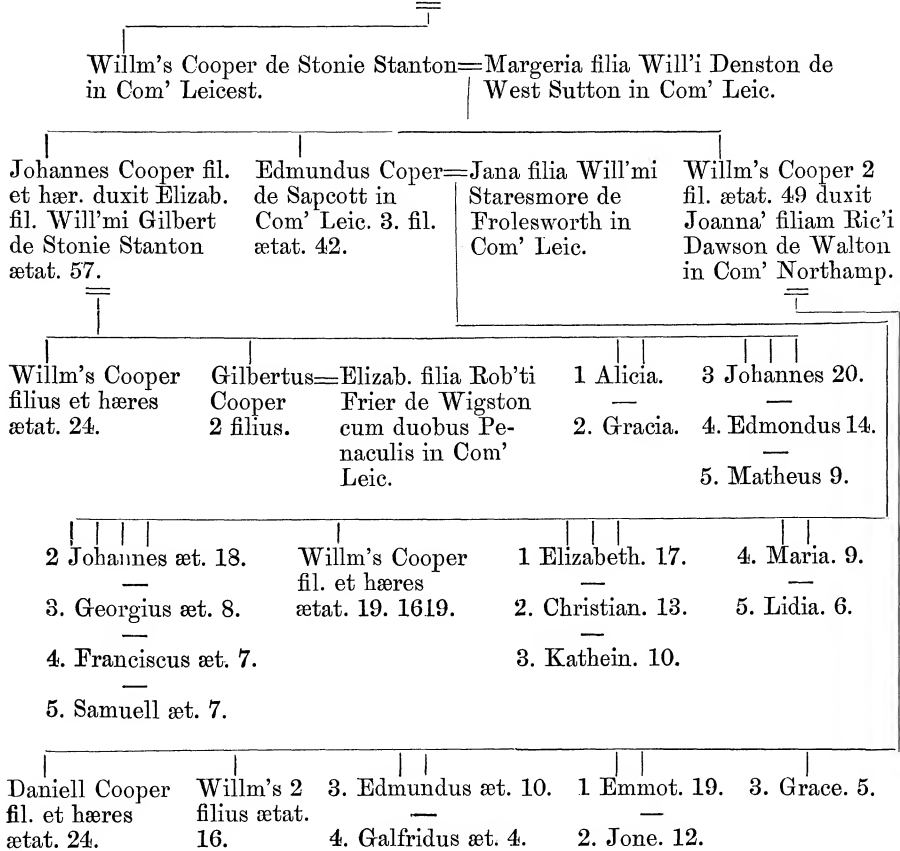
**(Kendall.)**

ARMS. *Gules, a fess chequy or and azure between three eagles displayed of the second.*

Bartholmeus Kendall de Twicresse in = . . . filia et hæ.
Comit' Leic. | . . . Shepee de

Willm's Kendall fil. et hæ. de =
Smithson in Com' Darbiæ.

A

Christopherus Kendall de Smithsby =
in Comit' Darbiæ.

B

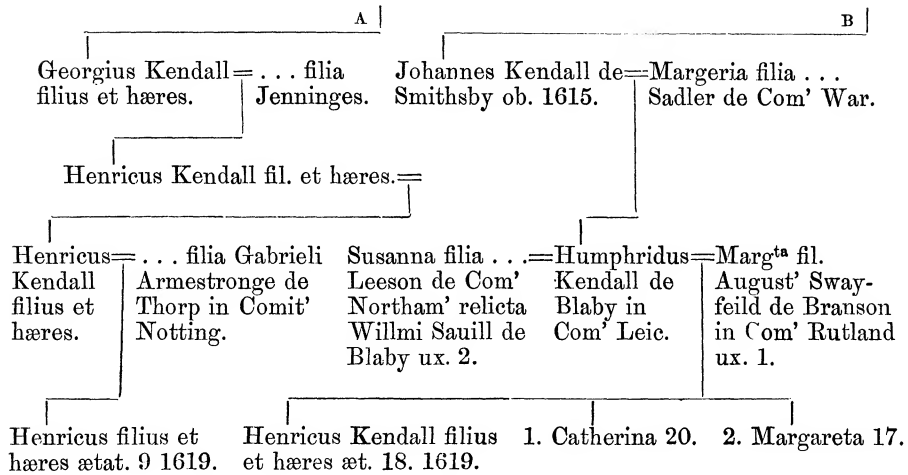

(Yarde.)

ARMS. *Quarterly:—Argent, a chevron gules between three water bougets sable; and or, on a bend sable three horse-shoes argent.*

Gilbert Yarde of Bradley = filia . . . Wadham de Merifeild quere if Yarde matched
 in Com' Deuon. in Com' Som'. wt Wadham.

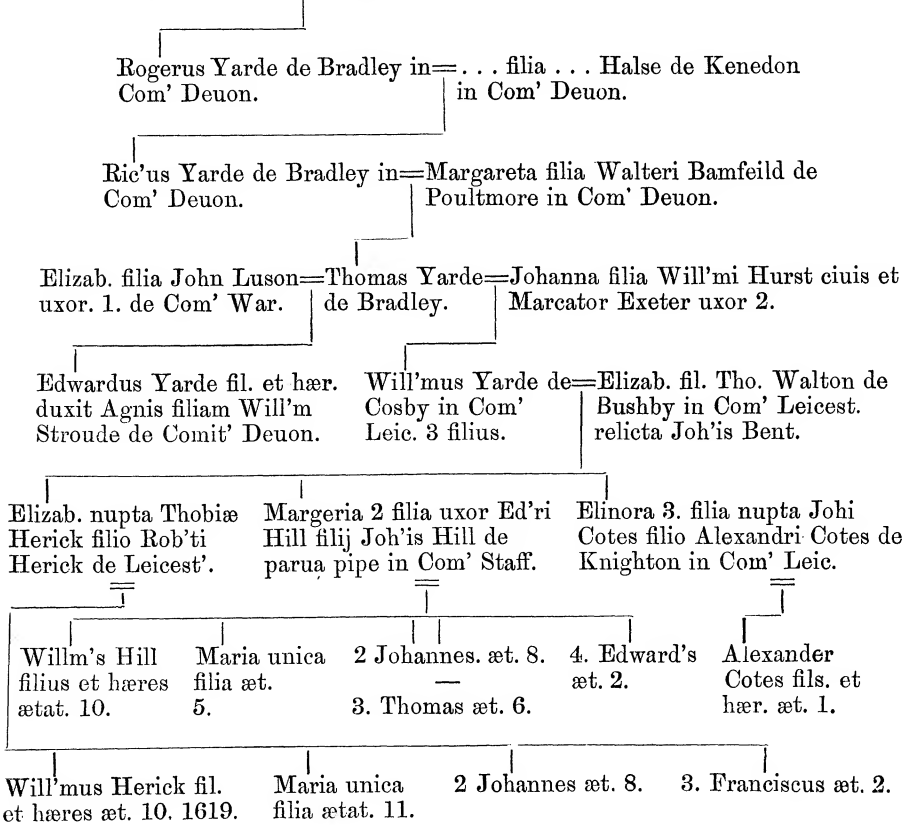

(Whiting.)

ARMS. *Per saltire azure and ermine, a leopard's face or, in chief three bezants.*

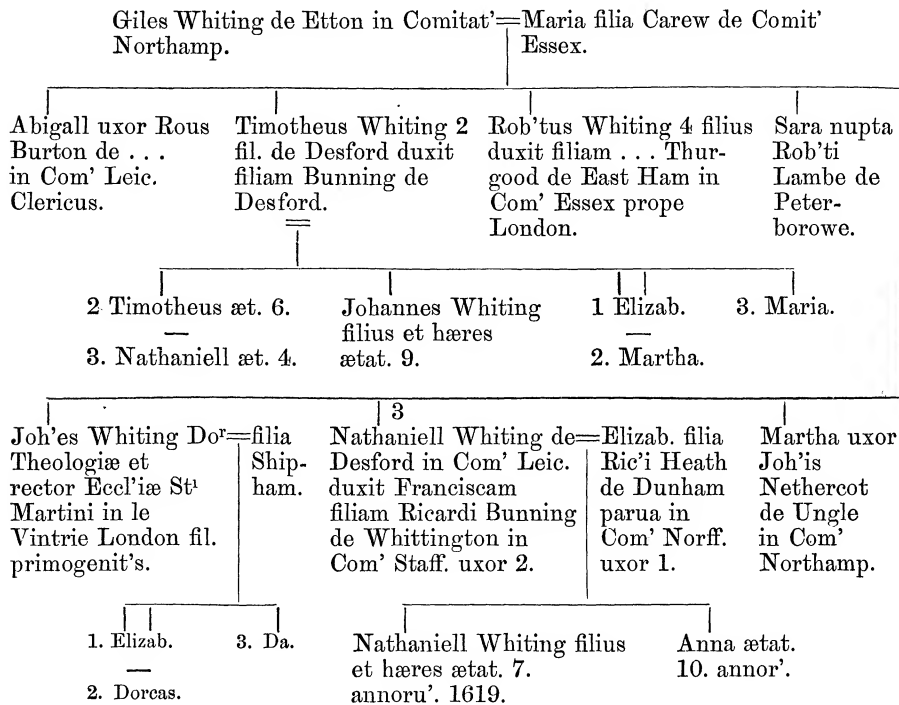
**(Roos.)**

Tho. Roos. de Ingmanthorp. h'uit 12 filios.

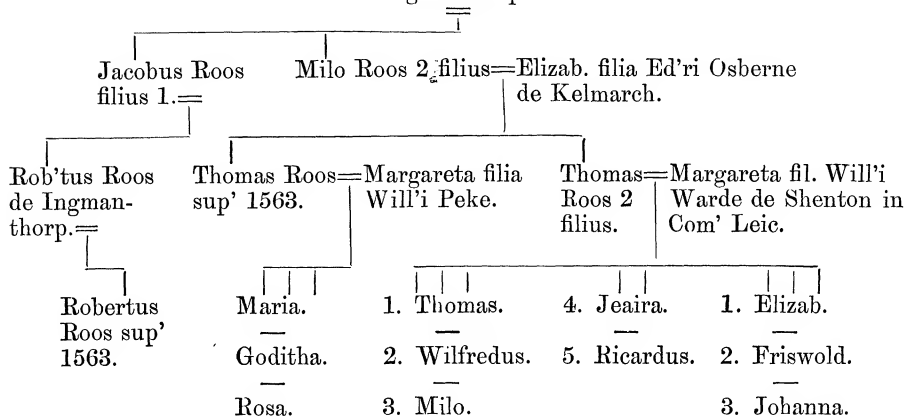

(Savill.)

ARMS. *Quarterly:—Argent, on a bend sable three owls of the field, in sinister chief a trefoil; and per pale or and azure, two piles meeting in base counter-changed, on a canton argent, a mullet gules.*

CREST. *An owl argent, membered or, charged on the breast with a trefoil for difference.*

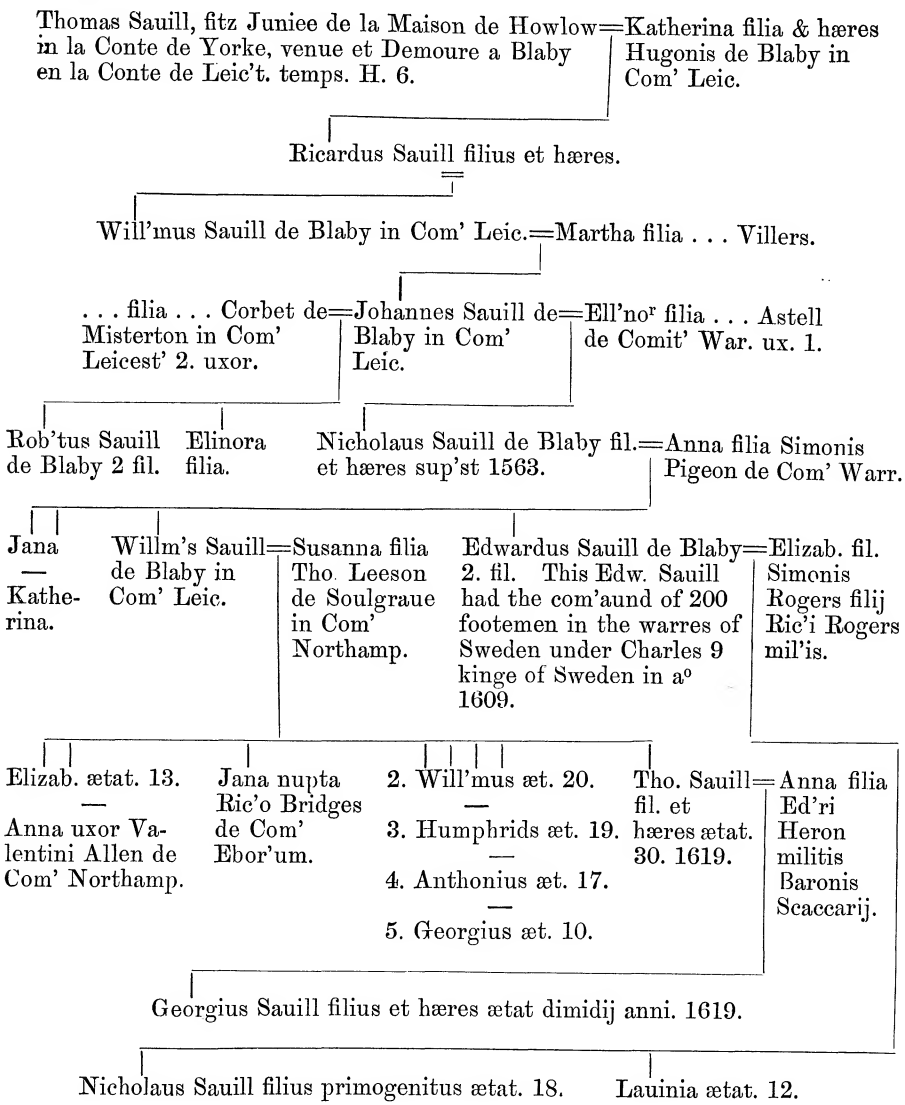

(Cotes.)

ARMS. *Argent, a fret azure, on a canton or, a lion rampant sable.*
 CREST. *A cock or, wattled gules.*

Alexander Cotes de Withington in Com' Staff.==

==Franciscus Cotes de Withington filius et hæres.

Johannes Cotes de Elson==Agneta filia Rob'ti Sterkie de Sutton supra
 in Com' Leic. 2. filius. le monte in Com' Derbyæ.

Franciscus Cotes de Withington filius et hæres.

Elizabeth uxor Thomæ Linfeild de Houghton in Com' Leic. postea ux. Fabiani Andrewes de Stretton in Com' Leic.

Job'es Cotes==Anna fil. de Elson in Comit' Leic. 3. filius ætat. 46. 1619.

Rogerus Cotes filius Duxit Hellenam filiam Rob'ti Gillett de Leicest.==

Alexander Cotes de Withington filius et hæres.

Thomas Cotes de Belgrang in Com' Derbyæ fil. 2. ætat. 48.

Rob'tus Cotes fil. et hæres ætat. 4. Annor'. 1619.

Anna unica Cotes 2. fil. filia etat. 5. ætat. 8.

Rob'tus Cotes fil. et hæres. æt. 10.

Johannes Cotes fil. et hæres æt. 26. 1619.

Ellena filia Will'mi Yarde de Cosbie in Com' Leic. who came out of Deuonsh.

Thomas Cotes 2 fil. ætat. 13. Ricardus Cotes fil. et hæres. ætat. 23.

Alexander fil. et hæres ætat. dimidiu' anni 1619.

(Turner.)

ARMS. *Quarterly*:—*Argent, a fer de moline sable; and ermine, a chevron azure between three garbs or; impaling or, a fess indented gules, in chief three boars' heads sable.*

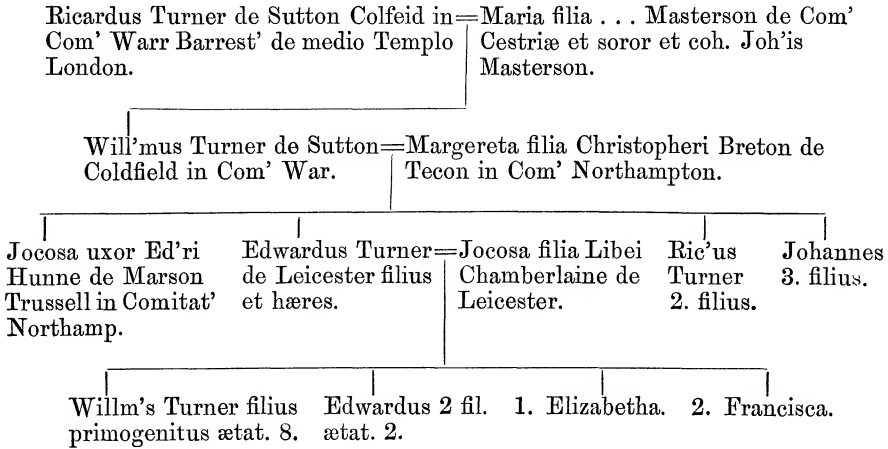

(Belgraue.)

ARMS. *Quarterly*:—*1. Gules, a chevron ermine between three mascles argent. 2. Argent, three pairs of bellows sable. 3. Sable, three escallops argent. 4. Ermine, three mascles conjoined in fess sable.*

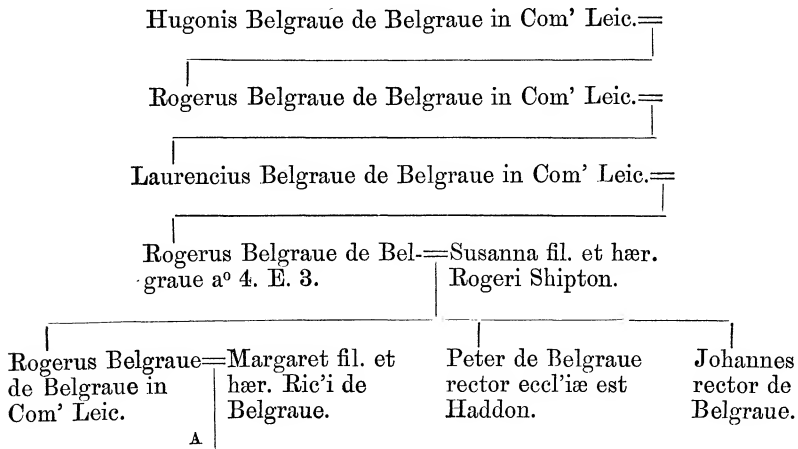

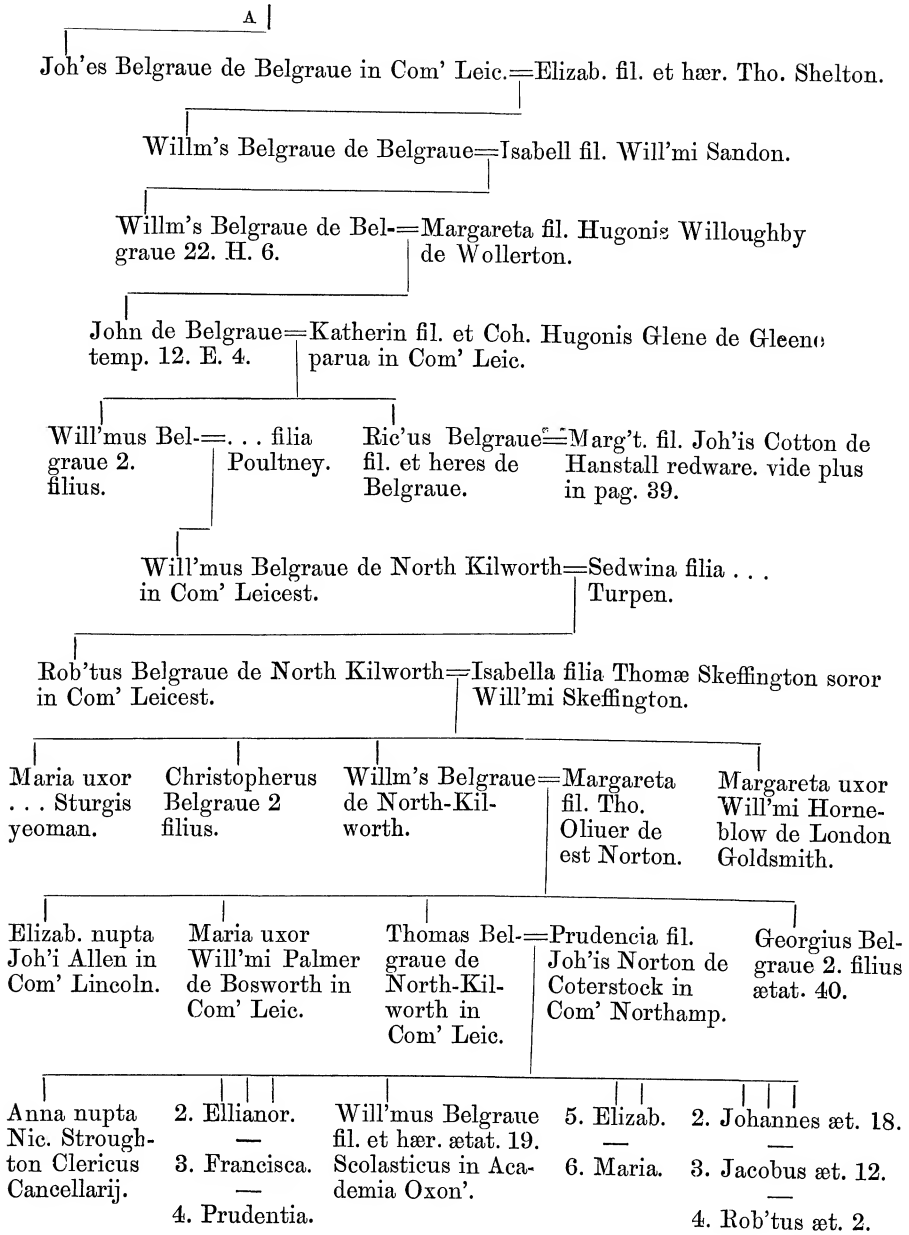

(Wigley.)

ARMS. *Paly of six embattled argent and sable.*

CREST. *Out of flames proper a tiger's head argent, maned sable, gorged with a collar embattled gules.*

Henricus Wigley de Workesworth in Com' Derbiæ.

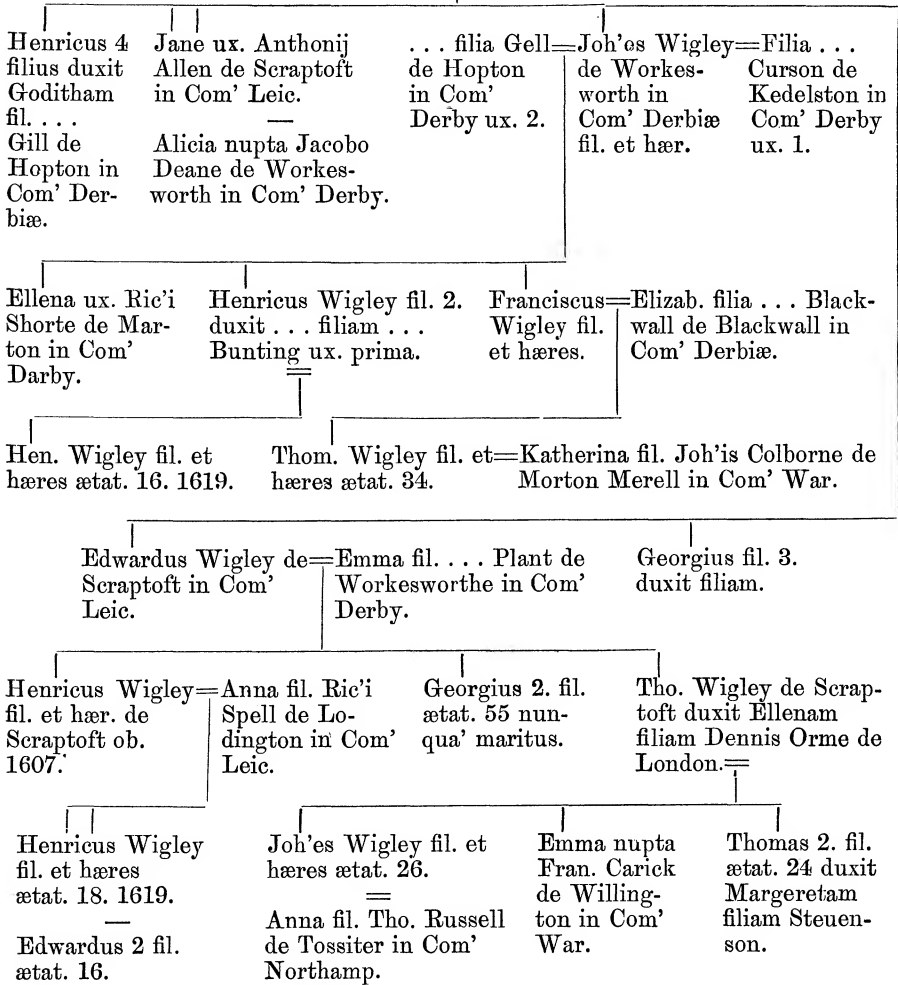

(Dawes.)

ARMS. *Argent, on a bend azure cotised gules between six battle-axes sable, three swans or.*

CREST. *A demi-battle-axe erect, staff or, and blade argent, on the point a dragon volant with tail nowed sable, bezantée.*

Johannes Dawes de Stapleton in Com' Leicest.

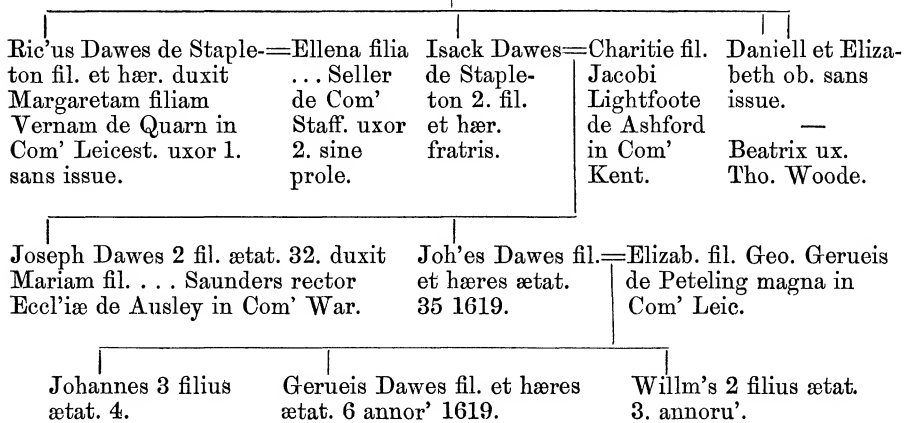
**(Whitaph.)**

Willm's Whitaph de Reresby in Com' Leic. Bacalarius =
Theologiæ et rector Eccl'ia de Reresby obiit 1617. | Catiell de Rerisby.

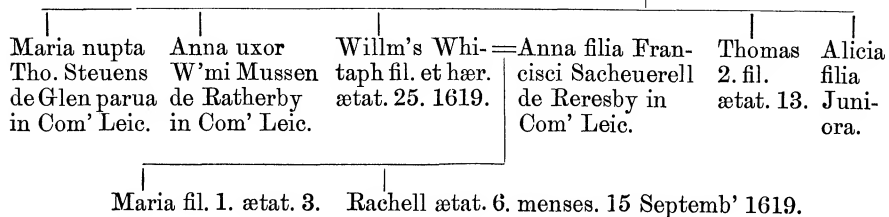

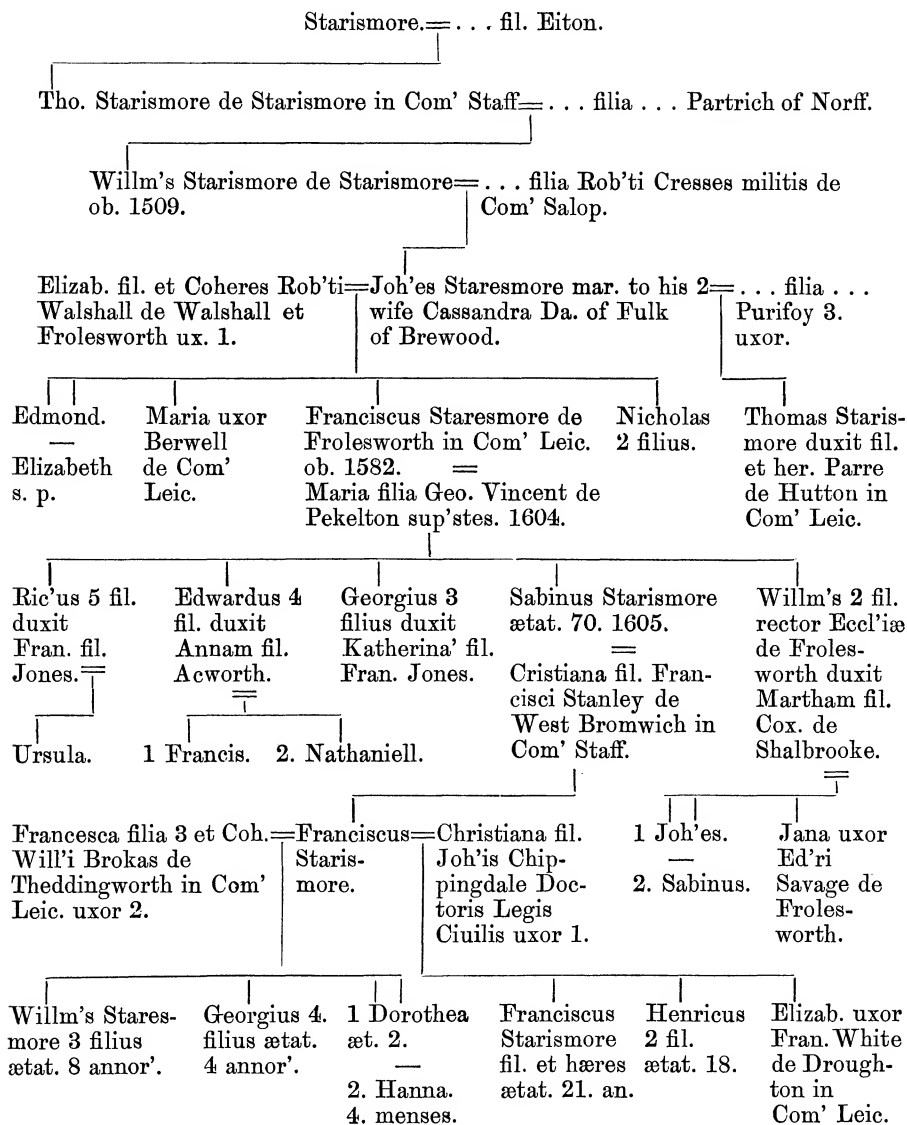
(Staresmore.)

(Needham.)

ARMS. *Argent, on a bend engrailed azure between two bucks' heads caboshed sable, a crescent for difference.*

CREST. *On a mount vert a buck lodged sable, attired or, charged with a crescent for difference.*

... uxor Prima. = Thos. Needham de Alexton in Comit' = filia Parker uxor 2.
Leic.

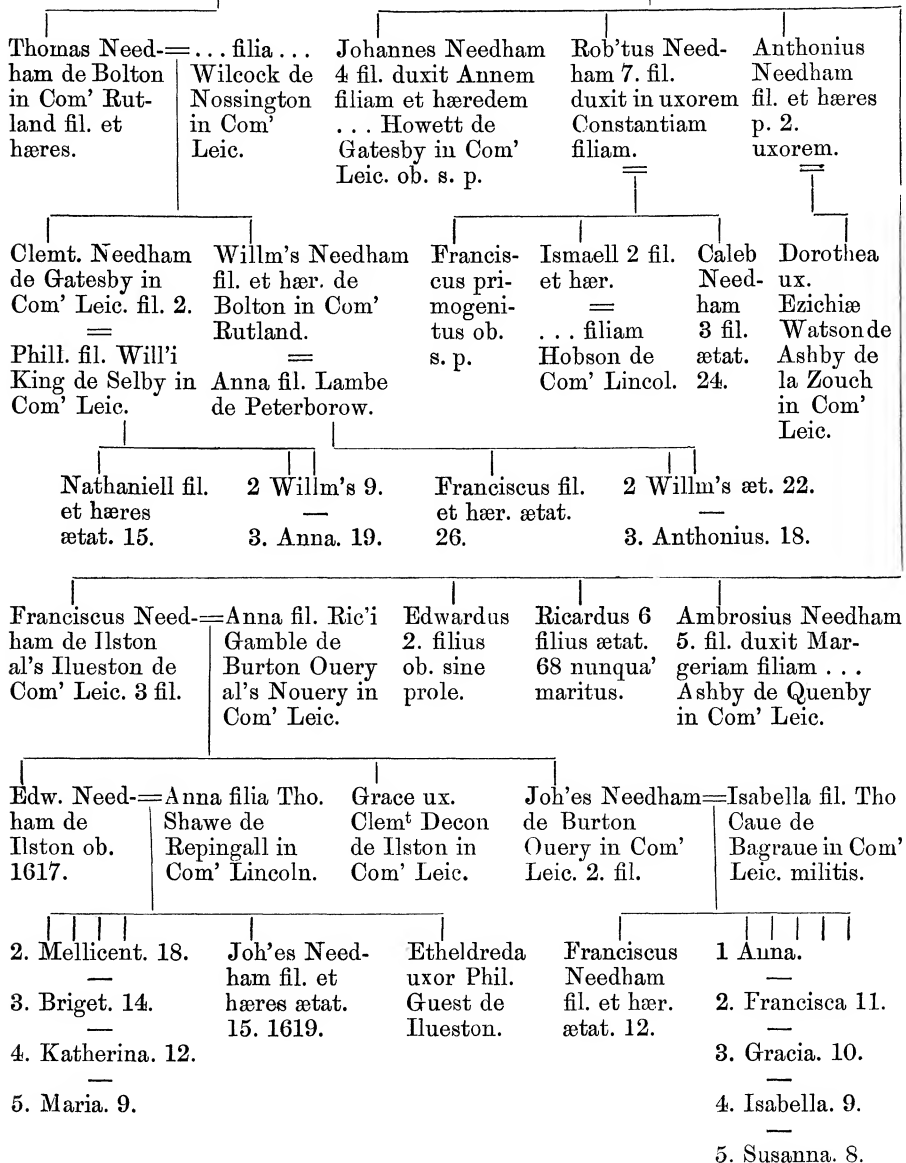

Marstone.

ARMS. *Sable, a fess indented ermine between three fleurs-de-lis argent.*

Will'mus Marston de Slawston in Com' Leister.=

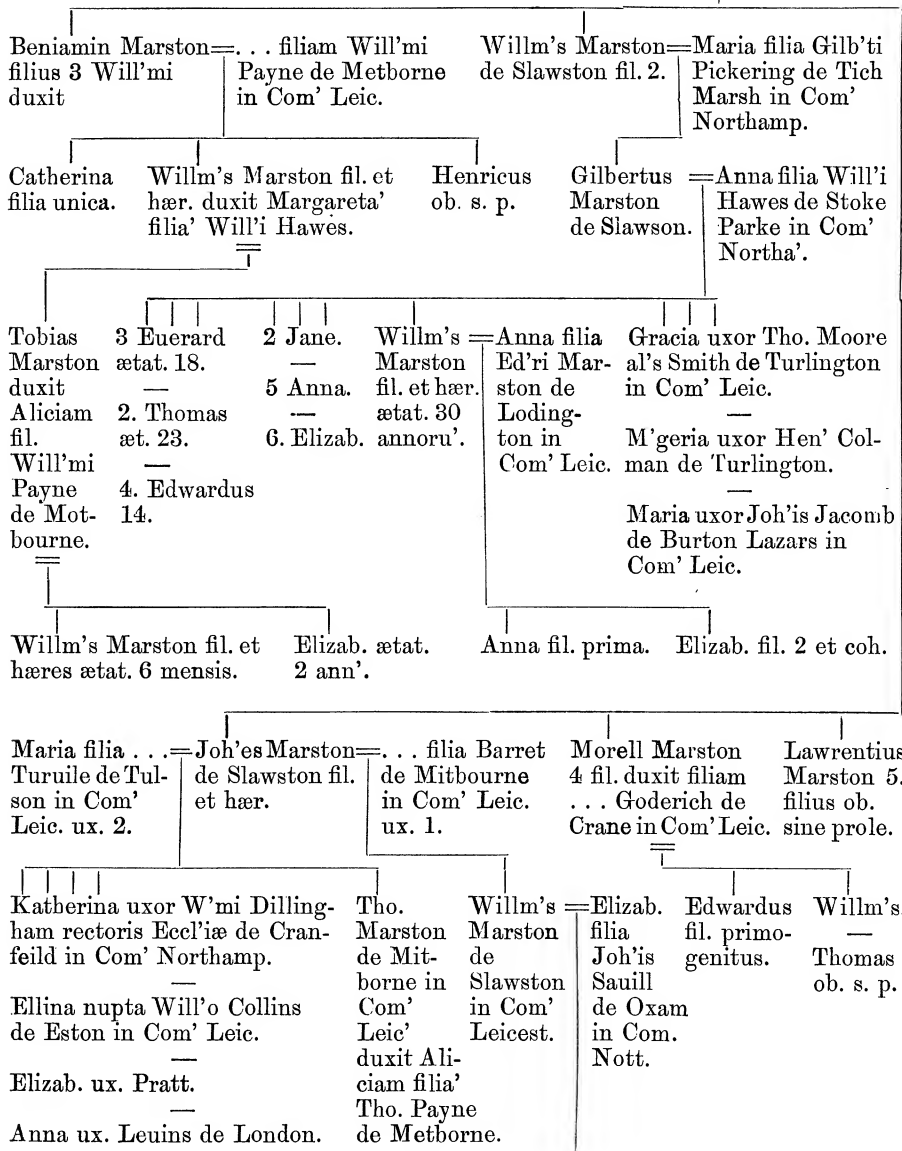

A

B

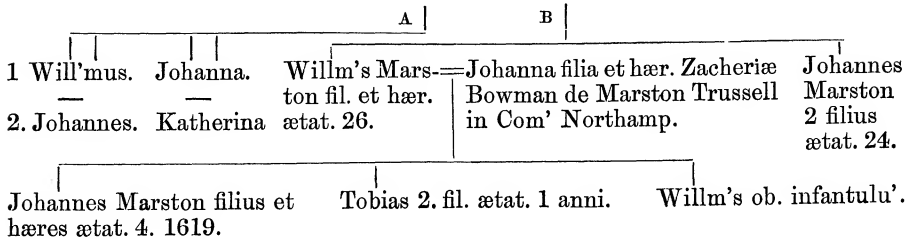

(Lawrence.)

... Lawrence de longe Whatton in Com' Leic. =

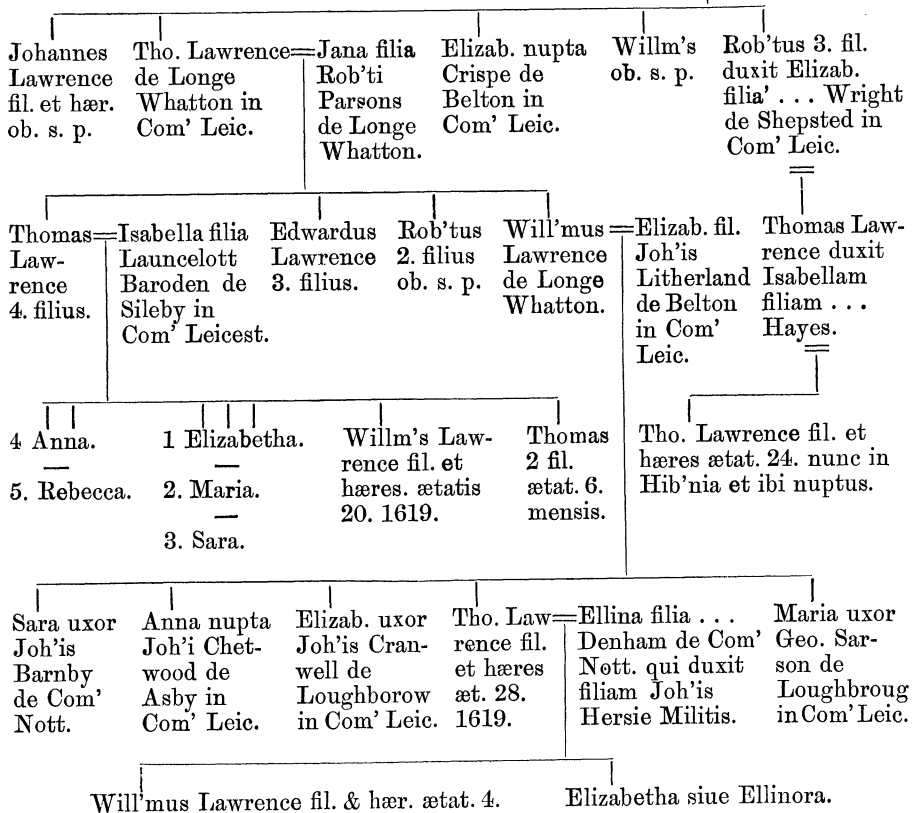

Marshall.

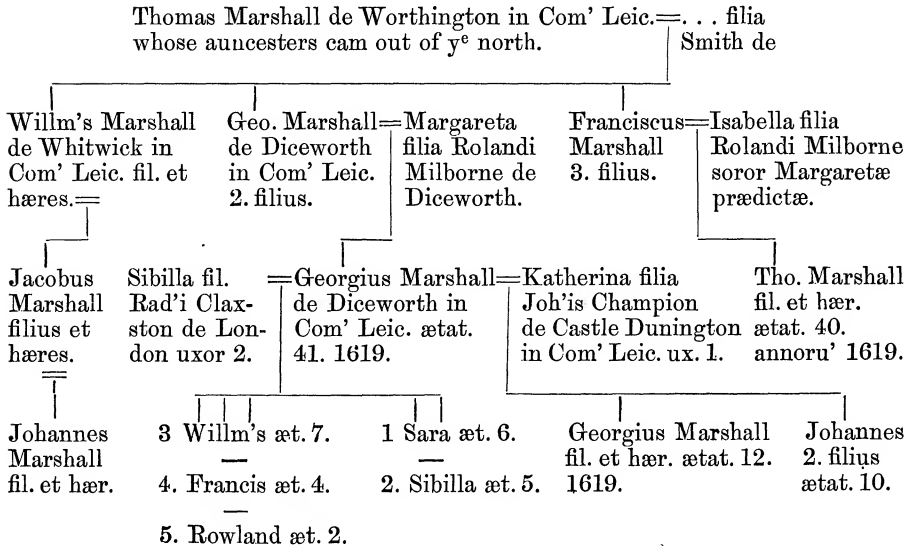

(Peper.)

ARMS. *Quarterly*:—1. *Gules, on a chevron argent, between three demi-lions rampant, couped or, as many sickles sable, in chief an annulet for difference.* 2. *Or, on a fess sable three water bougets argent.* 3. *Argent, a chevron between three garbs gules, in chief a martlet for difference.*

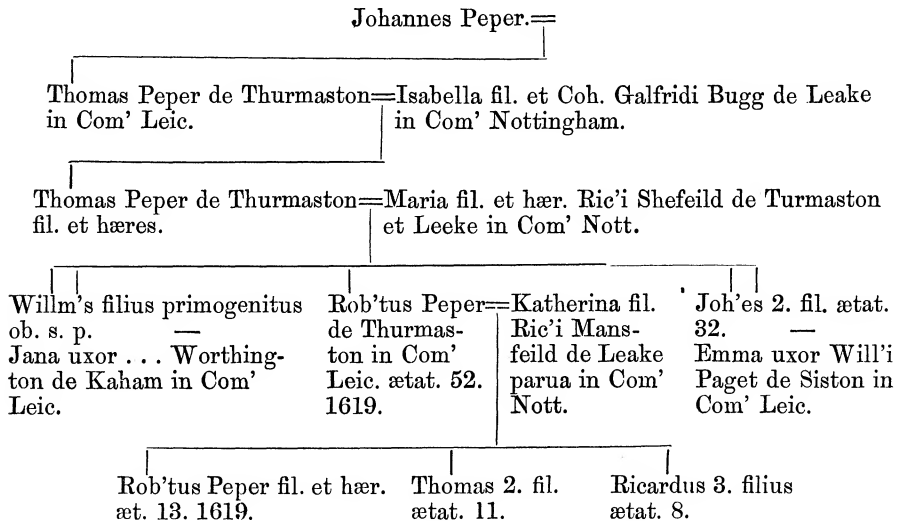

(Ruding.)

ARMS. *Quarterly*:—1. *Argent, on a bend between two lions rampant sable, a dragon extended of the field, a crescent for difference.* 2. *Argent, on two bars sable three plates.* 3. *Sable, three fleurs-de-lis between seven cross crosslets fitchée argent, three, three, one, a canton ermine.*

CREST. *A dragon's head coupéd, collared, and chained, in the mouth a lion's gamb, erased (untinctured).*

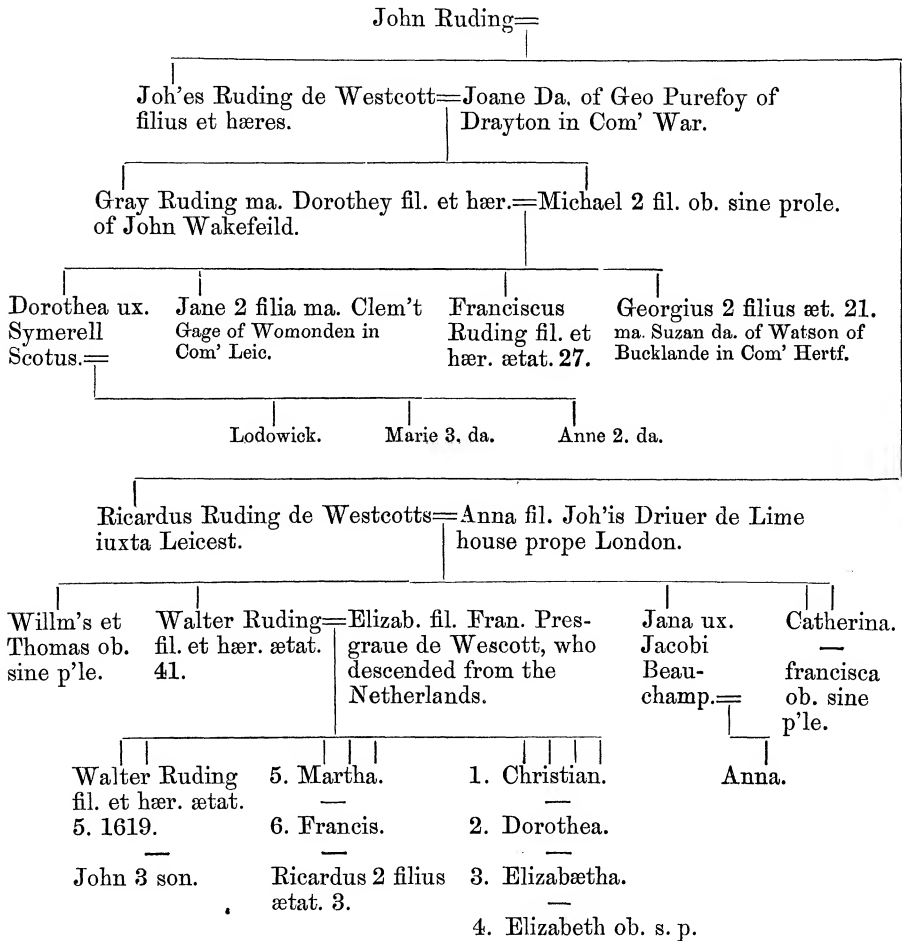

(Alsop.)

ARMS. *Sable, on a chevron between three doves or, a mullet for difference.*

Humphredus Alsop de Alsop in Com' Derbyæ
Steward to Edward last Duke of Buck.

Willm's Alsop de Alsop = Isabella filia Joh'is Warner de Marke-
in Com' Derbyæ. feild in Com' Leic.

Carolus Alsop de = Maria fil. Will'i Markefeild in Cooper de Thur- Com' Leic. 3. fil. Leic.	Joh'es Alsop rector Eccl'ie de Beeby in Com' Leic. 2. fil.	Willm's Alsop 4. filius ob. s. p.
---	--	---

Jana 2. filia. — Maria nupta Ric'o Spencer de Onlippe in Com' Leic.	Humphredus = Katherina Alsop fil. et fil. . . . hær. ætat. Allen de 30. Com' Rut- land.	2. Willm's ætat. 28. — 3. Georgius æt. 25. — 4. Johannes æt. 21.	Nicholas 5 filius ætat. 17.
--	---	--	-----------------------------------

Willm's Alsop fil. et hæres.
ætat. 3. 1619.

Maria 2. septimano' 15.
Septemb' 1619.

Dorothea fil. = Humphredus Alsop = Elizaab. fil. Welsh Moleneux fil. et hæres de who married the de Carlton Putterley Hall in Da. of Judg South- in Com' cott uxor. 1. Nott. ux. 2. Com' Darbiæ.	Georgius Alsop 5 filius de Leicester duxit Anna' fil. Geo. Agar de Newborow in Com' Staff.
--	--

. . . fil. p' uxore' 2.

Humphredus Alsop fil. et
hær. ætat. 15. 1619.

Maria ætat. 19.

(Pochin.)

ARMS. *Quarterly* :—1. *Argent, a chevron gules between three horse-shoes sable.* 2. *Or, on two bars gules three water bougets argent, in chief an annulet for difference.* 3. *Argent, on a cross azure five mullets or.* 4. *Blank.* 5. *Azure, three fleurs-de-lis argent within a bordure engrailed or.* 6. *Gules, a fess indented between six billets or.*

CREST. *A harpy (untinctured).*

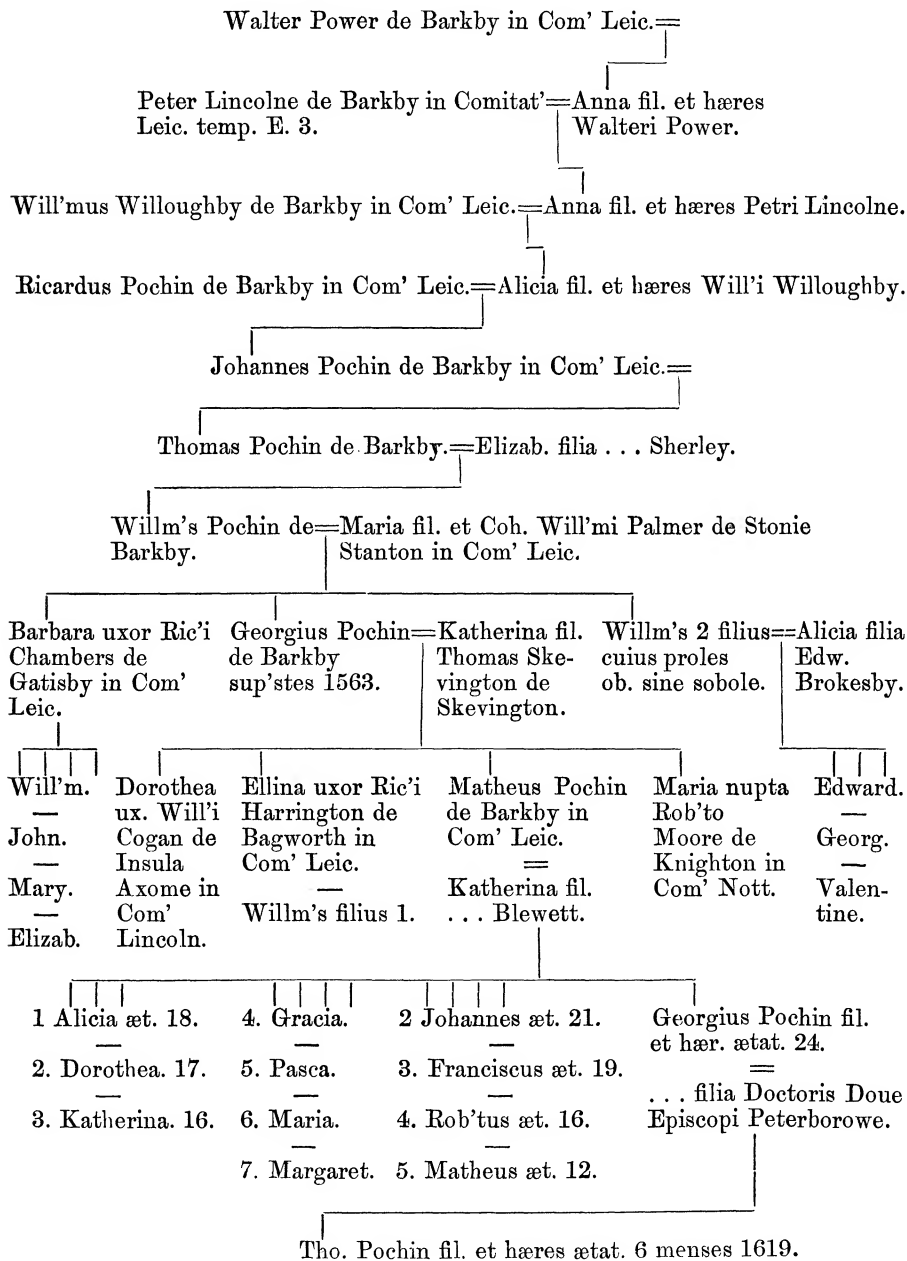

(Barret.)

ARMS. *Per pale argent and gules, a fess counterchanged.*

Ric'us Barret de Wimsole in Com' Leic. qui vienne del Contie d'Essex.

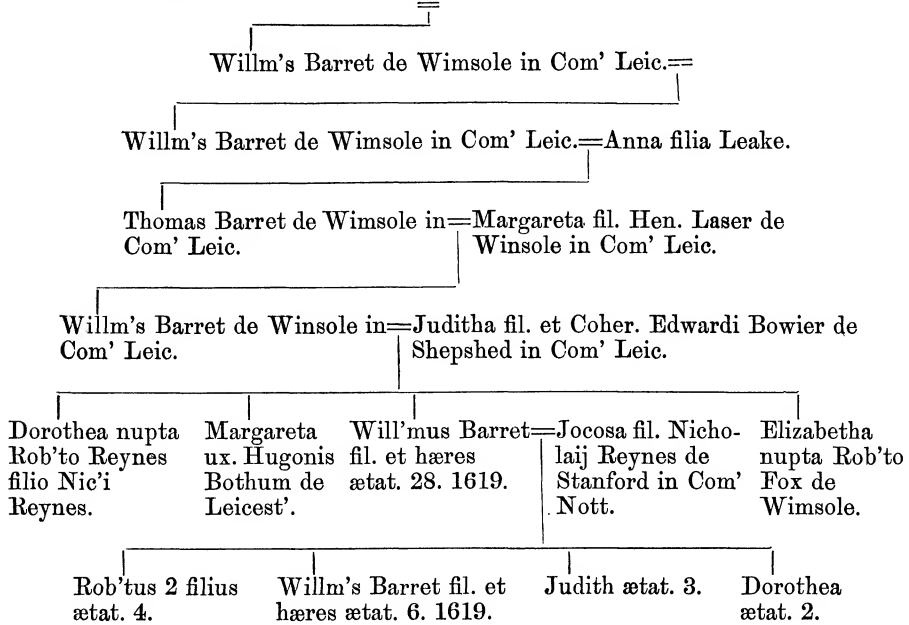

(Cheseldon.)

Johannes Cheseldon de Weldon in Com' Northam.

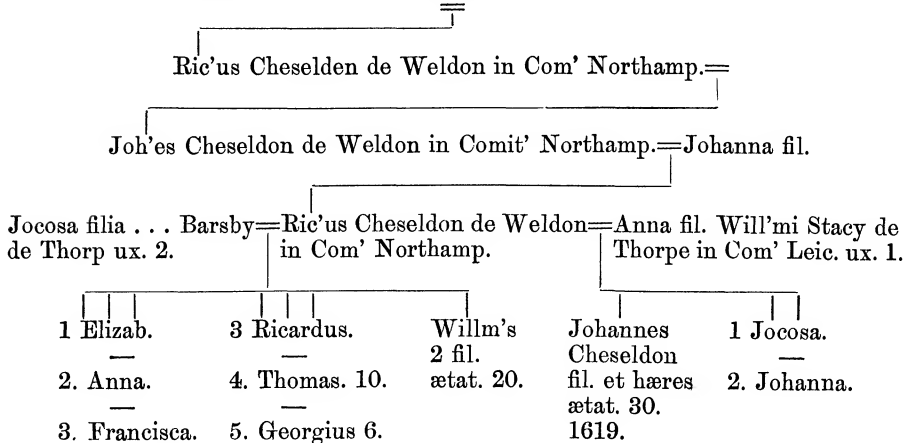

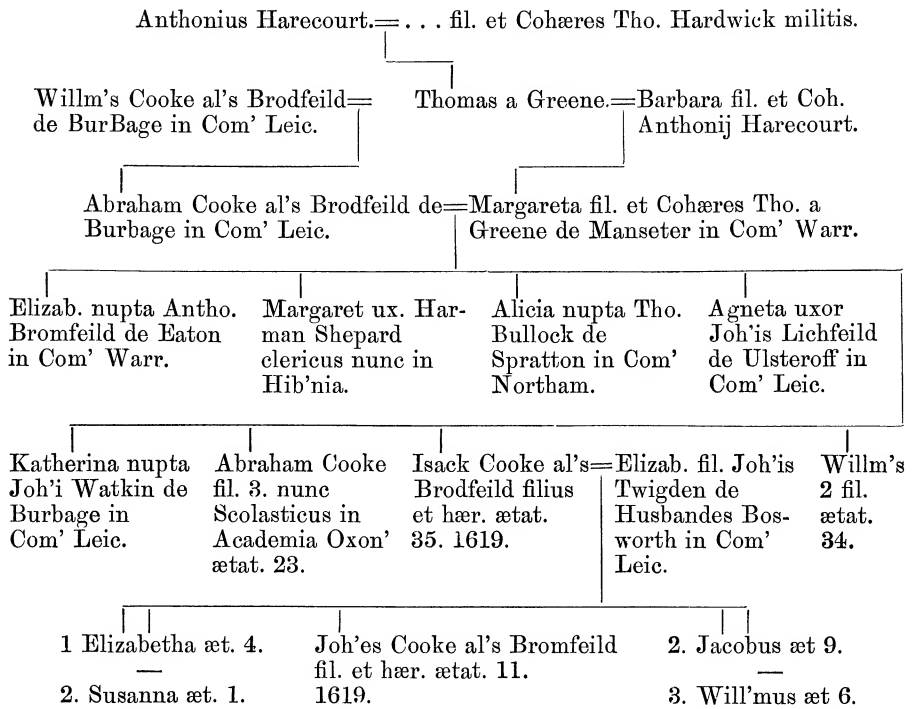
(Cooke.)**(Arms and Seals of Leicester.)**

ARMS. 1. *A cinquefoil pierced ermine.*

CREST. *A dragon with wings displayed and tail nowed ermine.*

2. *England, in chief a label of three points, the shield surmounted by a ducal coronet.*

SEALS.—1. *A cinquefoil pierced ermine.*

Legend.—✠ SIGILLUM : COMMUNITATIS : LEYRCESTRIE.

2. *Issuant from clouds a sheaf of three arrows, points downwards, one in pale and two in saltire, on the dexter side a scroll, inscribed thereon "IN ANTITRINITARIOS," on the sinister a cinquefoil pierced ermine.*

Legend.—✠ SIGILL : HOSPITALIS : S'CTÆ : TRINITATIS : IN : NOVO : OPERE.

3. *A cinquefoil pierced ermine.*

Legend.—✠ SIGILLUM : STATUT : BURGI : LLICESTRIE.

4. *A cinquefoil pierced ermine.*

Legend.—✠ VILLA . LEIC . TARLAT.

5. *The Virgin crowned, holding a sceptre in the dexter hand and nude child in sinister arm, seated under a canopy with finials, below them on a small shield, a cinquefoil pierced ermine.*

Legend.—SIGILL : MAIORATUS . VISTE : LEICESTRIE.

These are the Armes and towne Seales used by the Maior & Burgesses of the Borough of Leicester, w^{ch} now is incorporated by the name of Maior Bailiffes and Burgesses of the sayd Borough of Leicester, and inabled with many great priuileges and large immunities by many the auncient Kinges of England, and sithens confirmed & enlarged by Kinge James that now is. Of which sayd Borough at the tyme of this present Visitac^on. videl't 23. Septemb. 1619. Nicholas Gillott was Maior, Will'm Morton Will'm Iue, Tho. Erick & Rowland Pusey Justices of the Peace wthin the sayd Borough, John Wilne & Will'm Hunt Bailiffes, John Freman Steward John Tatam & John Norrice Chamberlaines and Fran Haruy Esq. Sergeant at Lawe Recorder of the sayd Borough.

(Allen.)

ARMS. *Per pale argent and sable, a chevron between three talbots passant, all counter-changed, the talbots collared or.*

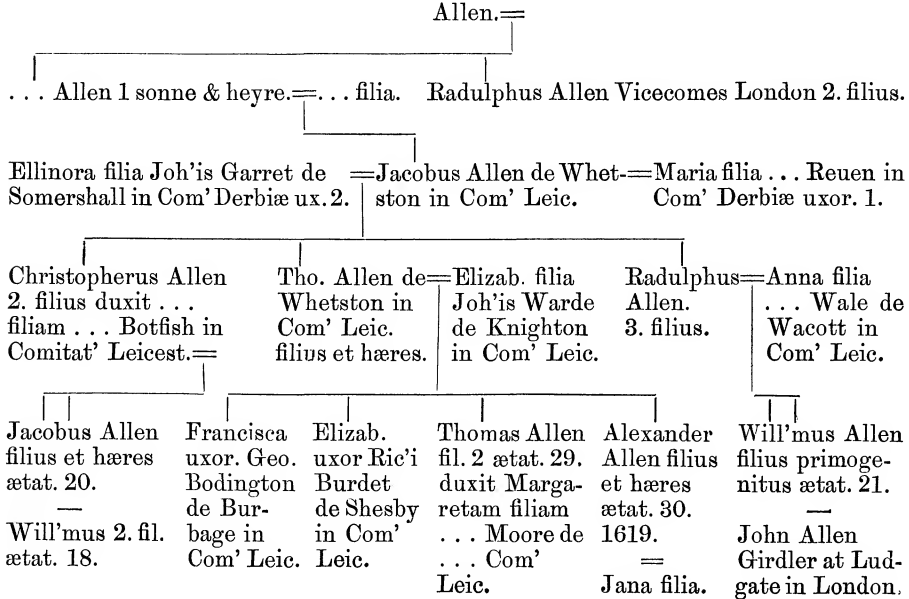

(**Skeffington.**)

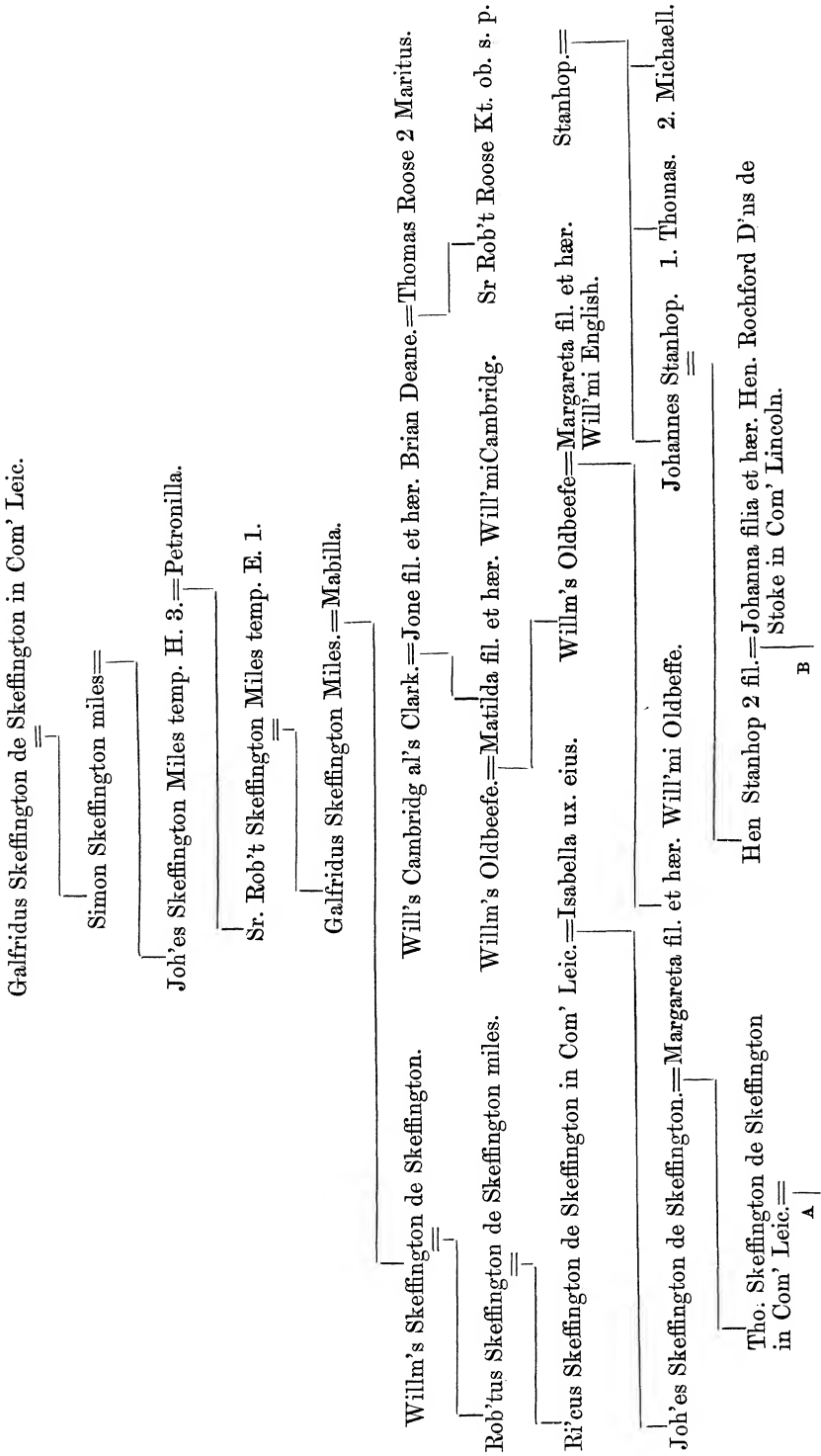

B

Anna filia Euerard Digby de Dristoke militis = Willm's Skeffington Miles Prorex = Anna filia John Digby Edmondus = Alicia
 et D'ns de Tilton in Com' Leic. ux. 1. Hib'niæ temp. H. 8. de Kettleby. Stanhop. Flie.

Thomas Skeffington de Skeffington. Margareta filia et hæres Edm. Stanhop Miles.

Katherina uxor Anthonij Colley de Glason or Glowson.
 2. Anna.
 3. Isabella.

Joh'es Skeffington de London. filia et hæres . . .
 Miles 2 filius Or, 3. eagles disp. sa. ob. s. p.
 Tho. Skeffington 3. filius duxit . . .
 filiam . . . Haslirigge. =

Elizab. uxor Geo. Griffith de Wichmore in Com' Staff. militis.

Willm's Skeffington de Com' Salop. Johanna filia Jacobi Leueson Ar. renupta Will'o Foulke et postea uxor Edwardi Gifford Ar. illa ob. 1572.

Arms. Quarterly:—1. Argent, three bulls' heads erased sable, armed or. 2. Azure, a bend cotised between six mullets or. 3. Sable, three garbs argent. 4. Azure, on a bend or, in dexter chief point an annulet gules for difference. 5. Ermine, on a chief indented gules three escallops or. 6. Or, a pale azure, a chief vert. 7. Ermine, a bend azure. 8. Or, three eagles displayed gules.

Joh'es Skeffington de wick in Com' Staff.

Alicia filia Thomæ Caue de Stanford in Com' Northamp.

Thomas Skeffington Legum Doctor 3. fil.

1. Elizabetha. 2. Ursula.

Will'mus Skeffington de wick in Com' Staff. 1619.

Elizab. filia Ric'i Deering de Pluckley in Com' Cantij.

Elizab. uxor Francisci Danuers de Swithland in Com' Leic.

Joh'es Skeffington filius et hæres = Ursula soror et cohær. Joh'is Skeffington de Skeffington. etat. 30. 1619.

Elizab. nupta Will'i Jetter de Skeffington in Com' Leic.

Elizab. filia Danuers relicta Tho. Caue. filia Bradley de London relictæ Will'i Cockeram de Hampsted in Com' Midd.

Georgius Skeffington fil. 3. duxit Godtham filiam Tho. Ros de Luttenworth in Com' Leicest. filius.

Ric'us Skeffington de London Justiciar' ad pacem 4. filius.

A

A B

<p>A</p>	<p>B</p>	<p>... filia monialis apud Sempringha.</p>	<p>Jocosa ux. . . . In-garsby de Kibworth in Com' Leic.</p>	<p>Maria uxor Ouerey de Iueston in Com' leic. renupta . . . Kingston.</p>	<p>2. Leonardus.</p>	<p>3. Anthonius Presbiter.</p>		
<p>A</p>	<p>B</p>	<p>7. Jocosa uxor Tho. Bendage de Burrington in Com' Cantab.</p>	<p>5. Elizab. ux. Ri. Egleby de Estcot in Com' War.</p>	<p>3. Katherina uxor Georgij Pochin de Barkby in Com' Leic.</p>	<p>2. Anthonius s. p.</p>	<p>1. Isabella uxor Rob'ti Belgraue de Kilworth in Com' Northamp.</p>	<p>Will'mus Skeffington de Skeffington sup' stes 1563.</p>	<p>== Maria filia Tho. Caude de Stanford in Com' Northamp.</p>
<p>A</p>	<p>B</p>	<p>8. Maria uxor Rob. Monke de Kirkby in.</p>	<p>6. Lucia uxor . . . Bell.</p>	<p>4. Dorothea uxor Tho. Hunt de Aston sup' Trent in Com' Nott.</p>	<p>4. Georgius s. p.</p>	<p>2. Anna uxor Tho. Ludford de Anseley in Com' War.</p>	<p>2. Anna uxor Tho. Ludford de Anseley in Com' War.</p>	<p>2. Anna uxor Tho. Ludford de Anseley in Com' War.</p>
<p>A</p>	<p>B</p>	<p>4 Alicia uxor Bandon de Kibworth in Com' Leic.</p>	<p>Agneta 3. filia.</p>	<p>Margaret 1 filia.</p>	<p>Henricus 2. filius.</p>	<p>Thomas Skeffington de Skeffington in Com' Leic. Ar. ob. 1600.</p>	<p>Isabella filia Joh'is Biron de Newsted in Com' Nott militis.</p>	<p>Isabella filia Joh'is Biron de Newsted in Com' Nott militis.</p>
<p>A</p>	<p>B</p>	<p>Elizab. soror et Coh. uxor Will'i Jettour de Warwick.</p>	<p>Maria soror et Coher uxor Will'mi St Andrew de Gotham in Com' Nott.</p>	<p>Katherina soror et hær. uxor Will'mi Brome de Woodlow in Com. Warr. ar.</p>	<p>Joh'es Skeffington frater et hares Will'i occisus in Hospitio Graues Inne London p' Mich'em Bray sine prole.</p>	<p>Will'm's Skeffington de Skeffington miles ætat. 20. A.º 1600 ob. s. p.</p>	<p>Katherina filia Ric'i Chetwood de Woodhull in Com' Bedf. mil.</p>	<p>Michael Bray 2 maritus occisus in hospitio Grayes Inne London per Joh'em Skeffington.</p>
<p>A</p>	<p>B</p>	<p>Joh'es de St Andrew.</p>	<p>Gulielmus de St Andrew 2 filius.</p>	<p>Jana. Barbara.</p>	<p>Ric'us Bray 1 filius.</p>	<p>Egidius 2 filius.</p>	<p>Anna ob. 16. July 1618.</p>	<p>Anna ob. 16. July 1618.</p>

(Noel.)

ARMS. *Or, fretty gules, a chief azure.*

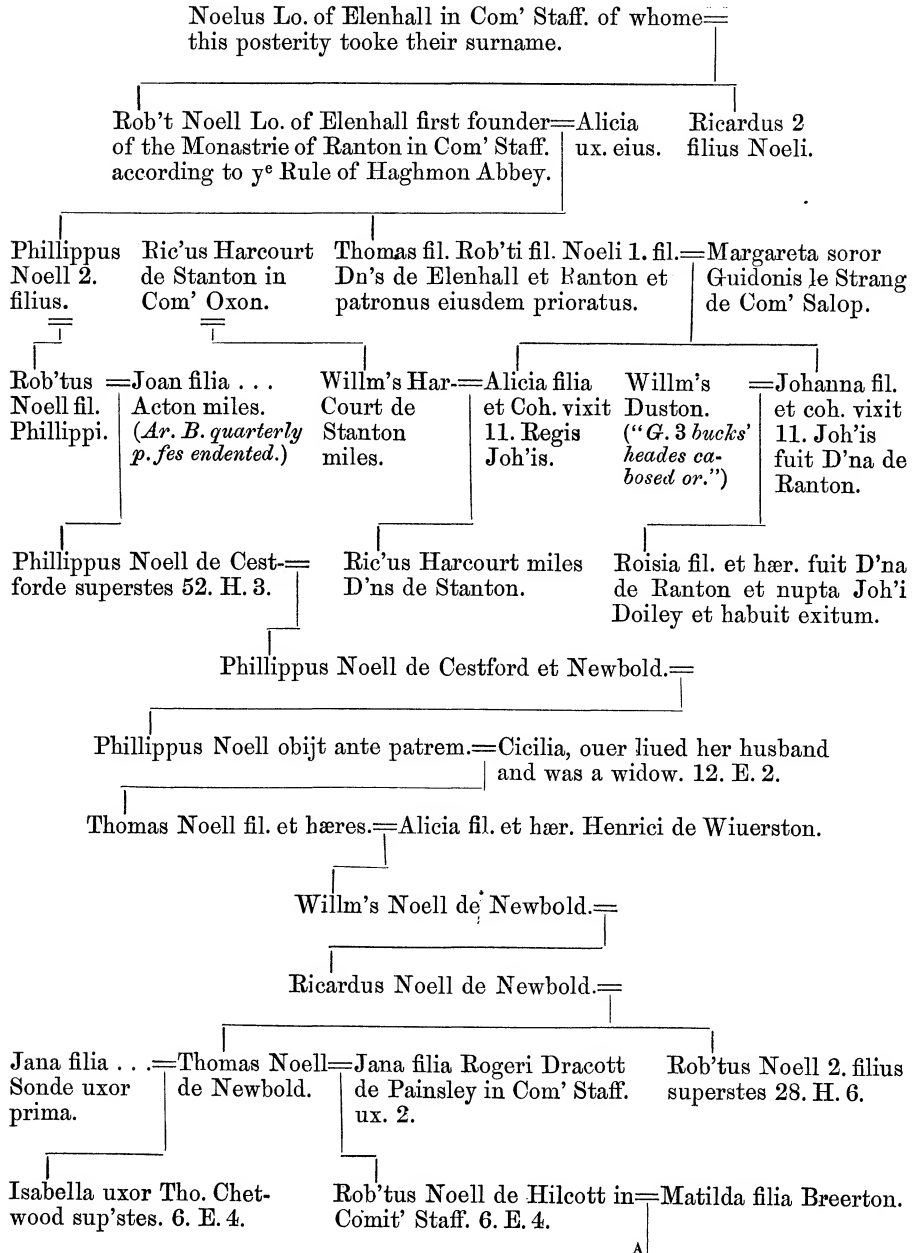

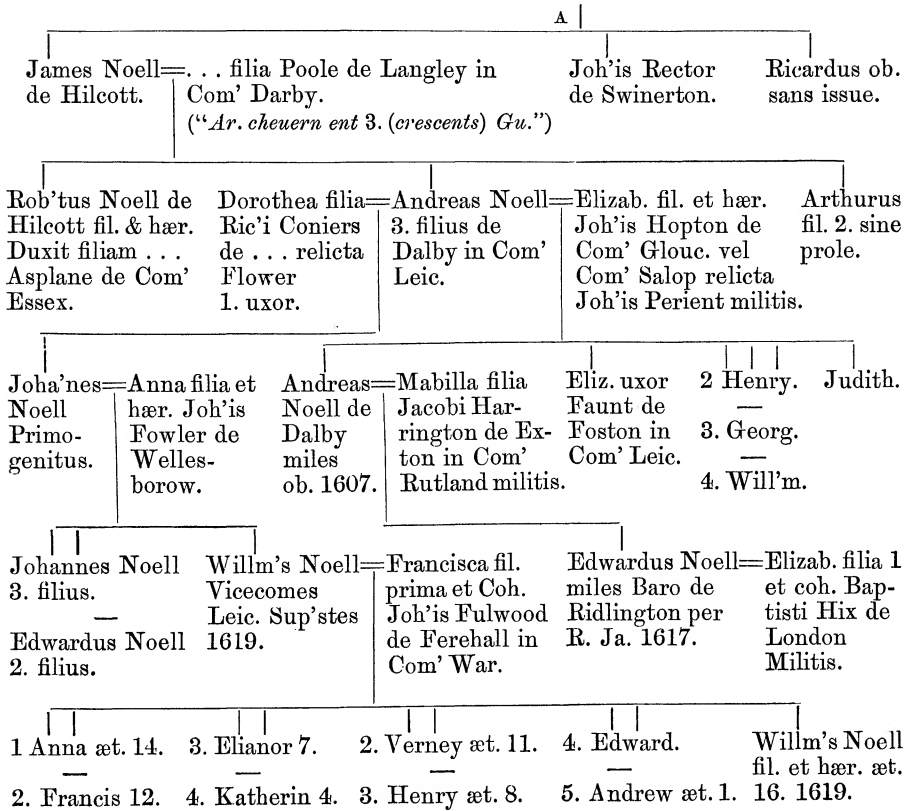

(Noble.)

ARMS. *Quarterly*:—1. *Argent, on a chief gules a lion passant or.* 2. *Barry of six argent and sable, on a canton gules a crescent or.* 3. *Argent, on a bend sable five bezants.* 4. *Gules, a chevron ermine between three eagles displayed or.*
 CREST. *An eagle displayed or.*

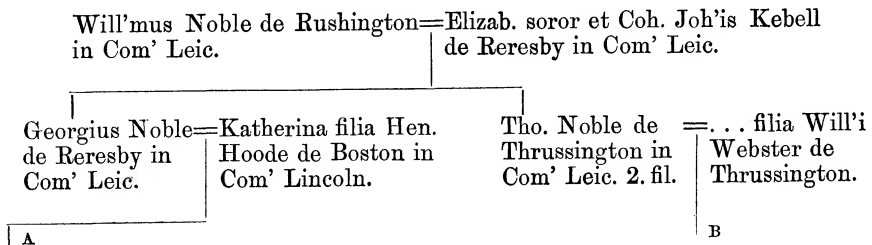

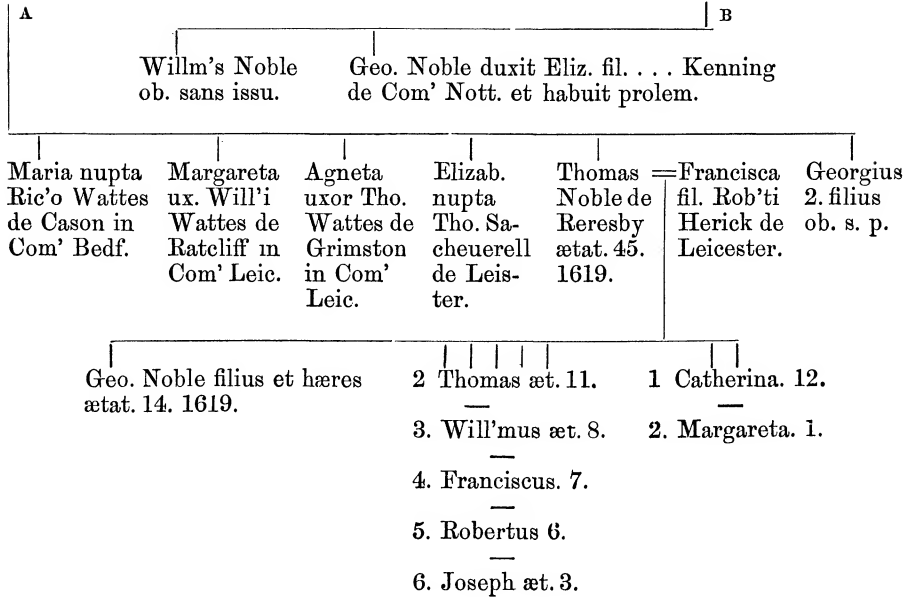

Sr Beaumont Dixsey.

† ARMS. *Quarterly*:—1. *Azure, a lion rampant and chief or.* 2. *Argent, a saltire engrailed between four escallops sable.* 3. *Argent, on a saltire gules five cross crosslets or.* 4. *Sable, a chevron between three mullets argent.* 5. *Sable, a bend between six étoiles or.* 6. *Argent, on a saltire engrailed gules a mullet or.* 7. *Azure, a lion rampant between five fleurs-de-lis or.* 8. *Azure, three garbs or.* 9. *Gules, seven mascles conjoined or.* 10. *Gules, a cinquefoil ermine.* 11. *Gules, a pale or.* 12. *Azure, a lion rampant argent, crowned or.* 13. *Argent, an inescutcheon within a tressure flory counterflory gules.* 14. *Gules, a saltire argent.* 15. *Azure, a wolf's head erased argent, langued gules.* 16. *Gules, a lion rampant vair.* 17. *Azure, a fess argent between three cinquefoils or.* 18. *Argent, a maunch sable, in chief a crescent for difference. (The Ulster badge.) Impaling quarterly*:—1. *Or, on two bars gules three water bougets of the field.* 2. *Vert, three stags trippant proper.* 3. *Gules, three bars argent.* 4. *Argent, a chevron engrailed between three trefoils slipped sable.* 5. *Sable, a saltire engrailed between four cross crosslets or.* 6. *Ermine, on a fess gules three annulets or.* 7. *Paly of six, argent and azure.* 8. *Argent, a mullet sable.* 9. *Argent, on a bend (untinctured) between six martlets gules three bezants.*

CREST. *An ounce séjant proper, ducally gorged or.*

“Two Atcheivm^{ts} to be by monday morning
Early into the Country. Ell square.”

† This does not form part of the Visitation, but has been inserted.

(Dixie.)

ARMS. *Quarterly:—Azure, a lion rampant and a chief or; and argent, a saltire engrailed between four escallops sable.*

CREST. *An ounce séjant proper, ducally gorged or.*

MOTTO. *Quod dixi, dixi.*

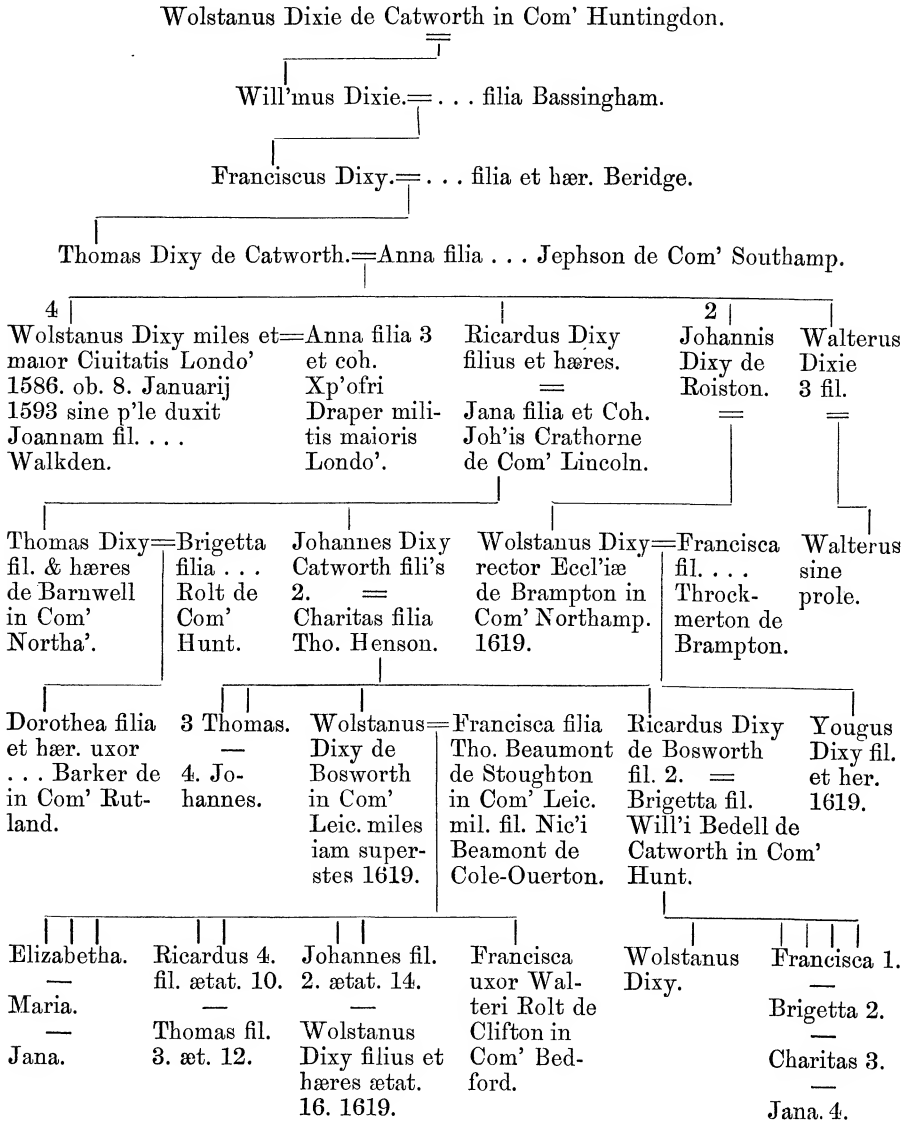

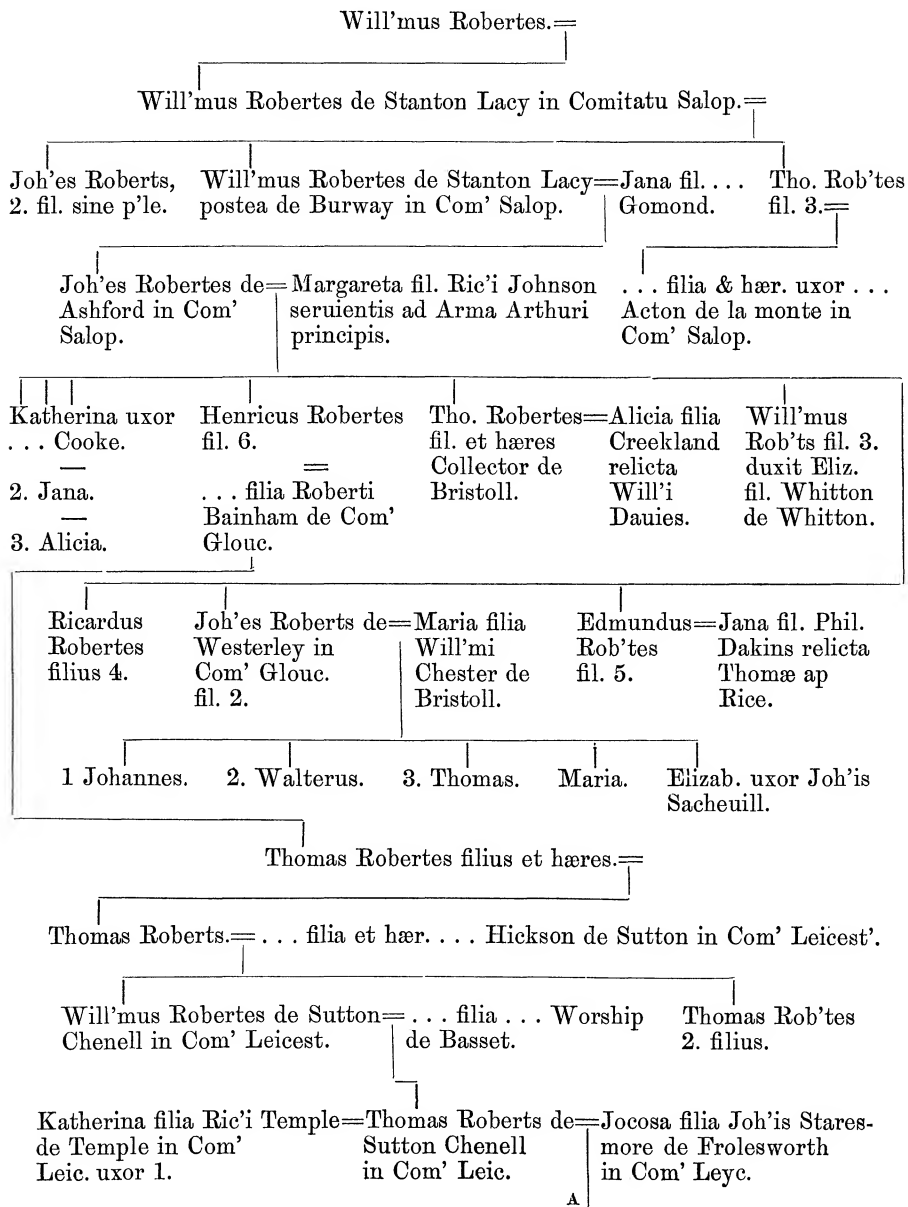
(Robertes.)ARMS. *Per pale argent and gules, a lion rampant sable.*CREST. *An heraldic antelope's head erased per fess argent and gules.*

(Sturton.)

ARMS. *Quarterly*:—1. *Sable, on a bend or between six fountains, in dexter chief a mullet for difference* (STURTON). 2. *Gules, three bends engrailed or* (COWLEY, STAFFORDSH.). 3. *Gules, on a chevron between three bezants as many crosses pattée fitchée sable* (SMITH, LEICEST'SH.).

CREST. *A demi friar, vested russett, skirted gules, cowled proper, in the dexter hand a discipline of three thongs, and in the sinister a church or.*

ANOTHER CREST. *An arm, coupéd at the elbow, erect, vested per pale or and gules, in the hand proper a griffin's head erased azure.*

Certified under the hand & seale of Sr. W. Segar Garter & confirmed to John and Edward Sturton Brothers A° 1616.

Thomas Sturton de Sturton in Comitatu' Nottingham.

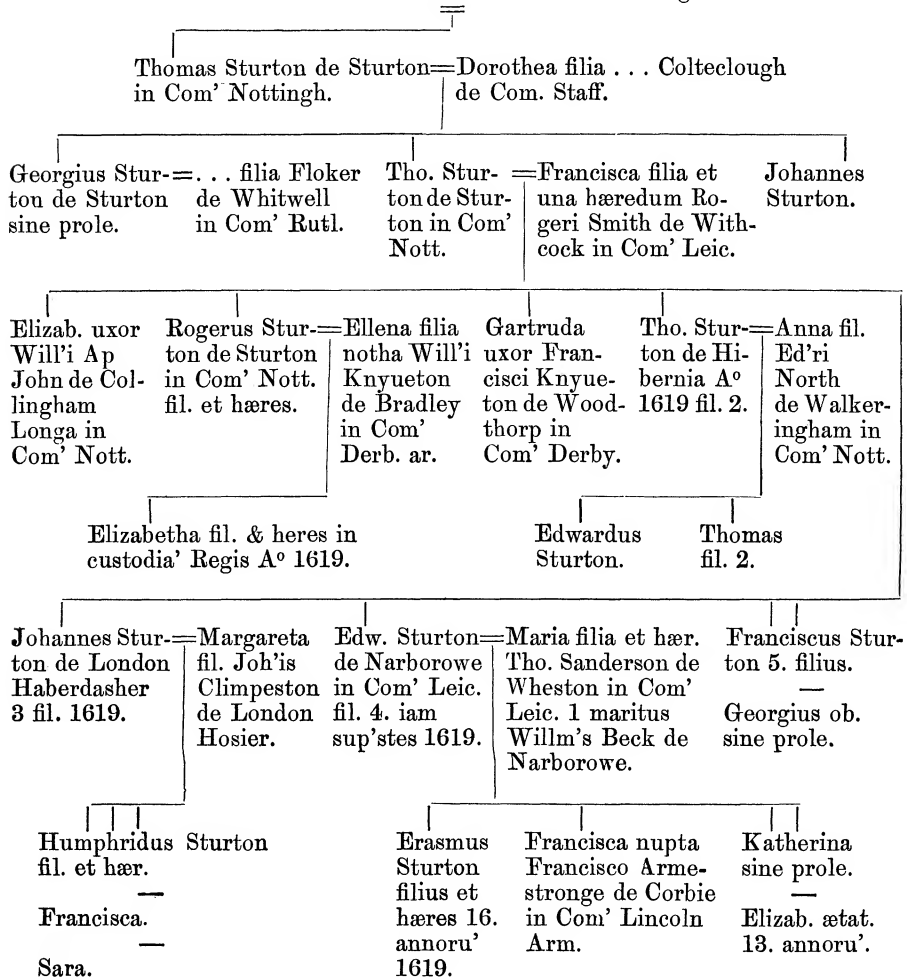

(Cabe.)

Franciscus Caue de Bagraue in Com' Leic. iuris=Margareta filia Tho. Lisle
 ciuilis Doctor 4. fil. Ric'i Caue de Stamford. | de Com' Surrey.

1. Thomas.	Henricus Caue de Barrow 4.	=	Phillippa fil. unica hæres	Lisley Caue 5. fil.	
—	—		Rob'ti Bra- ham de Bar- row sup' Sore.	—	
2. Anthonie.	—		—	1. Margaret.	
—	—		—	—	
3. Brian.	—		—	2. Dorothy.	
—	—		—	—	
Margareta uxor Adriani Babington rectoris de Cossington.	2. Will'mus æt. 24. — 3. Edwardus æt. 23. — 4. Thomas æt. 20. — 5. Henricus æt. 17.		Theophilus= Caue filius et hæres æt. 34.	Isabella filia Joh'is Allen de Sibley in Com' Leic.	Annanupta Will'o King de Edmon- thorp in Com' Leic. — Katherin Virgo.

Tutbury in Com' Staff. opidum antiqui nominis floruit sub regno Saxonu' pos-
 tum sub ripam fluminis Doue quod Willm's Conquestor rex Angliæ dedit Hen-
 rico de Ferrarijs qui Castrum elegans et monasterium ibidem fundauit. Hoc
 oppidum præbuit sedes multis familijs, inter alias familia de Burton cuius aedes
 ibidem dictæ Burton hall, et terræ vicinæ Burton Bache, Burton More Burton
 Holme, Burton hill, et Burton scheid. Ex hac familia Jacobus de Burton miles
 officio Scutiferi functus est regi Ric'o primo in bello Sacro et alibi, hunc Joh'es
 Rex fecit magistrum fofestarum quam donac'onem Henricus rex tertius confirmauit.
 Adhæsit hæc familia Lancastrensi et filius eius Oliuerus factus est Seneschallus
 honoris de Tutbury sub Johanne Gandauo D. Lancast' contra quem Ducem Ric'us
 Burton frater dicti Oliueri arrauiauit assisam Nonce desseisinæ filius tamen eius
 Willmus Burton partes Lancast'r sequutus est, atq' creatus fuit ab Henrico 6.
 rege Vexillarius eius. Diu habitauerunt illi apud Tutbury et Falde vicinum ubi
 multa priuilegia et tenuras habuere, inter quas tenura de Morton nunc Alcock de
 Coton Com' Stafford qui tenuit terram suam in Coton de Burton, per fidelitatem
 et vi^s viii^d annui redditus et reddendo ad obitum cuiuslibet hæredis optimum talum
 inuasorium, quod nuper præstitum fuit. Locus sepulturæ fuit in Capella Sc'i
 Stephani in monasteria beatæ Mariæ de Tutbury; Willm's Burton Vexillarius
 Hen. 6 regis struxit aedes apud Falde, ibidemq' habitauit Rad'us filius eius trans-
 tulit sedem ad Mafeild iuxta Okeouer in Com' Staff.; Jacobus fili's Radi ducens
 in uxorem Elizabetham filiam natu maximam et cohæredem Joh'is Hardwick
 de Lindley in Com' Leic. a^o 3. H. 8. tunc mutauit sedem suam ad Lindley ubi iam
 a^o 1619. Radulphus eius ex filio Roberto nepos movatur, et Will'mus Burton filius
 dicti Rad'i nunc a^o 1619. inhabitat apud Falde prædictum.

ARMS. *Quarterly*:—1. *Azure, a fess between three talbots' heads erased or.* 2. *Or, three stars gules pierced of the field.* 3. *Azure, on a chevron argent three catharine wheels gules.* 4. *Azure, an eagle displayed argent, armed or.* 5. *Gules, a saltire engrailed argent between four mullets or.* 6. *Azure, semée of cinquefoils (untinctured).* 7. *Or, two bends cotised azure.* 8. *Argent, a fess gules, in chief three mullets sable.* 9. *Gules, three eagles displayed or.* 10. *Vair (untinctured), a chevron (untinctured).* 11. *Or, fretty sable, each joint charged with a cross crosslet fitchée argent.* 12. *Gules, on a bend or, three garlands vert.*

CRESTS. *First, a beacon argent, ladder or, inflamed proper.* *Second, out of a ducal coronet a cypress-tree vert, semée of cinquefoils or.*

(Plumbe.)

ARMS. *Ermine, a bend vair, cotised sable; impaling a bend engrailed, cotised (untinctured).*

CREST. *On a mount vert a greyhound séjant argent, collared gules.*

Walterus Plumbe de Aldeburgh in Com' Norff.

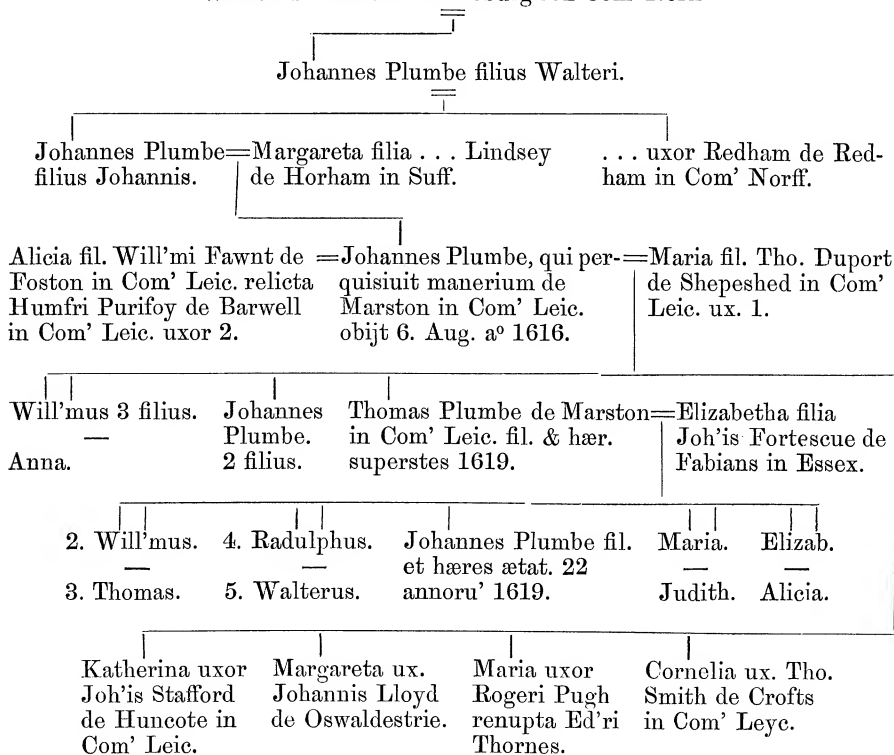

(Cabe.)

ARMS. *Quarterly*:—1. *Azure, fretty argent.* 2. *Ermine, on a bend sable three fishes' heads erased argent.* 3. *Argent, a chevron between three birds vert.*

CREST. *A greyhound courant sable, collar (untinctured).*

ARMS OF SAMPSON. *Sable, a cross flory between four escallops sable.*

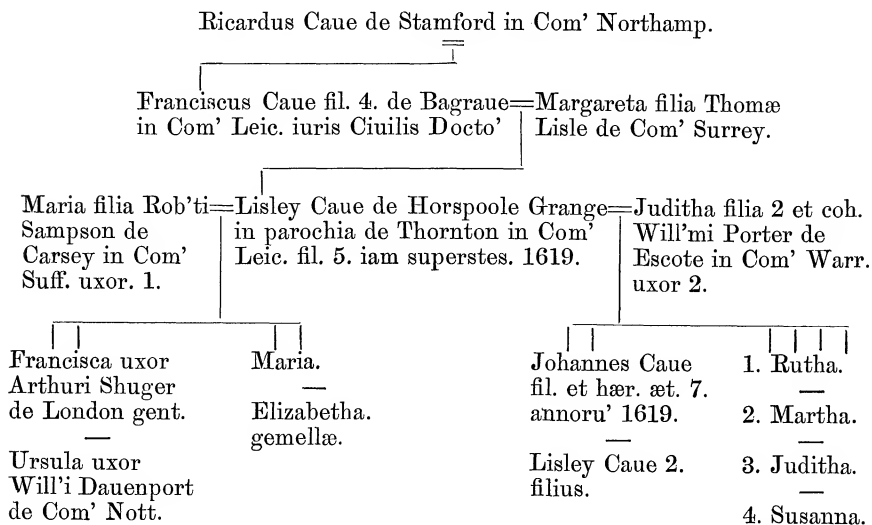

(Charnells.)

ARMS. *Quarterly*:—1. *Azure, a cross engrailed or.* 2. *Argent, three fleurs-de-lis between six cross crosslets fitchée sable, three, one and two.* 3. *Argent, three garbs azure.* 4. *Argent, three eagles displayed gules within a bordure engrailed sable.*

CREST. *Out of a coronet (untinctured) a demi-plover or, with wings displayed argent; against it is written "a puet."*

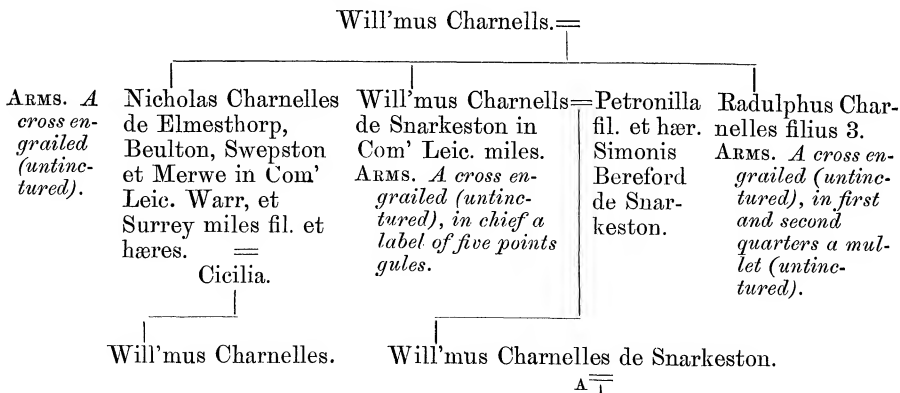

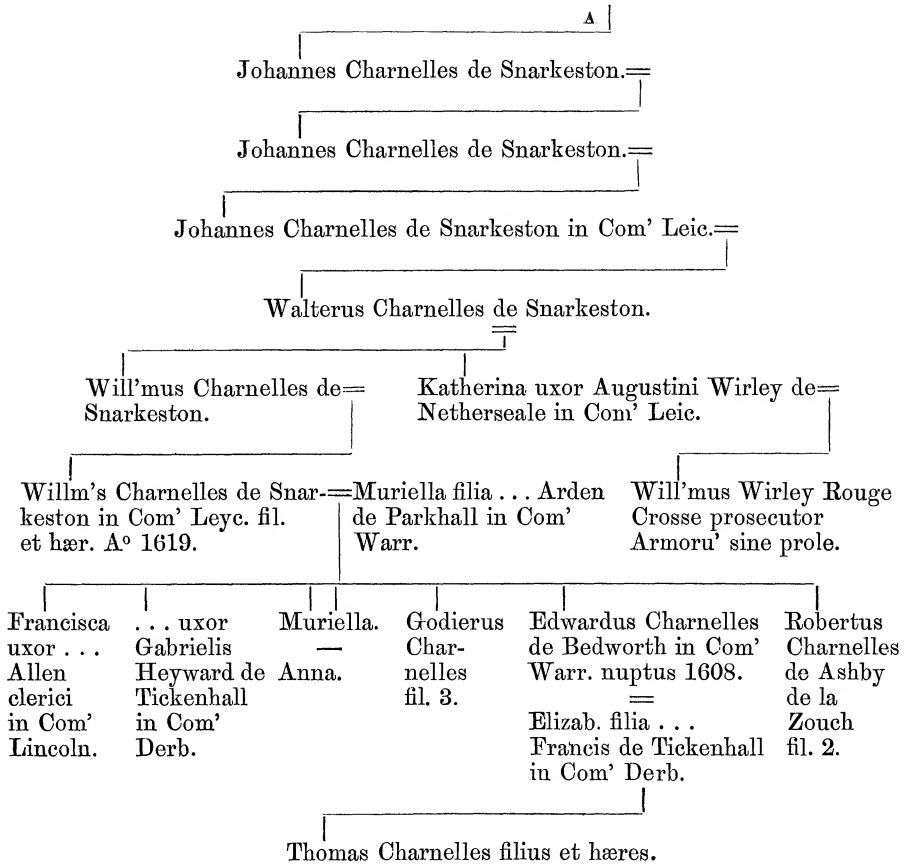

(Duport.)

ARMS. *Quarterly:—Per chevron embattled a crescent in dexter and a mullet in sinister chief, in base a lion rampant, within a bordure (all untinctured); and argent, three fusils in fess gules between three pellets.*

CREST. *On a rock argent guttée de sang, a falcon* proper, beaked gules; against the wings is written "blowish."*

MOTTO. *Invitis ventis.*

"Guillaume Segar, Jartiere Roy principall d'Armes."

ANOTHER. *Per chevron embattled azure and sable, in dexter chief a crescent argent, and in sinister a mullet or, in base a lion rampant of the last, within a bordure gules.*

CREST. *On a rock vert a falcon proper.*

SUPPORTERS. *On mounts two savages wreathed about the middle with leaves all proper, each brandishing in the dexter hand a spiked club argent.*

* Arms tricked by Nicholas Charles, Lancaster Herald (Harl. MSS. 1113, fo. 10). "Henricus Du Porte de Shepeshed" gives the crest thus: upon a rock "a halcion" proper, in its beak a scroll inscribed "Invitis ventis," and beneath the shield a second motto, "Portum Teneo."

La Genealogie Armories et Supporteurs fort anciens de Monsieur Duport iadys demourant aupres La Riuiere au port de Caen en Normandie de la quelle ilz puint leur nom et astheure sont resiant en le Comté de Lecestre en Angleterre.

Ces deux Sauuages defendant leur testes avec leur Bastons furent donnez a l'Ancestre du dict Guillaume a son retour en Normandie avec Guillaume le Conquerant apres la conquest d'Angleterre come ill appert par ung viel Genealogie.

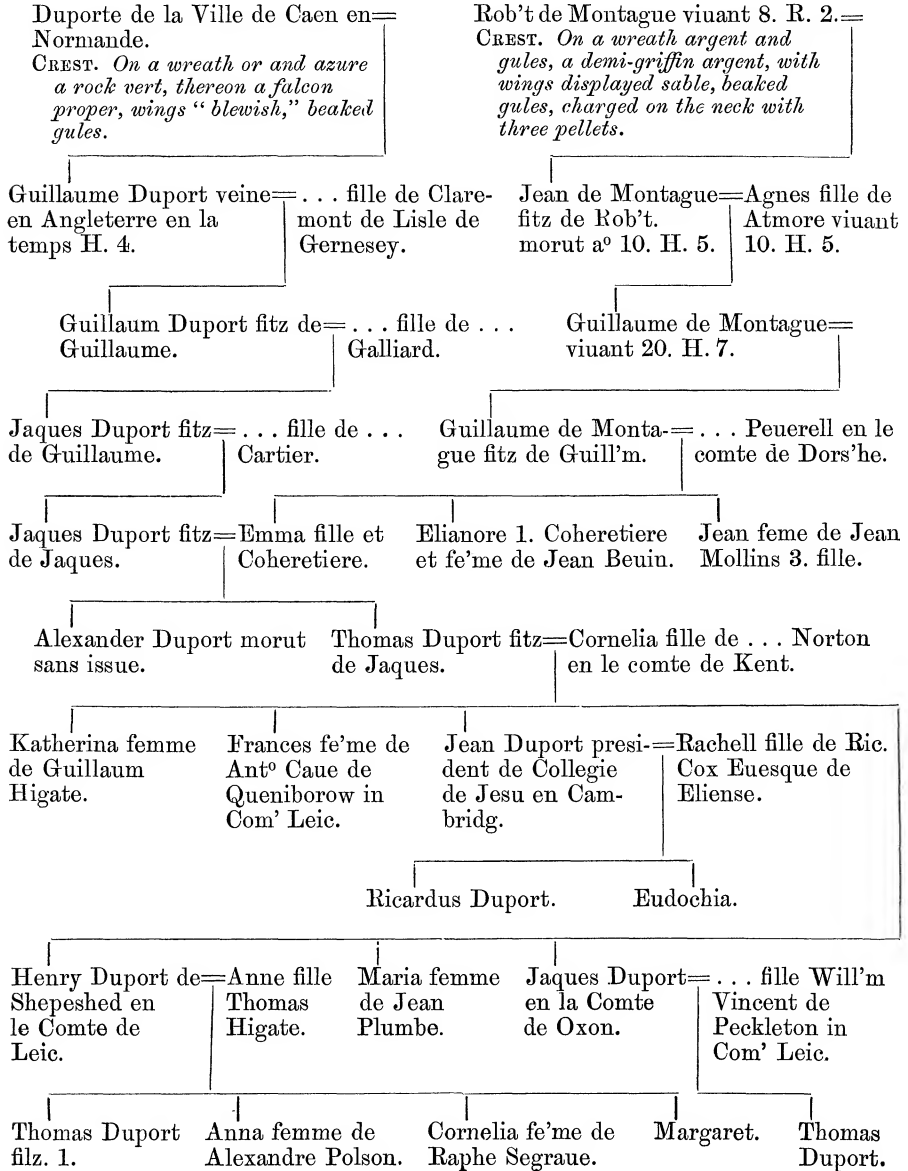

(Caue.)

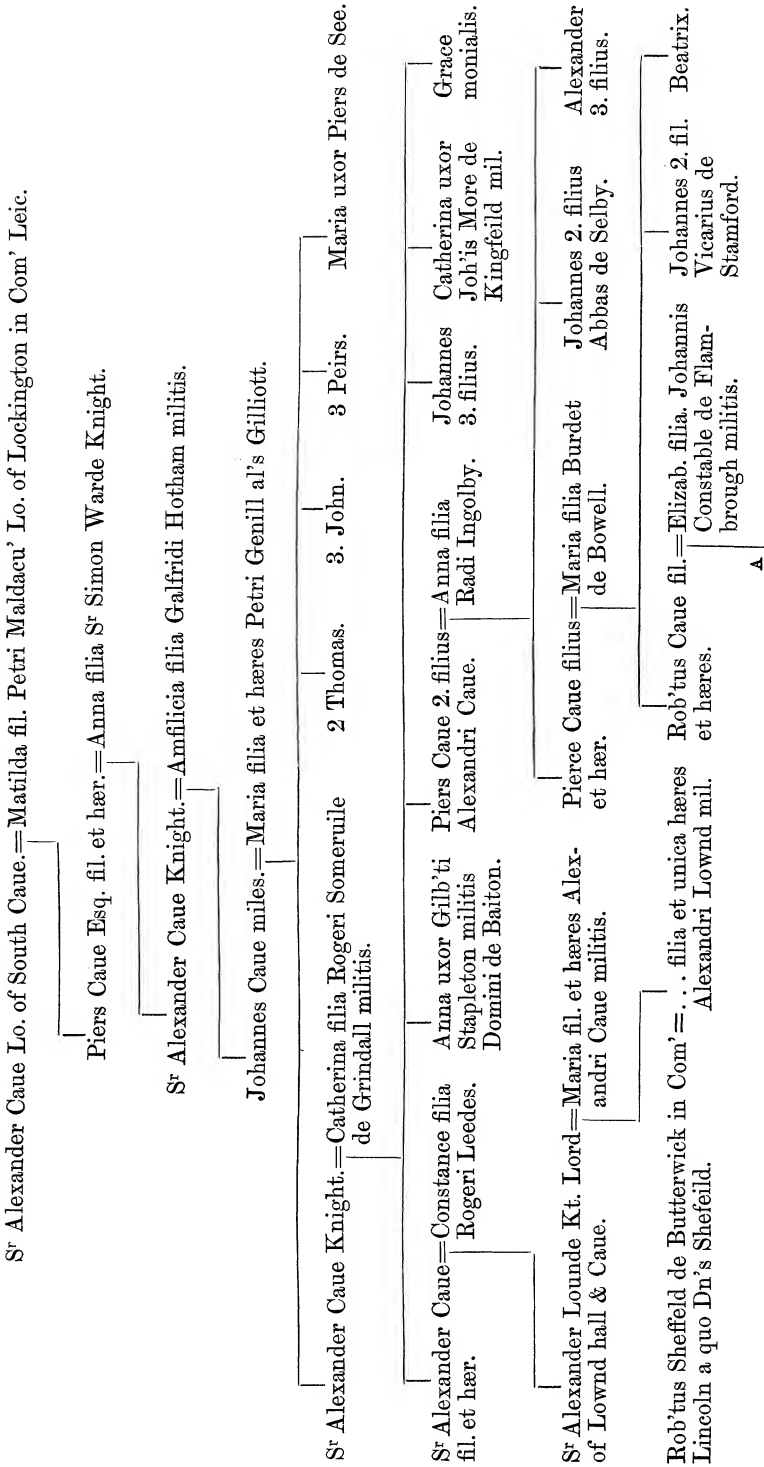

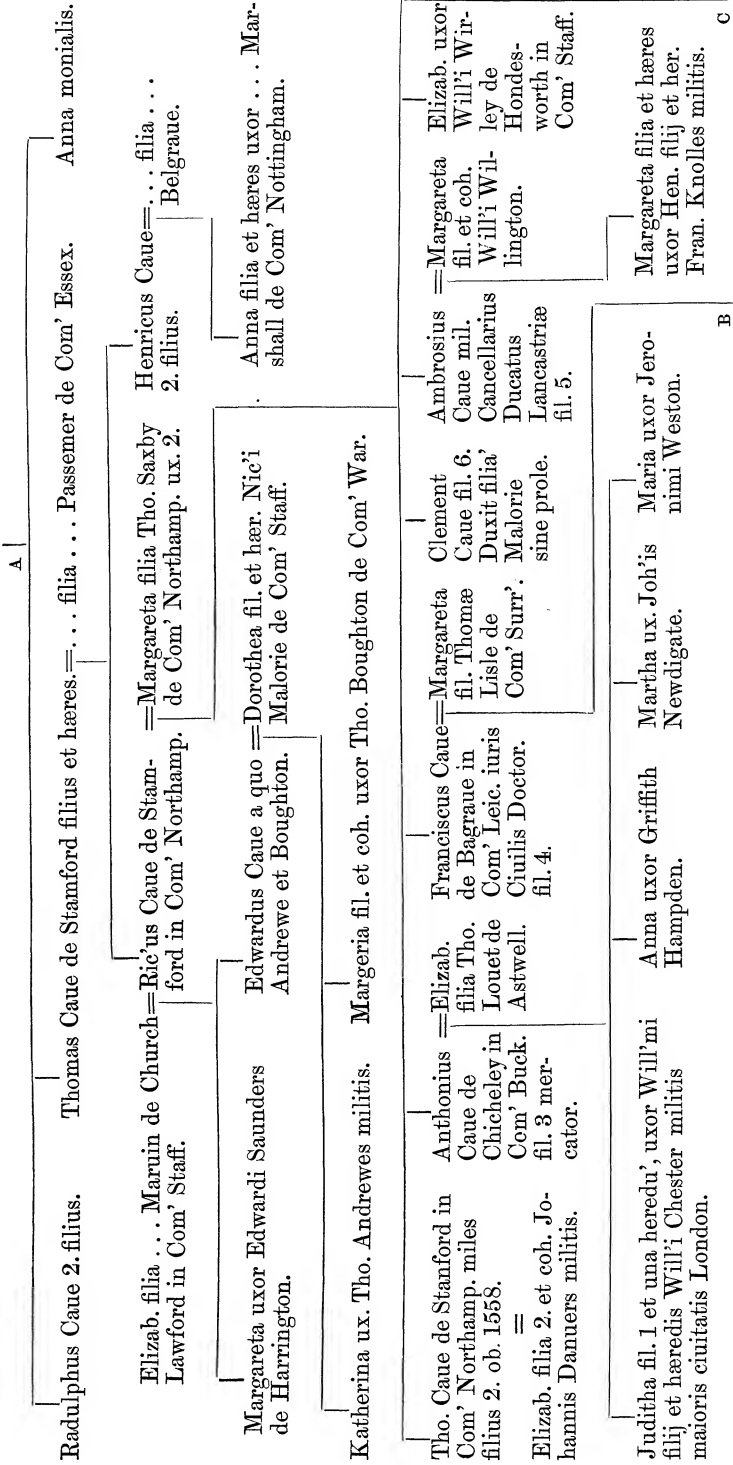

A

B

C

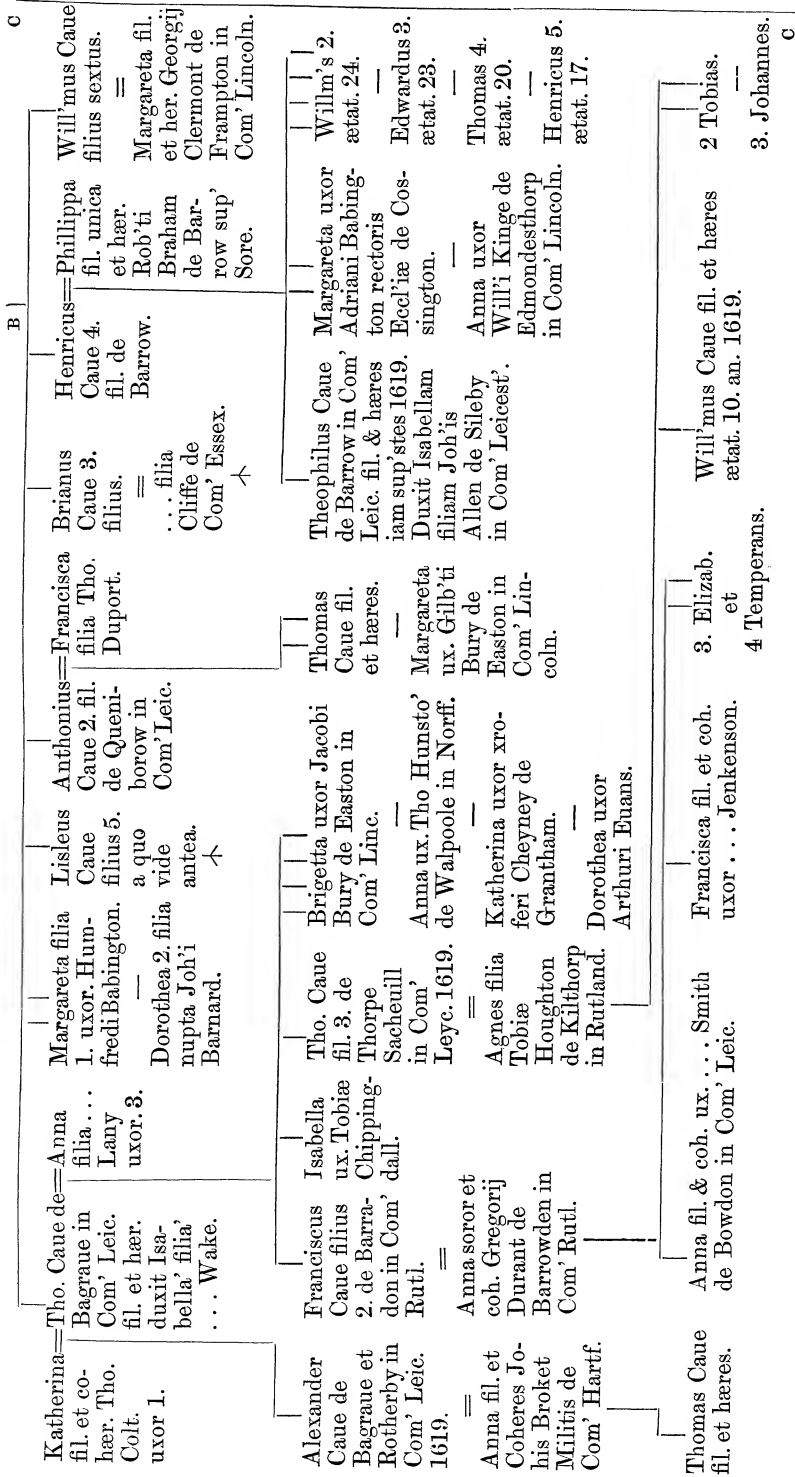

				c			
Ricardus Caue= de Pickwell in Com' Leic. filius 7.	Barbara filia Will'i Feilding de Newenham militis.	Augustin's fil. 9.	Dorothea ux. Will'i Smith al's Harris de Withcock in Com' Leic.	Prudencia uxor Joh's Crooke al's Blount unus sex Clericorum Cancellariae.	Brianus Caue= de Ingarsby in Com' Leic. fil. 8.	Margareta filia Geo. Throck- morto' militis.	Brigetta uxor Francisci Tanfeld de Gaiton in Com' Northamp.
Will'm's Caue de Pick- well in Com' Leic. Duxit Elizab. fil. . . . Burnell de Wingburn in Com' Nott.	Elianova filia Tho. Gray de Enuill in Com' Staff. uxor I.	Rosa uxor Harecourt renupta ... Hun- nings.	Anthonius Caue de London fil. 2. Duxit ... filiam. p'l.	Edw. Caue fil. et hæ. 1 ob. sine p'le. = Barbara fil. et coh. Will'i Deuereux militis.	1. Francisca. Henricus= Caue de Ingarsby in Com' Leic. 2. fil. et hæres.	Elizab. filia Geo. Isham de Pitchley in Com' Northamp.	
Franciscus= Caue fil. 3. de Cle- brooke in Com' Leic. a° 1619.	Margareta filia Joh's Trussell de Billesley in Com' Warr. relicta Georgij Cope.	Edwardus Caue fil. 4.	Elizab. filia et coh. Pauli Ewart de Gredington in Com' Northamp.	Johannes Caue de Pickwell in Com' Leic. sup'stes a° 1619 fil. 2.	Magdalena Bartholomei Armine de Osgoodby in Com' Lin- col uxor I.	Anna uxor Joh's Sherman de Leicester.	Maria uxor Steph'i Peck de Knossington in Com' Leic.
Will'mus Caue fil. et hæres.	Elizab. filia relicta Georgij Cope.	Marcia.	Will'mus Caue fil. et hæres a° 1619.	Maria filia et coh. Joh's White de Southwick in Com' South.	Johannes. 2. Johannes. 3. Thomas. 4. Francisus.	Johannes Caue fil. et hæres.	
Will'mus Caue æt. 1. anni.				Maria.	Anna 1. s. p.		

Ex Chartis Thomæ Hasilrigge de Nowesley in Com' Leicestriæ militis.

Sciant præsentis et futuri quod ego Herbertus de Karleton rector Ecel'ia de parua Boughton dedi D'no Anketino de Martiuall et Agneti uxori suæ et hæredibus &c. totum clameum &c. in situ unius molendini quem emi de Roberto de Tokeby in campo de Illeston una cum molendino ibidem constructo. Hijs testibus Rad'o de Martiuall Rad'o de Medbourne, Rob'to de Tokeby, Roberto de Karleton Waltero de Billesdon et alijs.

valde antiqua.

Uniuersis hoc scriptum visuris vel audituris Rob'tus de Martiuall de Haluton et Rad'us de Martiuall salutem, Noueritis nos pro D'no Joh'e Engærie teneri D'no Anketino de Martiuall in 40 marcis soluendis eidem aut suo attornato apud Nouesley &c. ad terminos subscriptos &c.; ita quod uterq' n'rum tenetur in solidum. Et ad istam soluc'oem loco et terminis præd'cis fideliter et plenariè faciendam obligamus nos et hæredes, et omnia bona nostra mobilia et immobilia ubicunq' existentia districtioni Vicecomitis Leicestriæ vel Balliuorum Comitatis Leicestriæ qui pro tempore fuerint siue districtioni eiusdem D'ni Anketini vel cuiuscunq' voluerit balliui, In cuius rei testimonium &c.

sanz Date.

(Martiuall.)

ARMS. *Argent, a cinquefoil sable.*

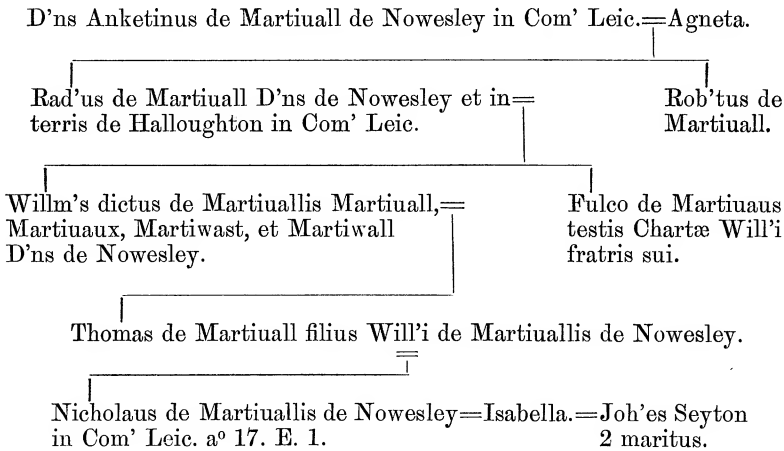

(Thame.)

ARMS. *Gules, on a chevron between three martlets or as many mullets sable, on a chief of the second three mascles of the field.*

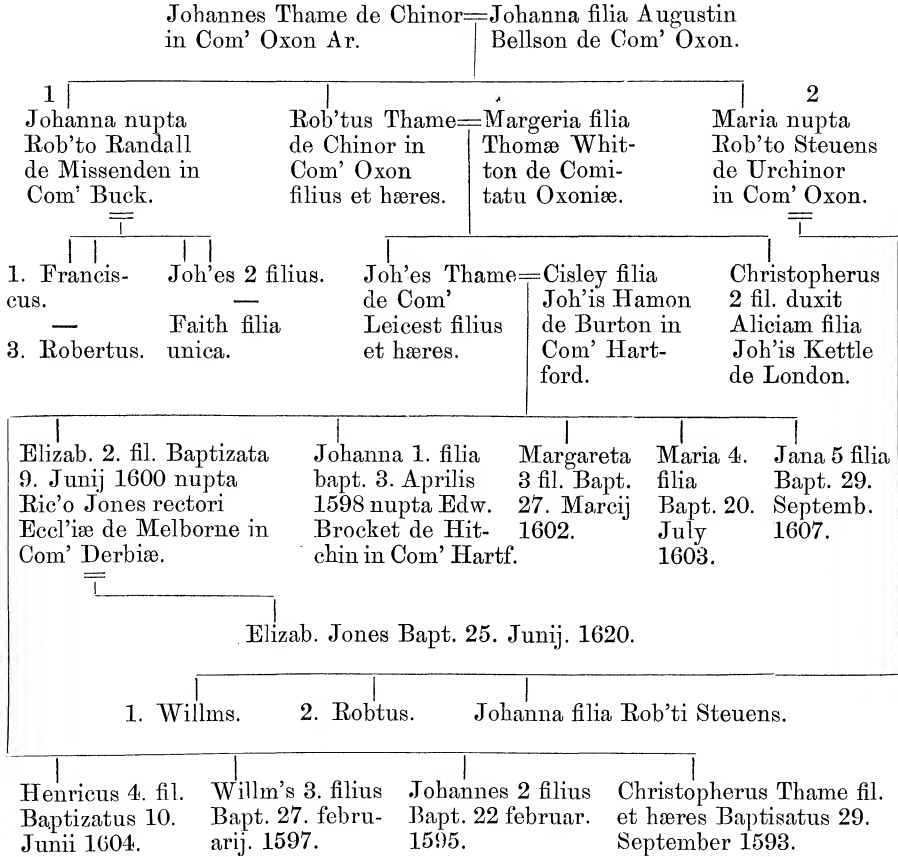
(Carrington *alias* Smith.)

ARMS. *Quarterly* :—1. *Argent, a cross gules between four peacocks azure.* 2. *Quarterly, argent and sable, in the first quarter a fleur-de-lis gules, and in the fourth, an ermine spot.* 3. *Argent, on a fess wavy sable three hares' heads erased or.* 4. *Quarterly gules and ermine, in the first and fourth quarters a goat's head erased argent.* 5. *Sable, three leopards' faces reversed gules, jessant-de-lis argent.* 6. *Ermine, a talbot passant sable.* 7. *Gules, on a bend or, three*

martlets sable. 8. *Barry nebulée of six argent and sable, a canton gules.* 9. *Per fess ermine and or, a cross moline gules.* 10. *Or, a fess azure between two bars gemelles (untinctured).* 11. *Sable, ten bezants four, three, two, one, on a chief ermine three lozenges gules.* 12. *Gules, a fess nebulée or.*
 CREST. *A peacock's head, erased azure, ducally gorged or.*

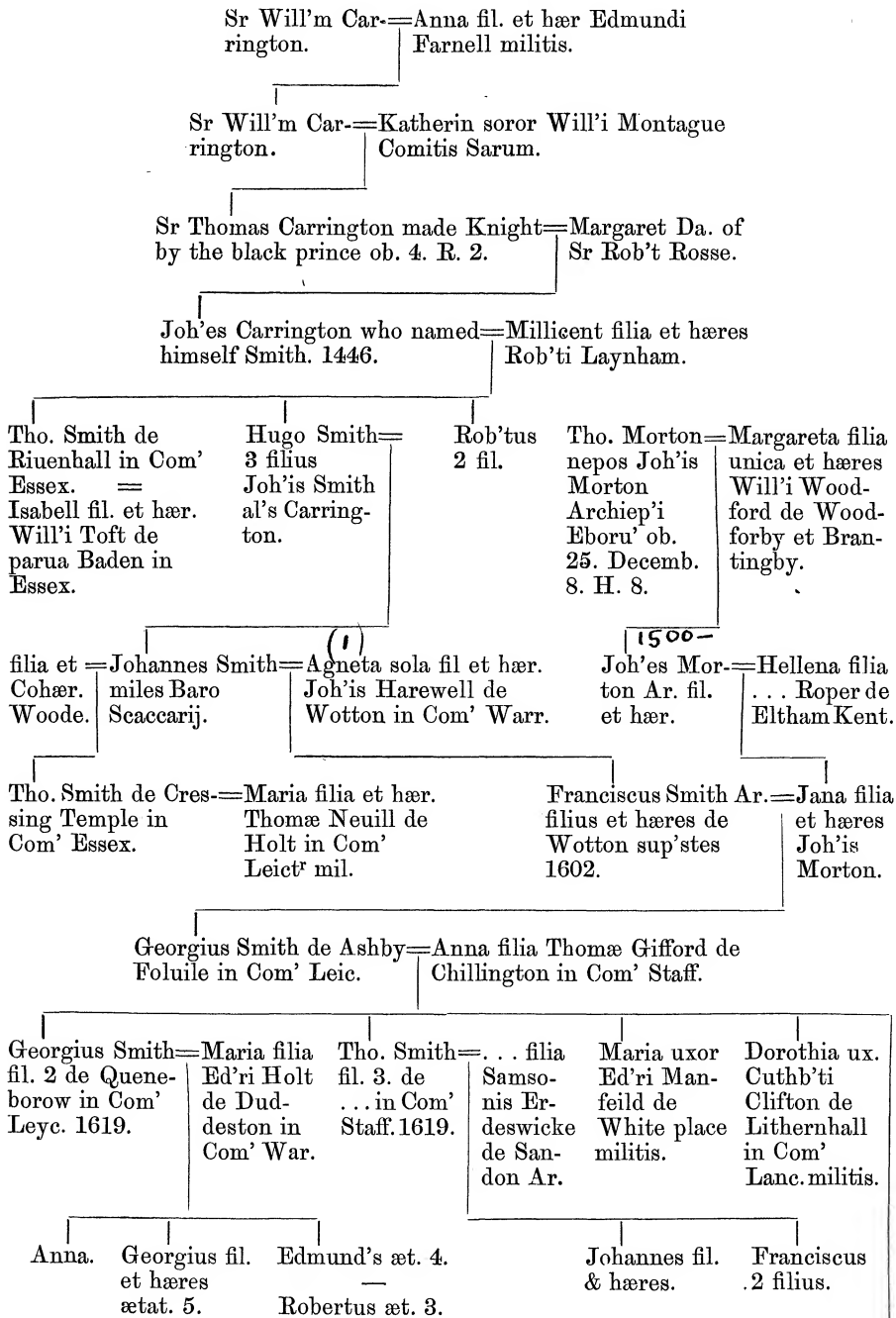

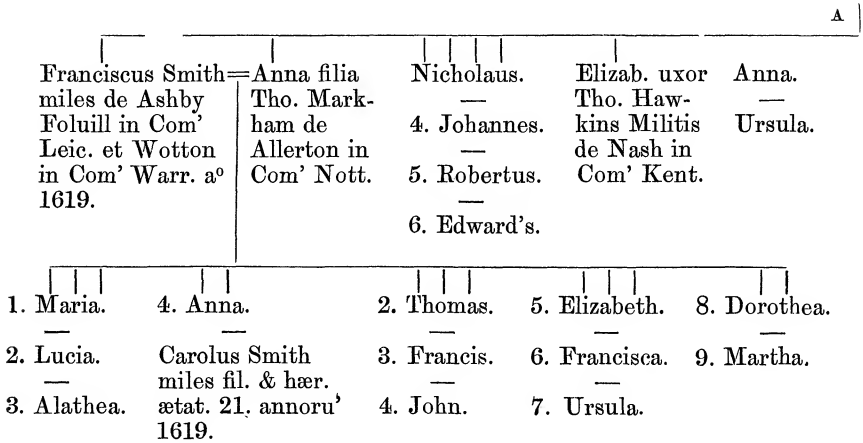

(Ashby.)

ARMS. *Quarterly*:—*Azure, a chevron ermine between three leopard's faces or; and gules, three mallets argent.*

CREST. *Out of a mural coronet argent, a leopard's face or.*

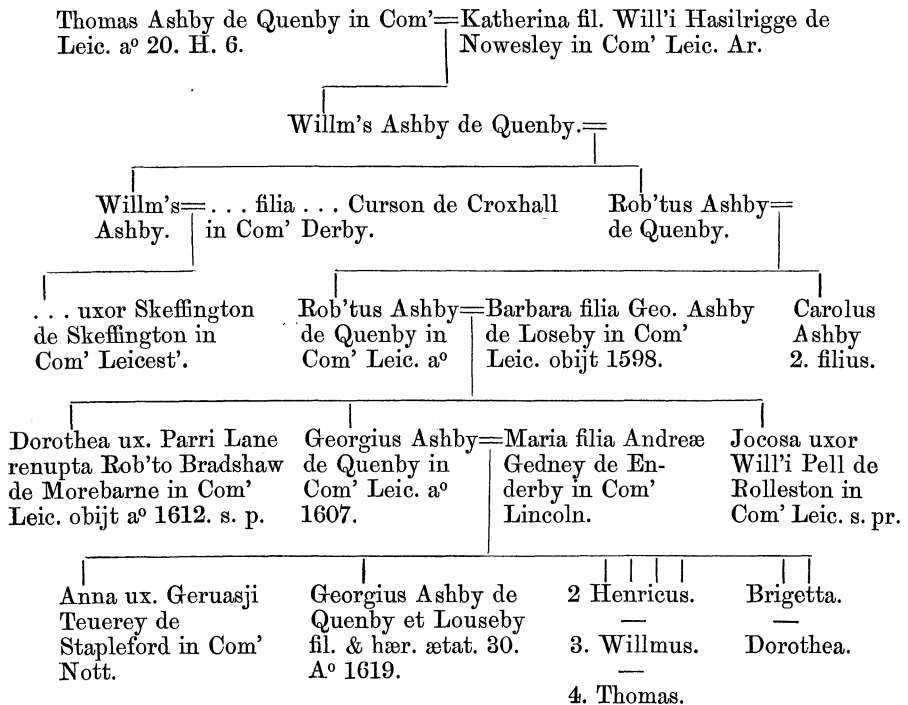

(Cade.)

Henry Cade de Ingarsby son of Brian Cade de=Elizab. fil. Gregorij Isham de
 Insgarsby. 8. son of Rich. Cade of Stanford. | Pitchley in Com' Northamp.

1 Elizab. uxor Tho. Mar- bery de Wardon in Com' Bedf.	2. Euse- buis. — 3. Frän- ciscus.	Brian Cade de= Ingarsby in Com' Leic. miles fil. & heres super- stes 1619.	=Francisca fil. Erasmi Dredon de Cannons Ashby in Com' Northamp. Baronetti.	Margareta ux. Edw. Marberie Clericus. 4 filia.	2 Anna. — 3. Barbara. — 5. Mary.
2. Johannes æt. 7. —	3. Erasmus. —	4. George.	Elizab. fil. 1. ætat. 16.	2 Maria ætat. 14. —	3. Anna ætat. unius anni.

Ex Chartis Ric'i Swynfin de Swynfen in Com' Stafford gen' 14. September. 1619.

H. 5. Henricus dei gra' Rex Angliæ, Franciæ et D'ns Hib'niæ omnibus &c.; Sciatis quod de gra' n'ra sp'iali de assensu D'nor spiritualium et temporalium ac ad requisitionem com'unitatu' regni n'ri Angliæ in parlamento n'ro apud Westm' aº regni n'ri 2º tento existentium pardonauimus et relaxauimus Thomæ Swynfeen alias dicto Thomæ Lichfeld quocunq' nomine censeatur omnimodas transgressiones, offensas, misprisiones, Contemptus et impetic'ones &c. Teste meipso apud Westm' 10 die Aprilis anno regni n'ri quarto.

sub magno sigillo Angliæ.

Irrotulatur in memorand' S'ccarij aº 5. H. 5. inter recorda de termino Paschæ ex parte rememoratoris Thesaurarij.

Sciatis præsentis et futuri quod ego Joh'es de Swynfen d'ns de Swynfen dedi &c D'nis Joh'i Jones et Thomæ de Freford Capellanis, hæredibus et assignatis suis omnia t'ras et ten'ta, prata &c in villis et ham'elettis de Swynfen, Freford, et Whitinton &c Hijs testibus Rad'o de Thikbrom, Henrico Gardiner de Weford, Will'o de Bromley de Whitinton, Thomæ Menell de Hyntes et alijs. Dat. in vigilia natiuitatis S'ci Joh'is Baptistæ aº 43. E. 3.

Charta Joh'is de Swynfen in Swynfen data. aº 49. E. 3.

Ric'us 2. Ricardus dei gra' Rex Angliæ et Franciæ et D'ns Hiberniæ omnibus balliuis &c Sciatis quod pardonauimus Rogero Lichfeld de Wigorn alias dicto Rogero Swynfen omnimoda escapia felonum catalla felonum et fugitiuor' fines amerciamenta &c. Ac insuper cum ad parlamentum n'rum apud Westm' primo die octóbris aº regni n'ri decimo tentum Thomas nuper Dux Glouc' et Ric'us nuper Com' Arundell attrahentes sibi regiam potestatem fieri fecerint quandam Commissionem sub magno sigillo n'ro sibi ipsis et alijs ad eorum denominac'oem directum ad gubernac'oem n'ri et regni n'ri habendam et d'ca commissione usi fuerint iurisdictionem regiam inde super eos capientes quæ quidem Commissio præiudicialis fuit et derogatio nobis et Coronæ n'ræ ac usurpatio n'ræ regaliæ et regie potestatis, et super hoc præd'ci Dux et Comes eorum iniquum propositum et regiam potestatem Colore, d'ca com'issionis continuantes attraxerint eis Thomam Comitem Warr et ipsi tres insimul manu fortè modo Guerrino cum magna potes-

tate et multitudine lig'or n'ror, insurrexerint, et apud Haringsey et alibi se congregauerint, et sic cum tali vi ad n'ram presentiam in palacio n'ro Westm' venerint &c. Nos Volentes ex regia n'ra benignitate gr'am facere in hac parte pardonauius eidem Rogero factam pacis n'ræ &c occasione d'cæ Com'issionis ac congregac'onis insurrectionis &c Teste meipso apud Westm' 26. octob. aº regni n'ri 22.

Sub magno sigillo Anglia.

Nouerint uniu'si per presentes me Will'um de Lichefeld alias d'cum Will'um Tauerner Armigeru' relaxasse Thomæ de Swynfen de Swynfen totum ius in quodam curtilagio iacente in Frogge Lane &c. Hijs testibus Will'o Newport c'hr Rob'to de Swynfen et Will'o Forster de Strethay et alijs Dat. aº 12. H. 4.

SEAL. *Per chevron, in chief three leopard's faces.*

Legend. SIGILLUM WILLIMI LICHEFELD.

Sciant presentes et futuri quod nos Will'm Swynfen et Alianora uxor mea dedimus Edmundo Crowcest de Ashby de la Zouch omnia t'ras et ten'ta n'ra quæ habemus in villis de Sutton et Cateby et alibi nobis spectantibus in Com' Leic. &c Data aº 16. E. 4.

(Swynfen.)

ARMS. *Per chevron sable and argent, in chief three leopard's faces counterchanged.*
CREST. *A boar's head erased azure, charged with a crescent for difference.*

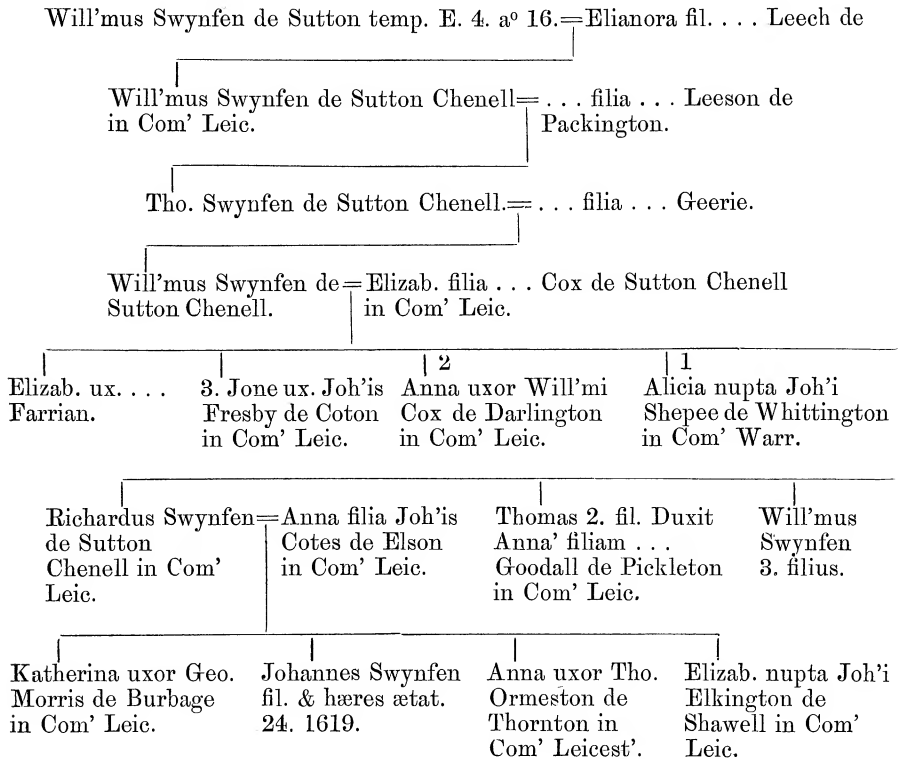

(Wilcocks.)

Rob'tus Nowers de Knossinton in Comitatu Leicestriæ miles.

Rob'tus Nowers, fil. Roberti.

Rad'us Nowers filius Rob'ti filij Rob'ti Nowers militis fuit seiscitus de dineris terris et ten'tis cum pertinent in Knossington al's Cuossing in Com' Leic. in Dm'co suo ut de feodo, et sic inde seiscitus per Cartam suam que Dat est die mercurij in vigilia assentionis aº regni Regis filij regis Ed'ri dedit feoffavit et concessit om'ia præd'ca messuag' terr' et ten't et cetera præmiss' cum pertin'e'n cuidam Will'o Buckland rectori Eccl'ie de Bletherwicke habend' et tenend' &c. Et sic inde seiscitus postea per Cartam suam que dat est pridie Idus feb anno regni Regis Edw. filij regis Ed'ri 12. dedit et concessit om'ia prædicta in'es terras et ten'tes et cetera præmissor' cum pert'nen' præfato Rad'o Nowers et cuidam Margerie filie prædicti Will'i Buckland ad tunc ux'i eiusdam Rad'i habend' et tenend' om'ia prædicta, m'es terras et ten'ta et cetera præmissor' cum pertin' præfato Rad'o et Margerie &c. Et sic inde seiscitus idem Rad'us ob. sine exitu masculo, et habuer' exit' inter eos quendam Margeriam Nowers, Margeria ips'm superuixit et se tenuit intus p' ius heredi' et inde sola fuit seiscit in Dm'co suo ut de feodo, et sic inde seiscit circa annu' 2. regni Regis Ric'i 2. cepit in virum quenda' Will'm Wilcocks al's diet' Hopkins virtute cuius eidem Will's Wilcocks et Margeria inde seiscit fuerunt in Dominico suo ut de feodo, et in iure ipsius Margerie, et sic seiscitus de p'dictis terris et ten'tis habuerunt exitus inter eos quendam Will'm Wilcocks &c. et postea idem Will'm vir ipsius Margerie obiit, post cuius mortem idem Will'm Wilcocks filius prædic' Will'i et Margerie ut fil. et hæres propinquior ip'ius Margerie intrauit in omnia prædic'a præmiss' &c. et sic inde seiscitus obiit post cuius mortem Will'm Wilcocks filius et hæres p'dicti Will'i in prædic'is terris ten'tis cum pertin' intrauit, et inde fuit seiscit &c. et postea sic seiscit', obiit post cuius mortem Rob'tus Wilcocks fil's et hæres prædicti Will'i in om'ia prædic'a messuag' terris et ten'tis cum pertin' intrauit &c. Et sic inde seiscit obiit post mortem cuius Thomas Wilcocks fil. et her. prædicti Rob'ti in om'ibus prædic'is terris et ten'tis cum pertinent' post mortem ip'ius Rob'ti intrauit et inde fuit seisc' &c. Et sic inde seiscit obiit post cuius mortem Rob'tus Wilcocks fil. et her. prædicti Thomæ modo tenens de om'ibus prædic'is &c. Et sil't Comptum est p' eandem evidenc' q'd prædic' ten' et ten't' cum pert'ent tenent' de manerio de Knossington predicto. &c. Et prædic' Rob'tus sic inde seiscit obiit post cuius mortem Rogerus Wilcocks fil. et her. prædicti Rob'ti in om'ibus prædic'is terris et ten'tis intrauit et seiscitus in D'mco suo obiit post cuius mortem Will'm Wilcocks fil. et her. prædicti Rogeri in om'ibus prædic'is terris et ten'tis intrauit, et inde seiscitus in prædic'is terris et ten'tis pro quadam pecunie sum'a Galfrido Wilcocks fratri Juniori præfati Rogeri Auunculo suo per Cartam vendidit qui Galfridus sic inde seiscitus in D'mco suo ut de feodo obiit post cuius mortem Thomas Wilcocks fil. et hæres prædic'i Galfridi intrauit et est modo tenens.

Radulphus de Nowers de Knossington in Com' Leic. 11. E. 2. ARMS. *Per fess chequy or and gules, and ermine.*

Margeria filia Will'mi de Buckland filia et hæres.

Will'mus Wilcocks de Knossington in Com' Leic. Aº 2. R. 2.

Margeria fil. & hæres Radulphi de Nowers

Will'mus Wilcocks de Knossington.

Will'mus Wilcocks fil. et hæres Will'mi.

Rob'tus Wilcocks fil. & hæres Will'mi.

Thomas Wilcocks fil. et hæres Rob'ti.

A

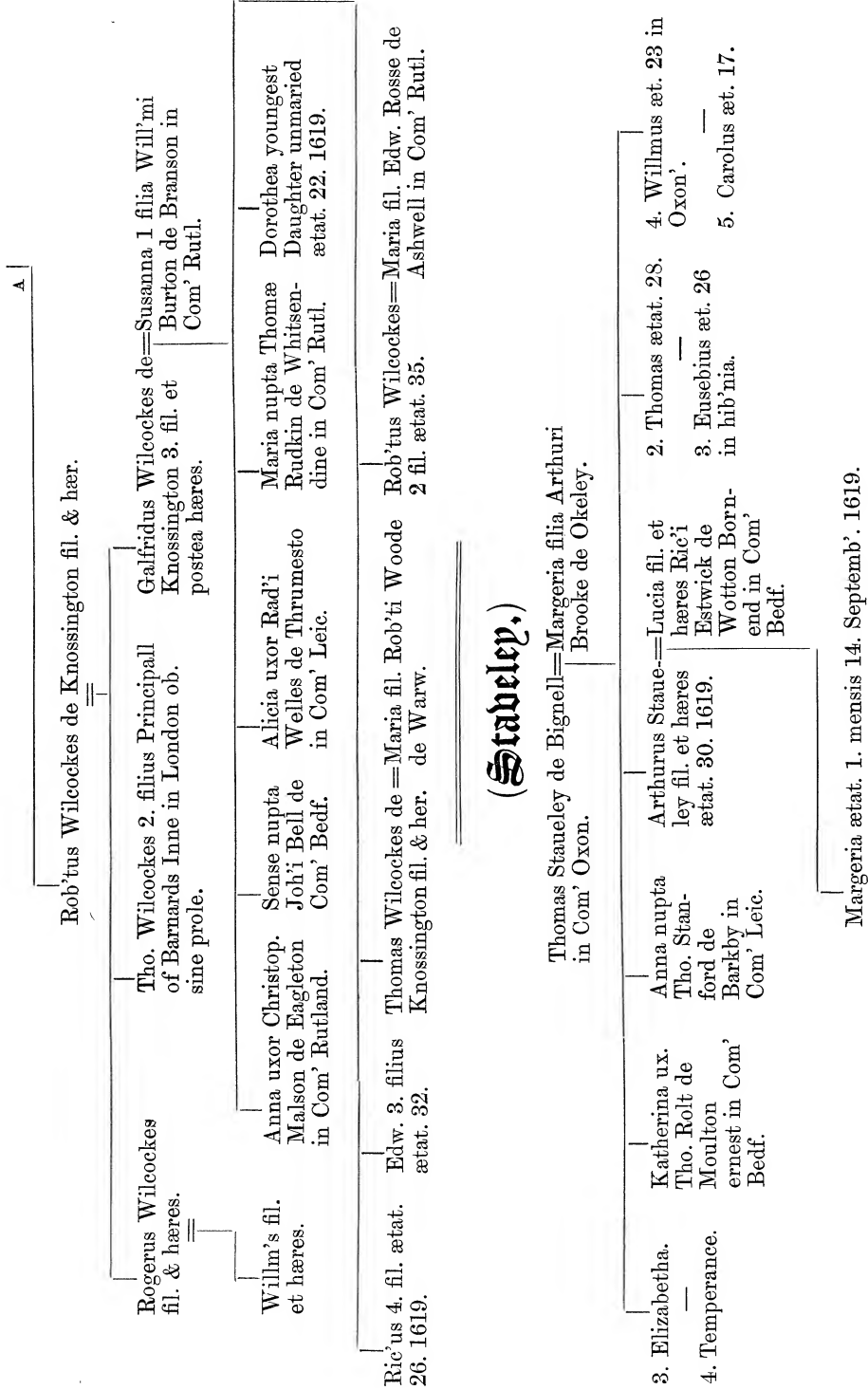

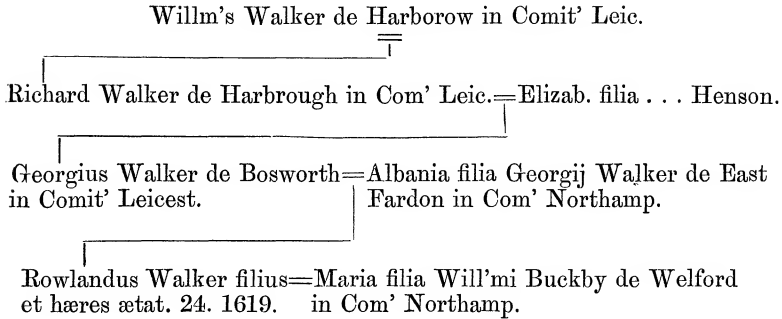
(Walker.)**(Chamberlaine.)**

ARMS. (*Gules*), on a chevron between three escallops (or) a mullet for difference.

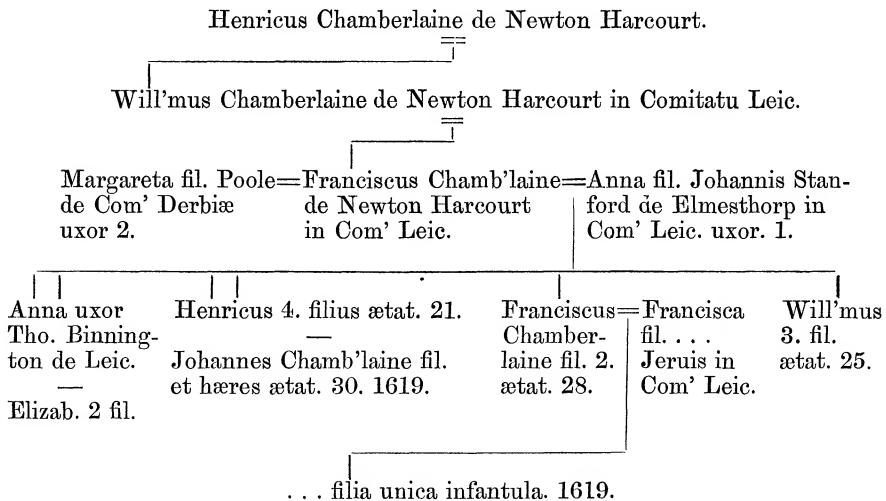

(Cutler.)ARMS. *Argent, three dragons' heads erased gules.*

Arthurus Cutler de Bloherby in Com' Leic. = Margareta filia Henrici Herne.

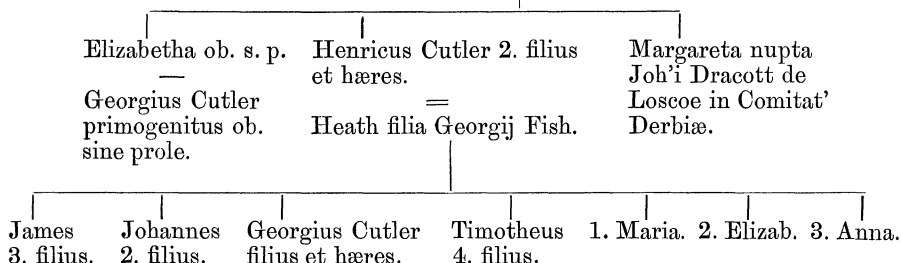
**(Chester.)**ARMS. *Ermine, on a chief sable a griffin passant with wings endorsed argent.*

Willm's Chester de London et Barnett in Com' Hartf.

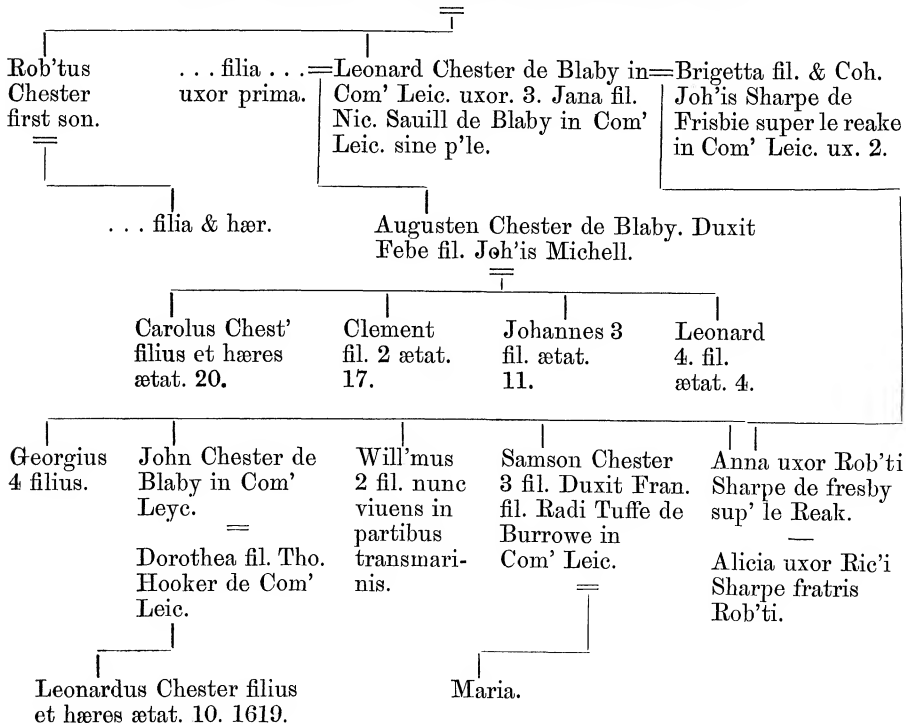

(Grey.)

Edmundus D'ns Grey de Ruthin primus Comes = Katherina filia Hen. de Percy
Cantij creatus a° 5. E. 4. ob. 4. H. 7. Comitis Northumb'.

Anna filia Ric'i Wooduill = Georgius Grey Comes = Katherina filia Will'i Her-
Comitis Riuers relicta Cantij et D'ns Ruthyn bert Com' Pembro' ob. 20.
Wm. Bourchier. ob. 20. H. 7. H. 7. ux. 2.

Ric'us Grey Com' = filia Will'i
Cantij et miles D'ni Hussi.
Garterij ob. 15
H. 8. sine exitu.

Henricus Grey de Wrest = Anna filia
miles frater et hæres Joh'is Bla-
Ric'i Comitis Cantij ob. nerhasset.
1562.

Henricus Grey in Com' Bedford = Margeria fil. Oliuieri D'ni
de Wrest miles. St. John. de Bletzo.

Reginaldus Grey restituitur ad
dignitatem Comitis Cantij p'.
Reg. Elizab. 1571. et ob. 1572.
sine prole.

Henricus Comes Cantij
post fratrem ob. 1612
sine prole.

Carolus Gray
fil. 3. nunc
Comes Cantij
1619. =

Henricus Grey D'ns Ruthin fil. & heres.

Antonius Gray de Branspath = . . . filia Holland.

Georgius Grey fil. & heres = . . . filia Saluaine.

Antonius Grey rector Eccl'ie de Burbach = Magdalena filia Will'i Purifoy de
in Com' Leic. modo sup'stes a° 1619. Caldecot in Com' Warr.

Henricus
Grey fil.
et hæres.
natus 24.
Nouemb.
1594.

- | | | | | |
|----------------|--|--|--|--|
| 2. Johannes. | | | | |
| — | | | | |
| 3. Job. | | | | |
| — | | | | |
| 4. Theophilus. | | | | |
| — | | | | |
| 5. Nathaniell. | | | | |

Gracia uxor Jacobi
Ward alias Farmer
de Hucklescot grang
in Com' Leic.

- | | | | | |
|----------------|--|--|--|--|
| 2. Magdalena. | | | | |
| — | | | | |
| 3. Christiana. | | | | |
| — | | | | |
| 4. Patientia. | | | | |
| — | | | | |
| 5. Priscilla. | | | | |

(Croft.)

ARMS. Quarterly:—1. Lozengy argent and azure. 2. Or, a chevron between three leopards' faces gules. 3. Azure, on two bars or three martlets gules. 4. Or, on two bars gules three water bougets argent, in chief an annulet for difference.

CREST. A wyvern's head couped (untinctured).

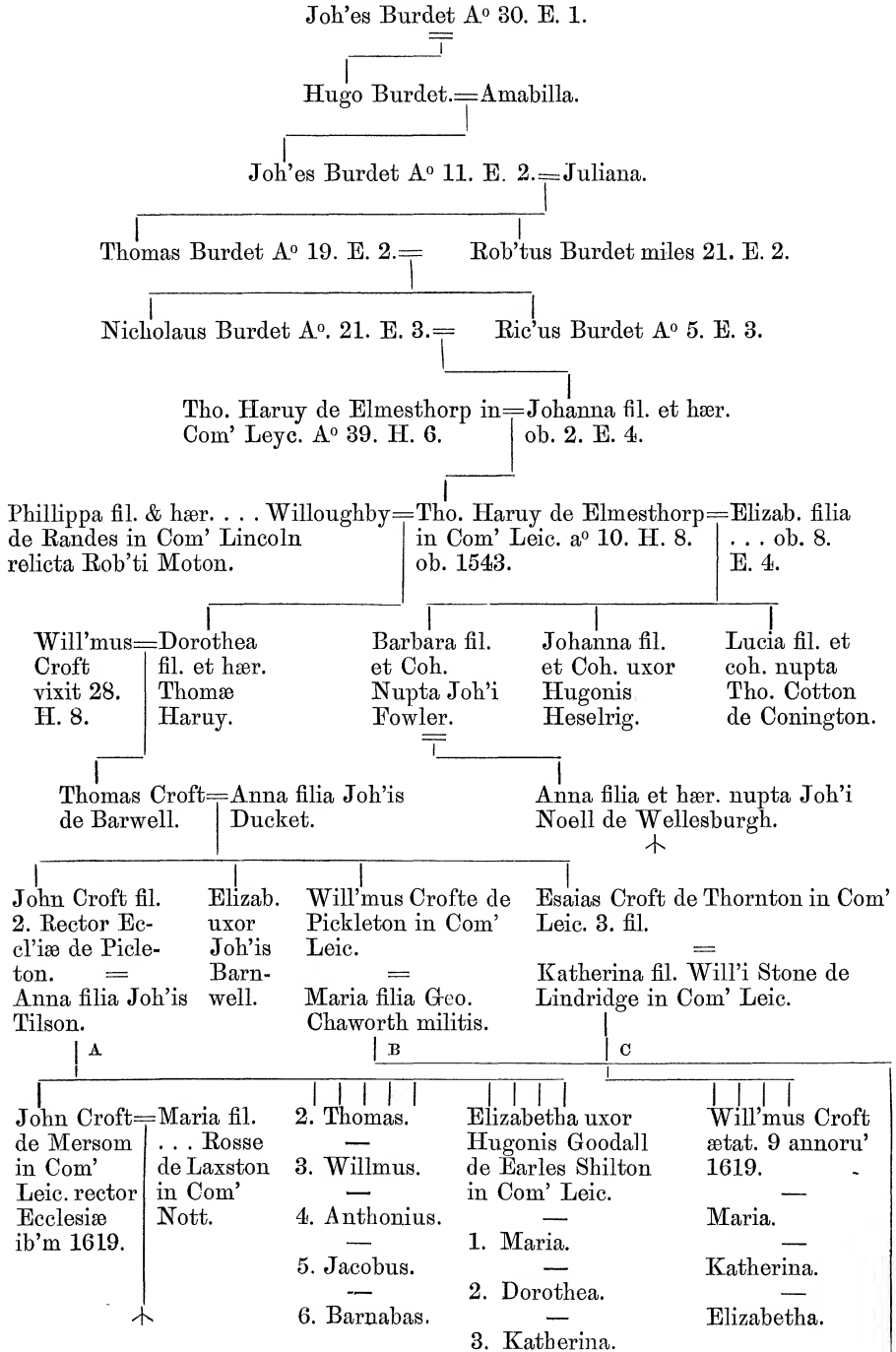

B				
Will'mus Croft fil. primogenitus obiit ante patrem 14 Nouemb' 1612 sine prole.	Thomas Croft de Pickleton in Com' Leic. iam sup'stes 1619.	= Susanna filia Tho. Wright de Snelson in Com' Darb.	Dorothea ux. Tho. Wightman de Hinkley in Com' Leic.	Gracia uxor Tho. Auerey de Fleckney in Com' Leic. clerici.
Anna uxor. Hen. Meade de Narborow in Com' Leic.	Maria uxor Ric'i Burdet de Mousley in Com' Leic.	Elizab. uxor Hugonis Goodall de Shilton in Com' Leic.	Georgius. — Georgius.	Henricus. — Katherina sine prole.

(Bale.)

ARMS. *Quarterly* :—*Per pale vert and gules, an eagle displayed argent, armed or; and azure, three spears in bend argent, staffs or.*

CREST. *A demi-lion rampant, couped gules, grasping the handle of a broken spear erect or.*

Signed by W^m Segar Garter to S^r John Bale of Curlew.

Joh'es Bale de Carlton Curlew in Com' Leic.

=					
Joh'es Bale de Carlton Curlew in Com' Leic. s. p.	= Johanna filia . . . Pettie.		Rob'tus Bale de Carleton Curlew filius 2.	= Joanna fil. . . Gamble de Burton Ouerey in Com' Leic.	
Edwardus Bale filius primogenit's s. p.	Joh'es Bale de Carleton Curlew et Sadington in Com' Leic. miles iam sup'stes. 1619.	= Francisca filia Barnardi Brocas de Com' South.		Katherina ux. Tho. Sanderson de Wheston in Com' Leic.	
Edmundus Bale de Sadington in Com' Leic. fil. 5. 1619.	= Jocosa filia Ric'i Robertes de Sutton Chenell in Com' Leic.		Franciscus Bale de London Marcator. fil. 4. a ^o 1619.	= Margareta fil. Joh'is Manning de London mercatoris. fil. 3.	
1 Elizabetha.	3. Dorothea.	Will'mus Bale filius 1. ætat. 9. annorum.	2 Johannes.	Anthonium Bale filius et hæres.	Filia.
2. Francisca.	4. Jocosa.		3. Ricardus.		
Georgius Bale de Carlton in Com' Leic. fil. primogenitus.	= Elizab. filia Valentini Hartop de Burton Lazars in Com' Leic.		Rob'tus Bale de Carlton in Com' Leic. 2 filius s. p.	= Alicia filia . . . Couper de Thromaston in Com' Leic.	
A					

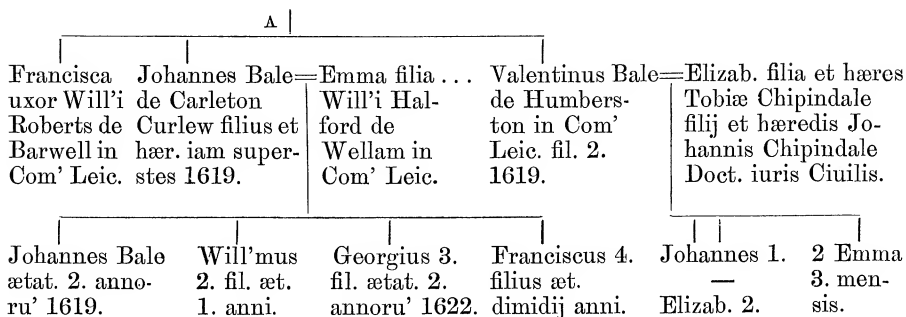

(Eberard.)

ARMS. *Quarterly*:—1. *Gules, on a fess between three étoiles argent as many mullets sable.* 2. *Argent, on a chief sable three mullets of the field within a bordure of the second bezantée.* 3. *Argent, on a fess between three bears' heads erased sable, muzzled or, as many bezants.*

CREST. *A man's head couped at the shoulders proper, crined sable, having on his head a cap or, charged with three bars wavy of the second.*

Rob'tus Euerard de Shenton in Com' Leic. =Margareta filia Tho. Woluerston de Wood in Com' Staff.

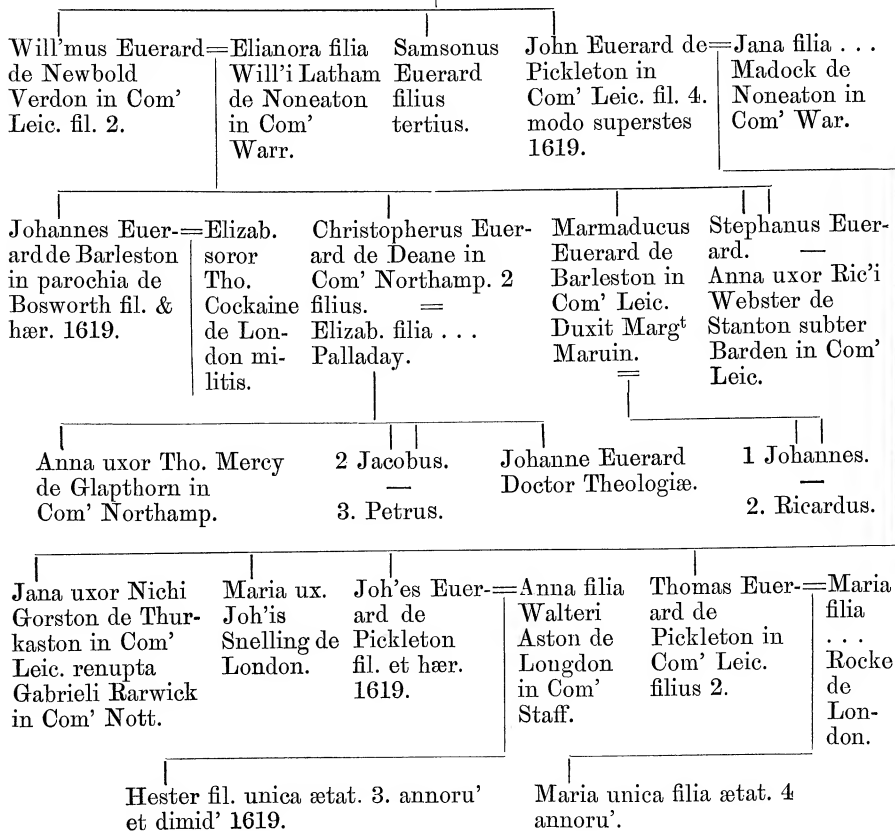

(Brudnell.)

ARMS. *Quarterly* :—1. *Argent, a chevron gules between three morions azure.* 2. *Ermine, on a chevron gules three escallops argent.* 3. *Gyronny of eight or and sable.* 4. *Azure, a bend cotised between six cross crosslets fitchée or.* 5. *Sable, a stag's head caboshed argent, attired or, between the attires a cross pattée fitchée of the last, in its mouth an arrow barwise azure, barbed of the second.* 6. *Paly of six argent and azure, on a chief sable two swords in saltire of the first, hilted and pomelled or.* 7. *Sable, three fusils in fess argent.* 8. *Argent, on a bend engrailed sable three mullets of the field.*

CRESTS. *First. A sea-horse with tail nowed, charged on the breast with a crescent for difference (untinctured).* *Second. A talbot statant, ducally gorged (untinctured).* *Third. An arm coupéd at the shoulder, embowed vert, the hand proper, holding a spiked club with sling attached or.*

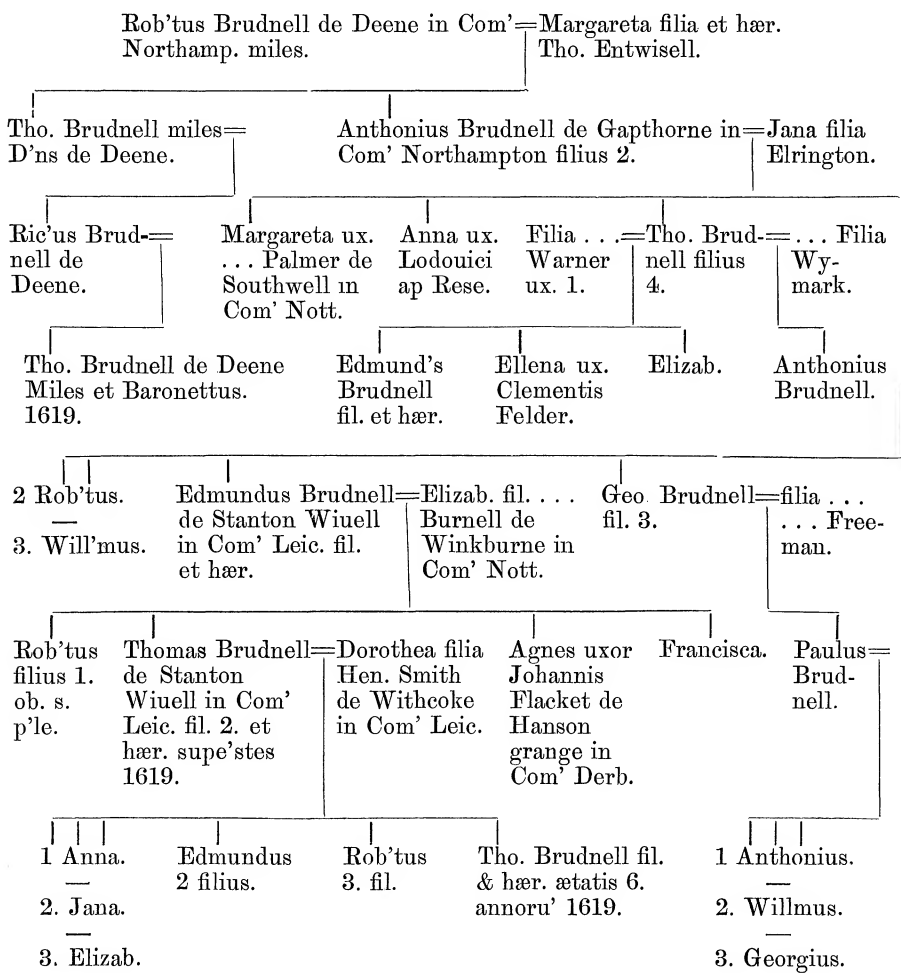

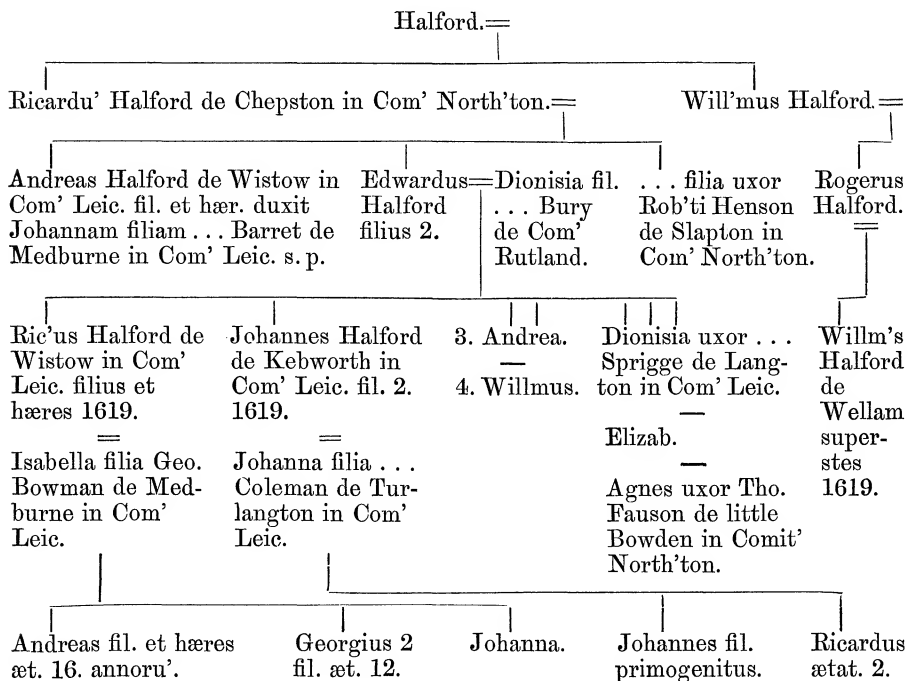
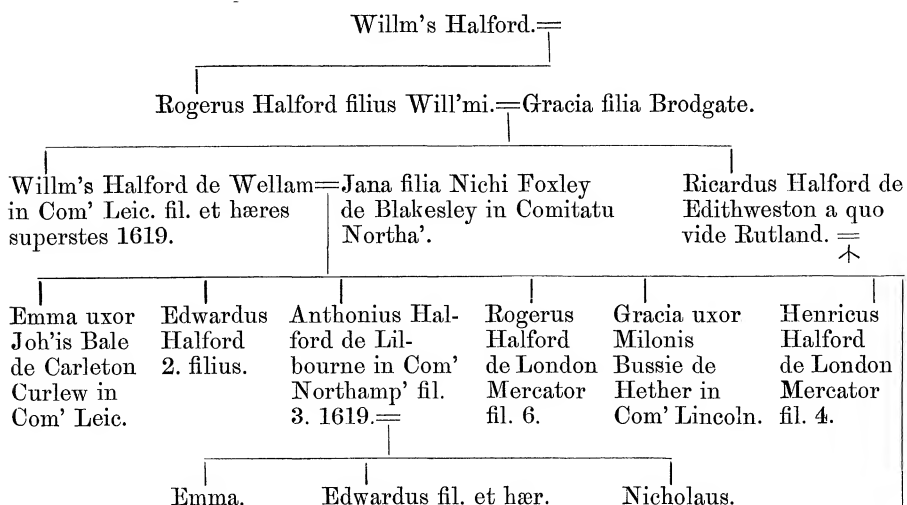
(Halford.)**(Halford.)**

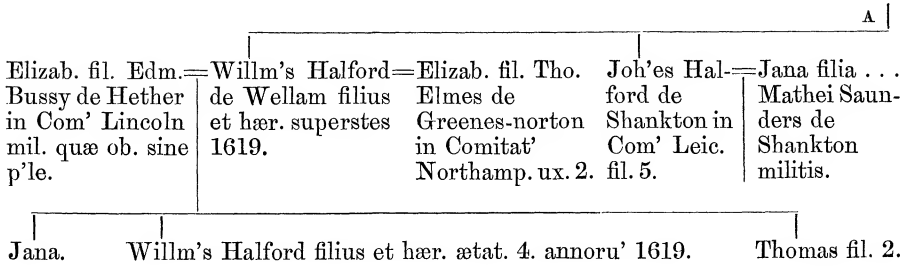

(Carrington alias Smith.)

ARMS. *Quarterly*.—1. *Argent, a cross gules between four peacocks azure.* 2. *Quarterly argent and sable, in the first quarter a fleur-de-lis gules, and in the fourth an ermine spot.* 3. *Gules, a saltire ermine.* 4. *Lozengy or and gules, on a canton per pale (untinctured) a . . . ?* 5. *Gules, billetée a lion rampant or.* 6. *Bendy of six, over all a chevron (untinctured).* 7. *Or, two bars nebulée sable, a canton ermine.* 8. *Azure, a fleur-de-lis ermine.* 9. *Bendy of six gules and vert, a chevron ermine.* 10. *Bendy of six or and azure, a canton ermine.* 11. *Or, a chevron gules, a chief indented vert.* 12. *Lozengy or and sable.*

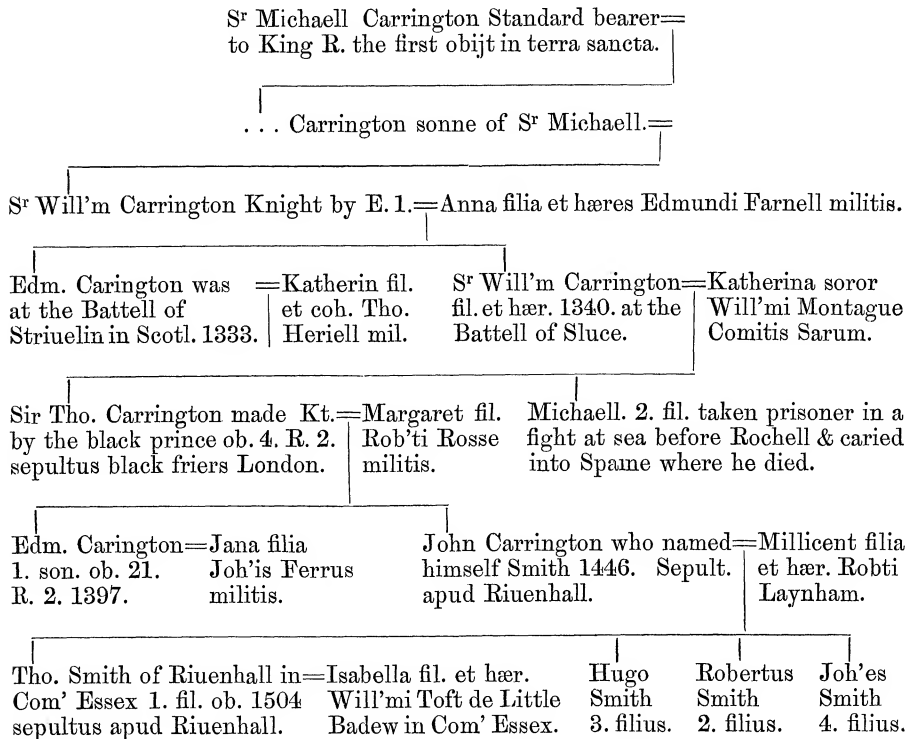

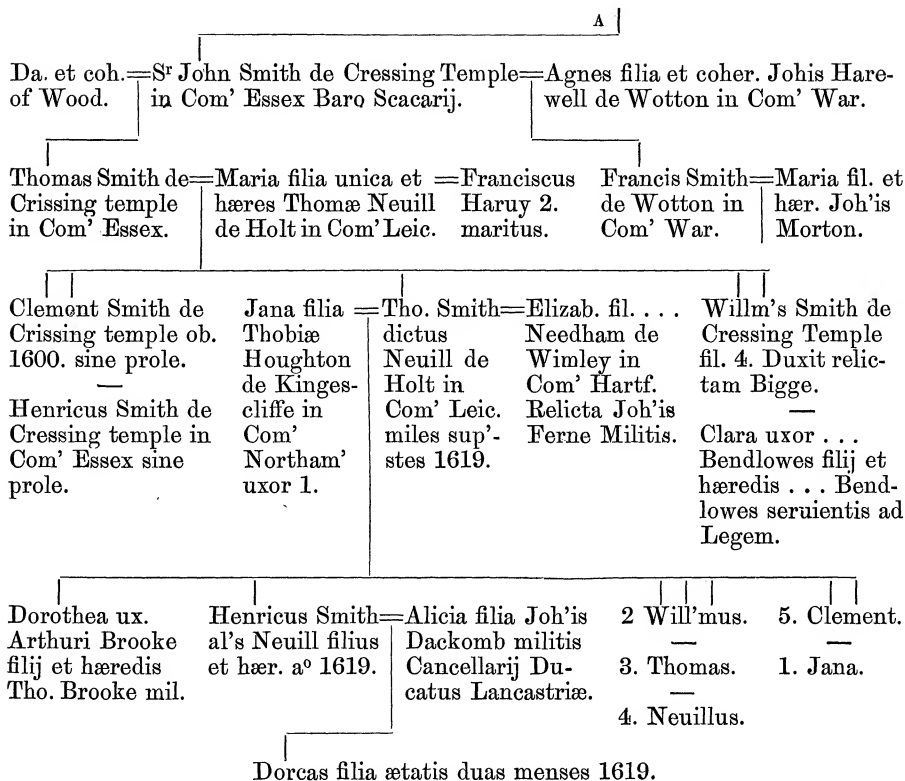

(Peck.)

ARMS. Quarterly:—*Argent, on a chevron engrailed gules three crosses pattée of the field; and gules, a cross flory or, on a chief azure three round buckles of the second, in dexter chief a mullet for difference.*

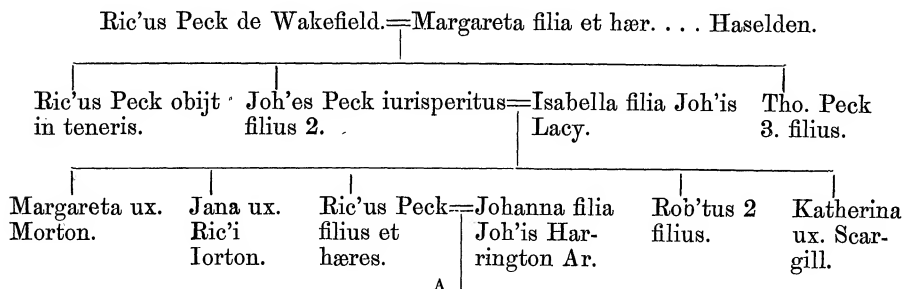

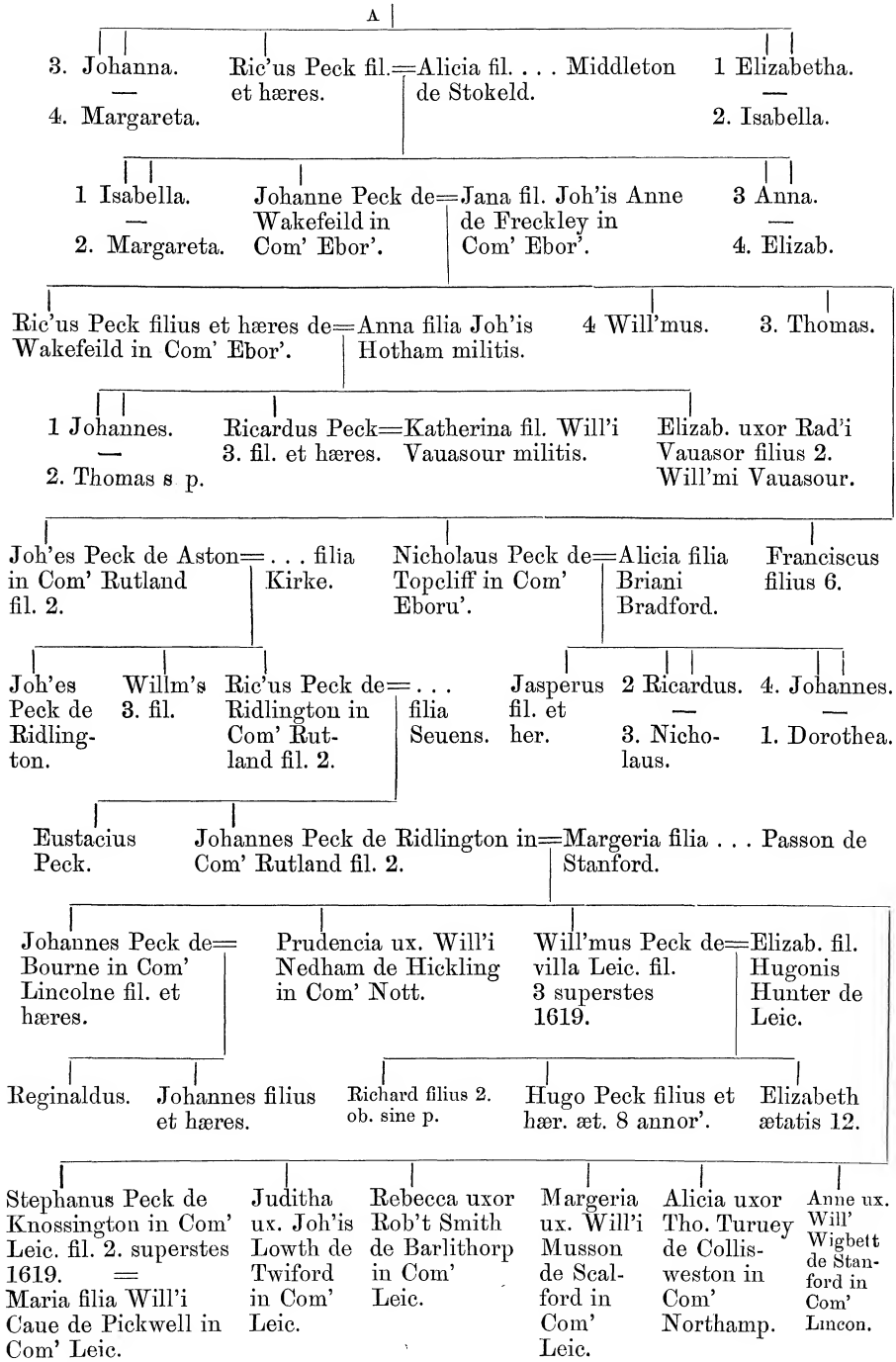

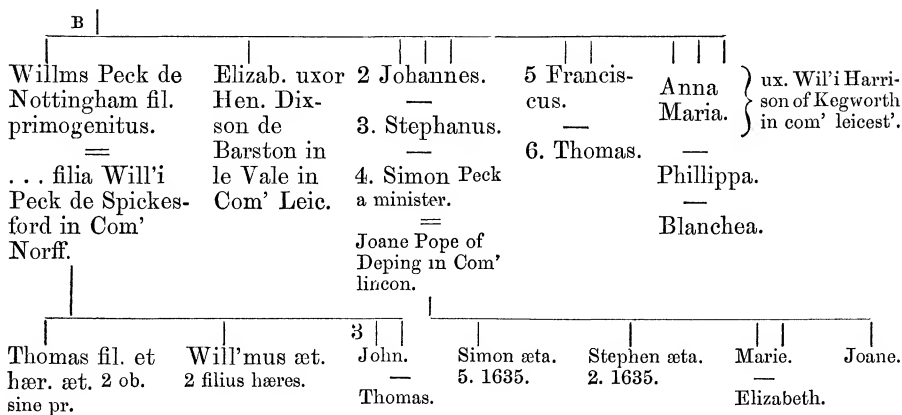

(Whalley.)

ARMS. *Argent, three whales' heads erased sable.*

CREST. *A whale's head erased sable.*

=Rob'tus Whalley de Bunney in Com' Nott.=

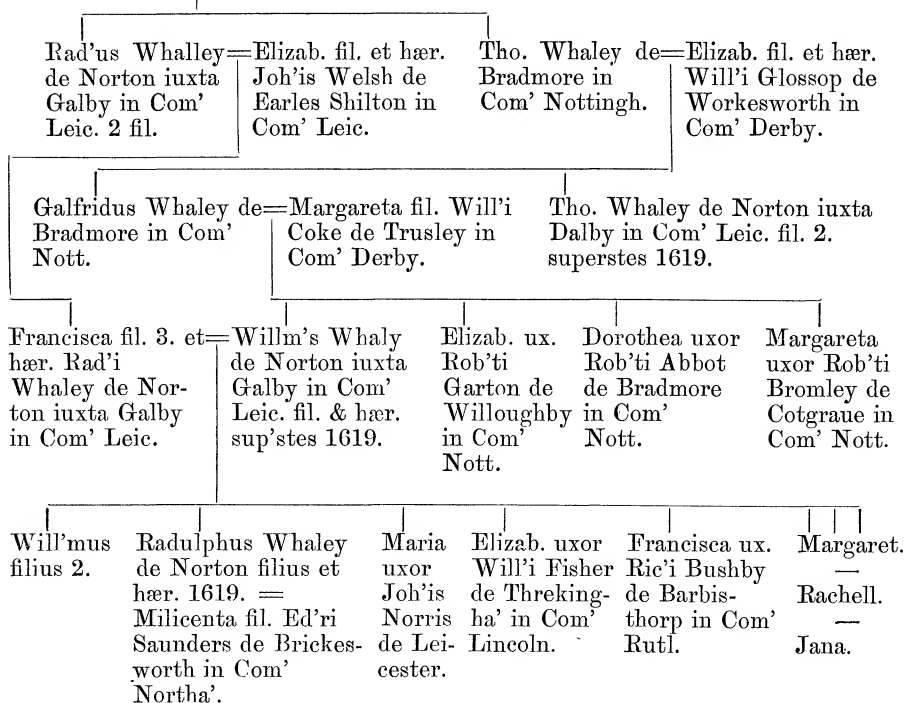

(Fox.)

ARMS. *Argent, on a chevron between three foxes' head erased gules, a mullet for difference.*

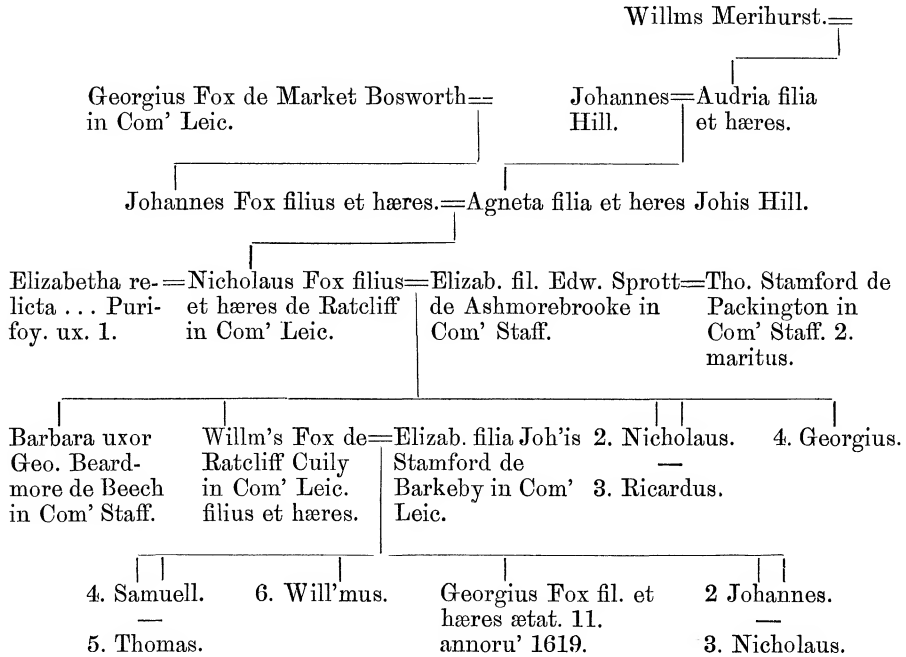

(Cradock.)

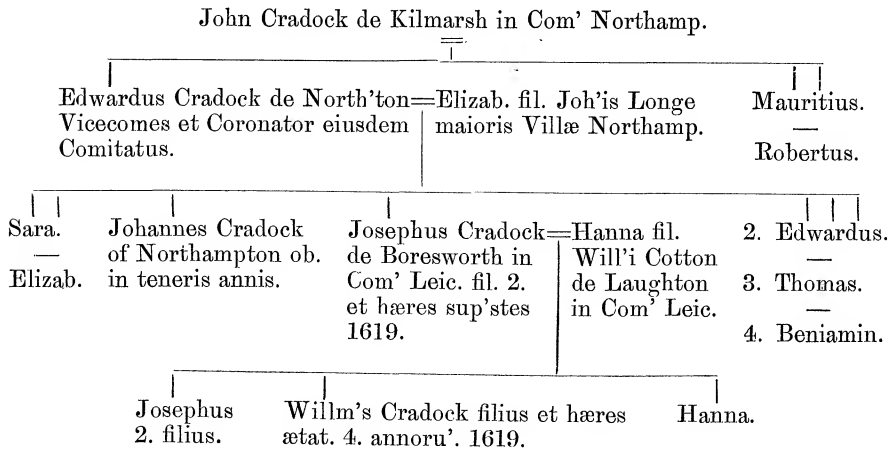

(Bankes.)

Henricus Octavus dei gra'. Angliæ, Franciæ et Hib'niæ Rex &c. Omnibus &c. Sciatis quod dedimus et concessimus dilecto seruieto n'ro Will'mo Bankes locum siue officium unius vibrellatoru' n'ror' infra Turrim n'ram London, et ulterius dedimus præfato Will'o pro exercitio officij præd'ci vad' et feodum sex denariorum sterlingoru' per diem &c. Habend' pro vita &c. Teste meipso apud Westm' nono die Februarij anno regni n'ri tricesimo quarto.

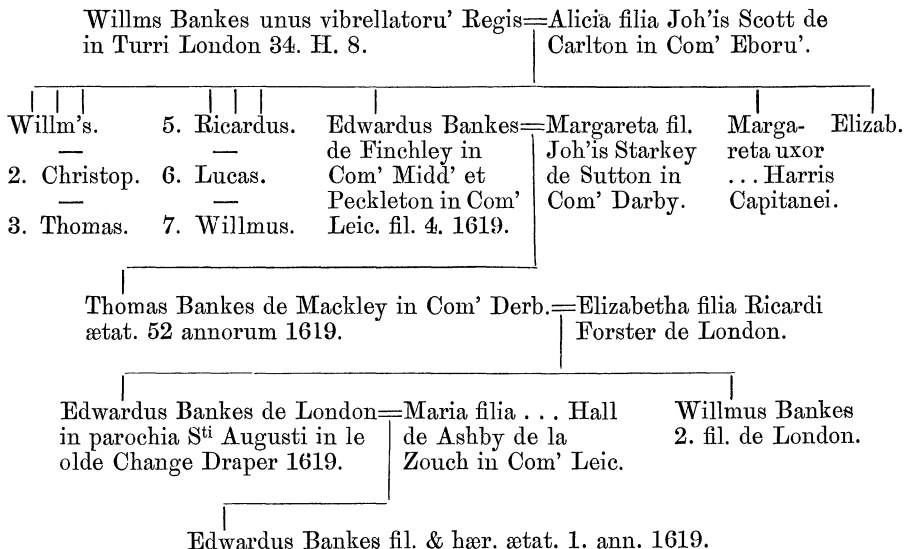
**(Baghot.)**

ARMS. *Ermine, on a bend gules three eagles displayed or, in chief a martlet for difference; impating vert, a chevron between three eagles displayed crowned or.*
CREST. *A stag's head caboshed sable, between the attires a greyhound courant argent, collared gules.*

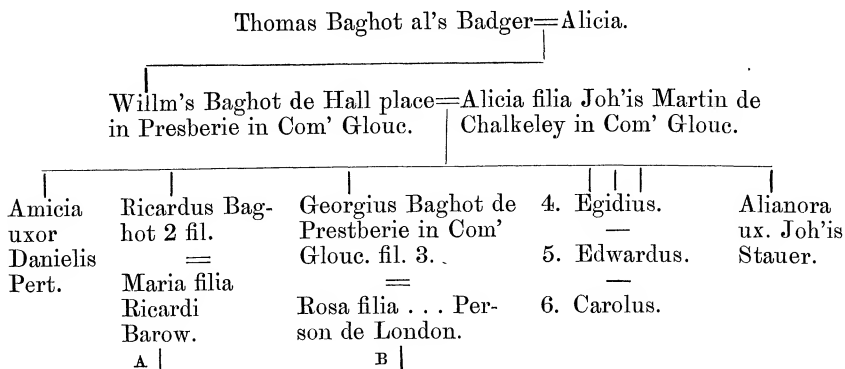

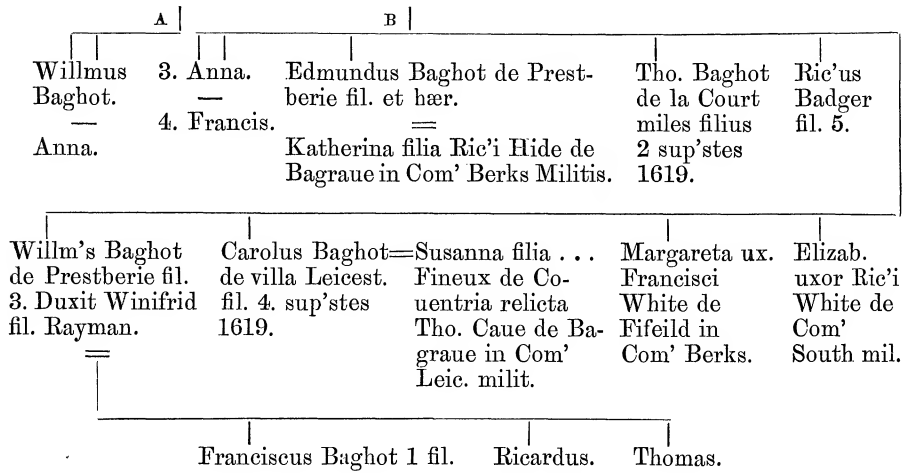

(Meade.)

ARMS. *Sable, a chevron between three pelicans with wings endorsed vulning themselves or.*

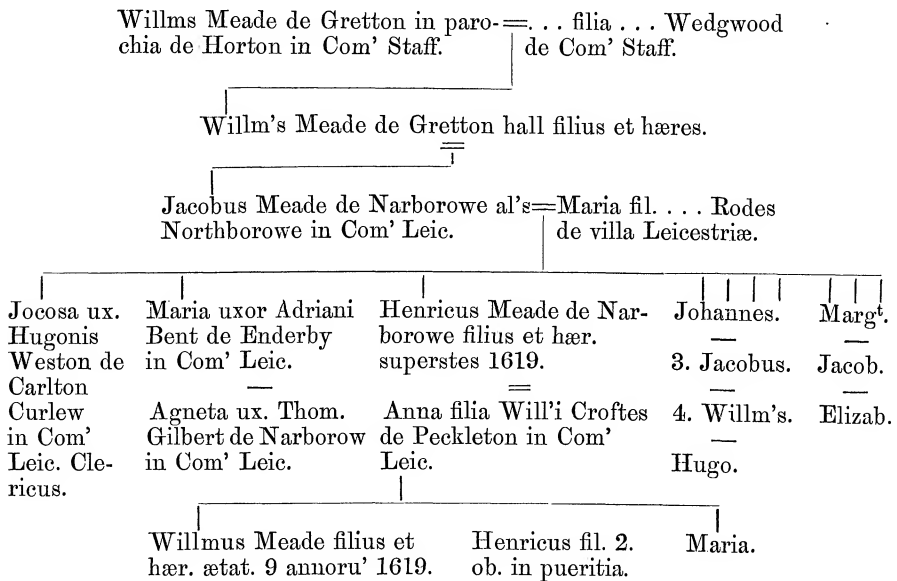

(Cowper.)

ARMS. *Argent, on a bend engrailed between two lions rampant sable three plates.*

CREST. *A cockatrice's head erased argent pelletée, beaked combed and wattled gules.*

Thomas Cowper de Arthingworth = Susanna soror Pinchpooli
in Com' Northamp. Clericus in Louet de Weston iuxta
artibus magist' Weedon in Com' Northamp.

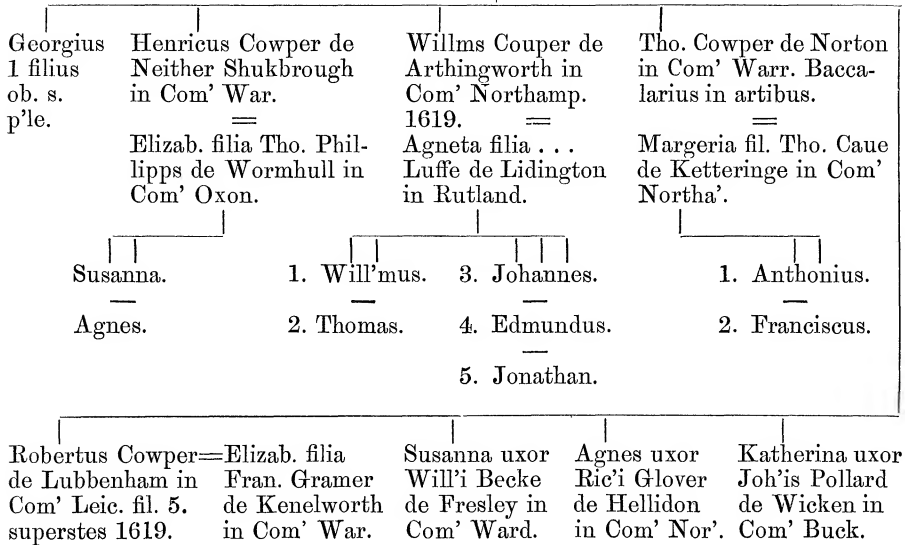
**(Wright.)**

Rogerus Wright de Sutton in Com' Leic.

Willm's Wright de Sutton in Com' Leic.

Tho. Wright de Sutton = . . . filia Broadgate de Peatling
in Com' Leic. parua in Com' Leic.

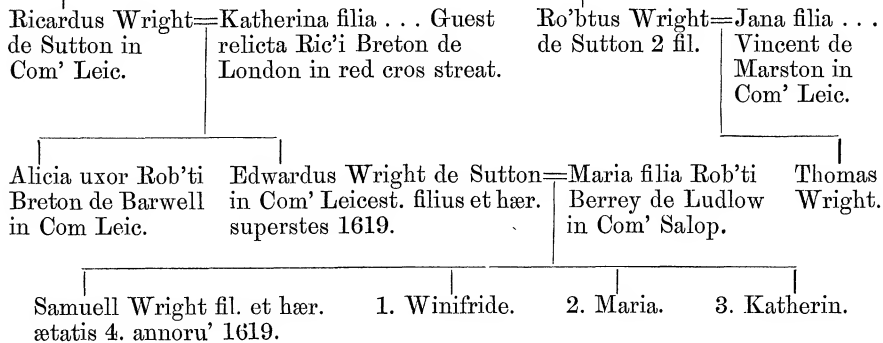

(Abney.)

ARMS. *Or, on a chief gules a lion passant argent.*

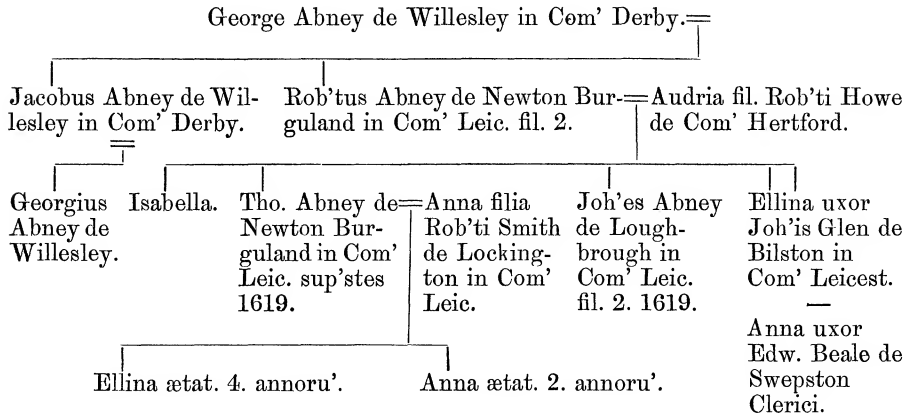

(Elkington.)

ARMS. *Gules, six cross crosslets or, three in chief and three in base, between two faunches argent.*

CREST. *Out of a mural coronet chequy or and sable, embattled of the first, a demi-griffin ségreant argent, winged gules, holding in the dexter foot a gold ring, gem of the second.*

To Tho. Elkington of London Gent son of Humphrie Elkington son of Richard Elkington, son of Richard Elkington of Shawell in Com' Leic. Gent. Descended from y^e family of Elkington of Elkington in Com' Northt. & confirmed to the said Thom. & his Uncles Hen. Thomas & Edw. Elkington & their issues 22. Octob' 1608. 6. Jacobi p' W^m Camden Clarenceux.

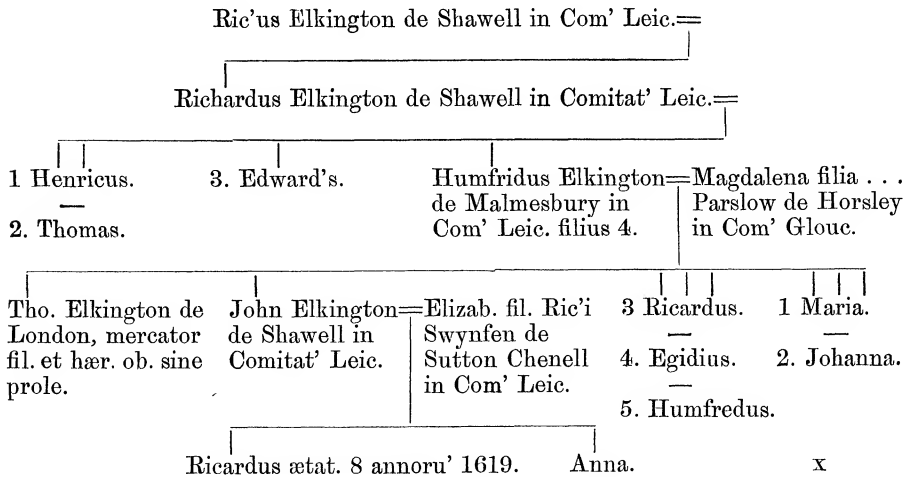

(Abney.)

ARMS. *Or, on a chief gules a lion passant argent, a mullet for difference.*

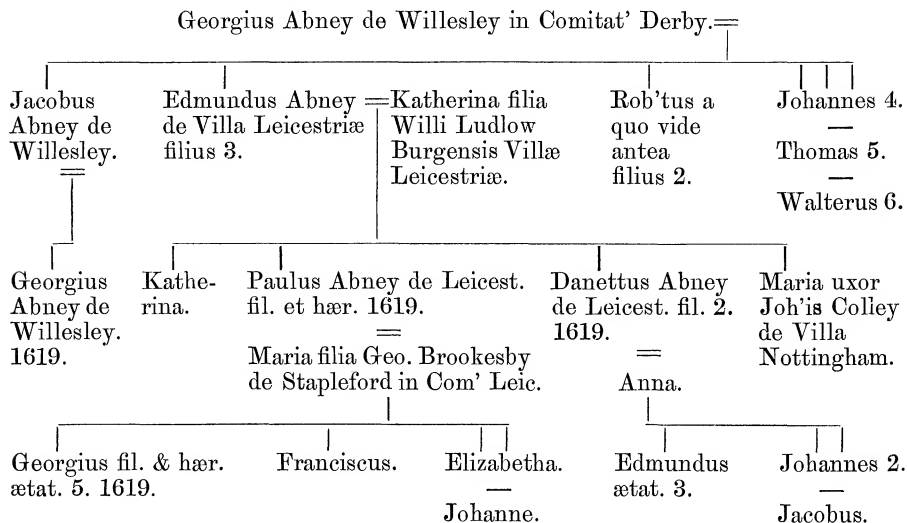

Sciant præsentēs et futuri quod ego Joh'es filius Ric'i filij Nigelli de Abkettleby dedi et concessi Hugoni Bernard de Abkettleby &c. Hijs testibus Will'o de Londam, Johe Cl'ico, Henrico de Crucem Ric'o Repin & alijs.

(Hodges.)

ARMS. *Gules, a chevron ermine between three talbots' heads or, each issuing out of a mural coronet azure, in chief a mullet for difference.*

CREST. *A talbot's head couped or, guttée-de-sang, collared and ringed gules.*

MOTTO. *Fundamentum Gloriæ humilitas.*

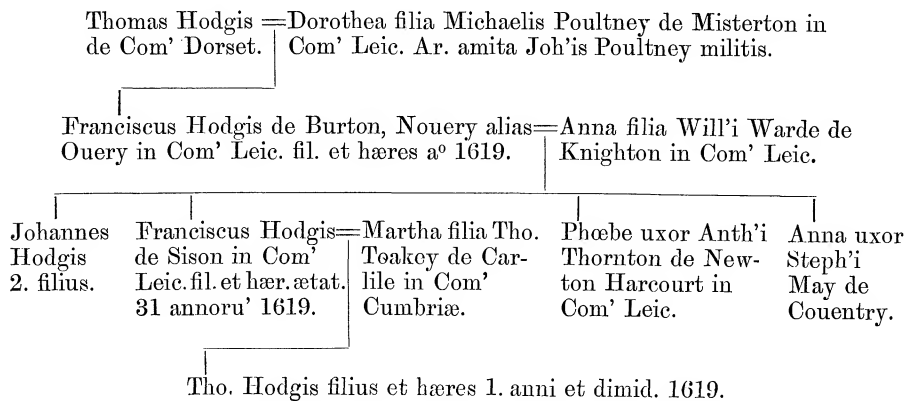

(Lascelles.)

ARMS. *Quarterly* :—1. *Argent, three garlands gules.* 2. *Azure, on two bars or, six martlets gules.* 3. *Argent, a chevron between three talbots' heads erased gules.*
 CREST. *Out of a ducal coronet or, a griffin's head vert, beaked of the first.*

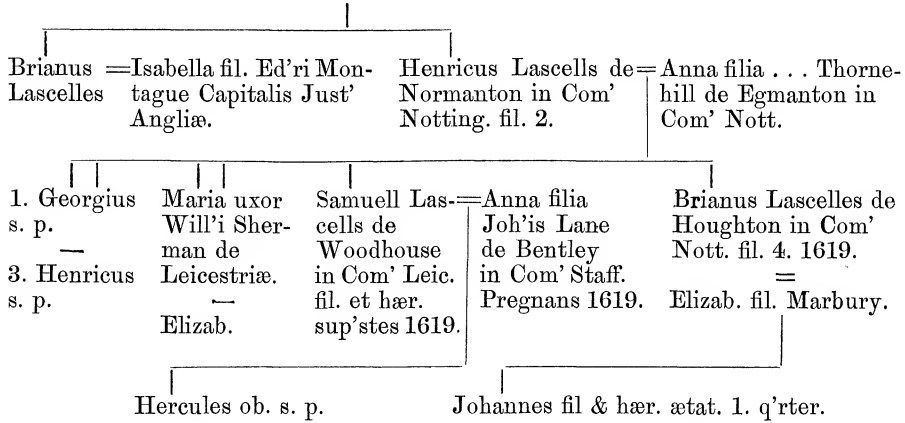

(Mulsho.)

Edwardus Mulsho de Borow in Com' Leic. = Maria filia Hen. Borowe in Com' Leic.

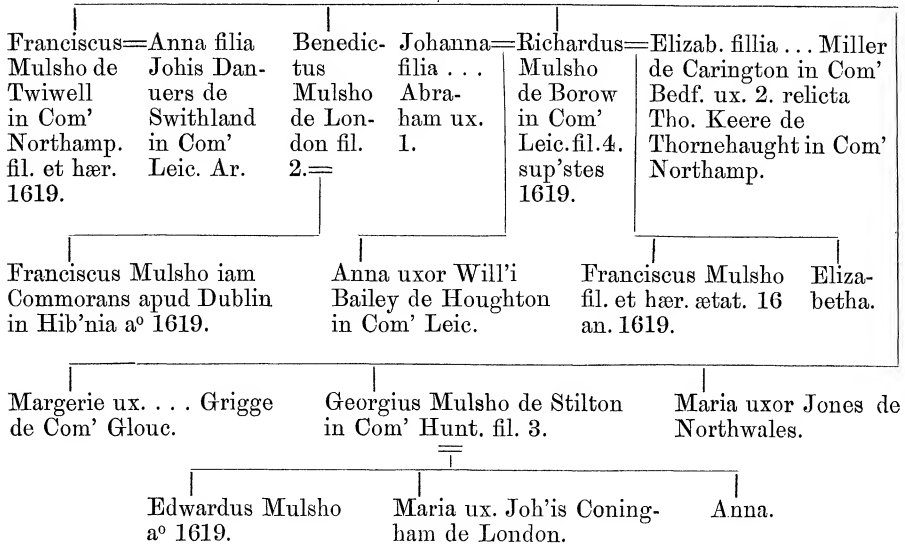

(Wincoll.)

ARMS. *Ermine, a chevron quarterly per chevron or and sable, between three crescents gules.*

CREST. *An arm couped at the shoulder, embowed and erect from the elbow in armour, holding a spear (untinctured).*

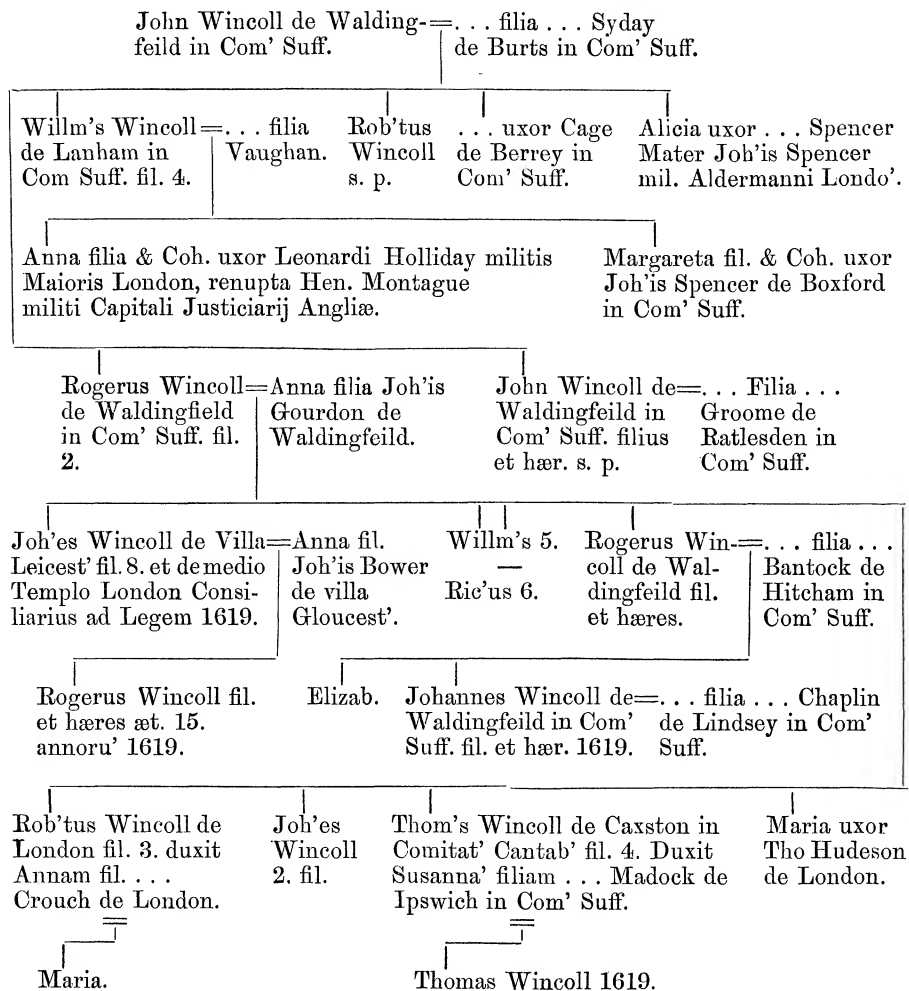

(Chippingdale.)

ARMS. *Azure, semée of fleur-de-lis or, two lions' gambes erect and erased paleways argent.*

CREST. *A lion's gamb erect argent, erased gules, grasping a fleur-de-lis or.*

Giuen by Sr Will'm Dethick Garter 16. May. 36. Eliz. 1594.

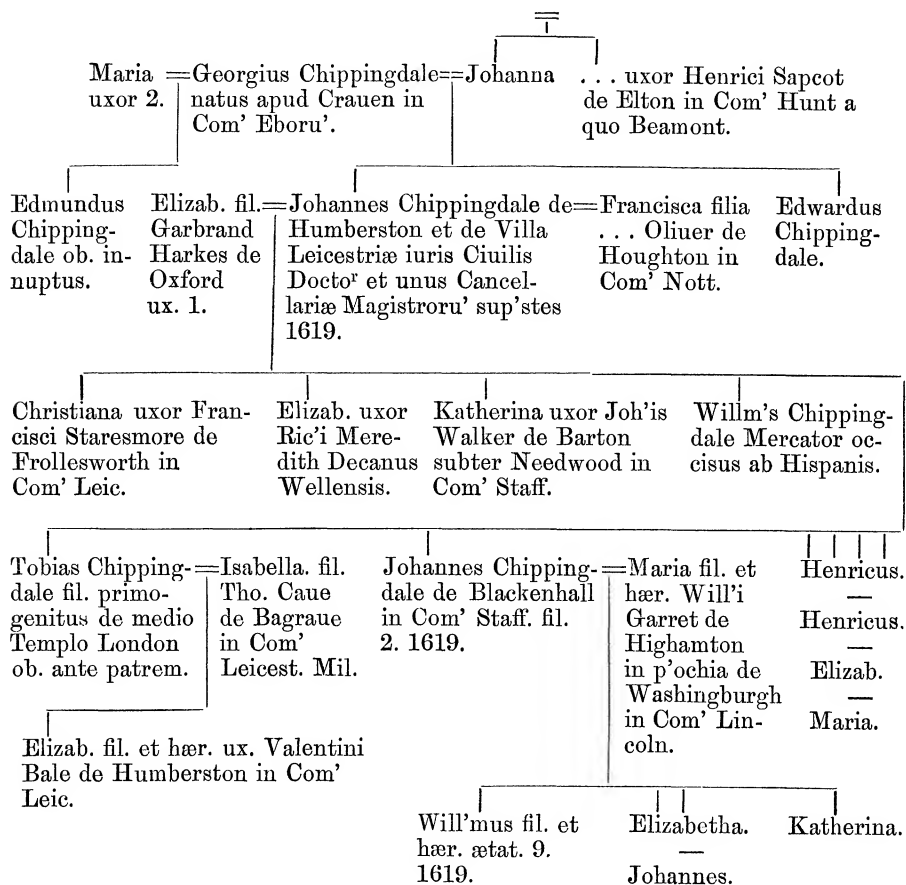

(Bent.)

Thomas Bent de Enderby in Com' Leic. = Alicia filia . . . Willmer de Enderby.

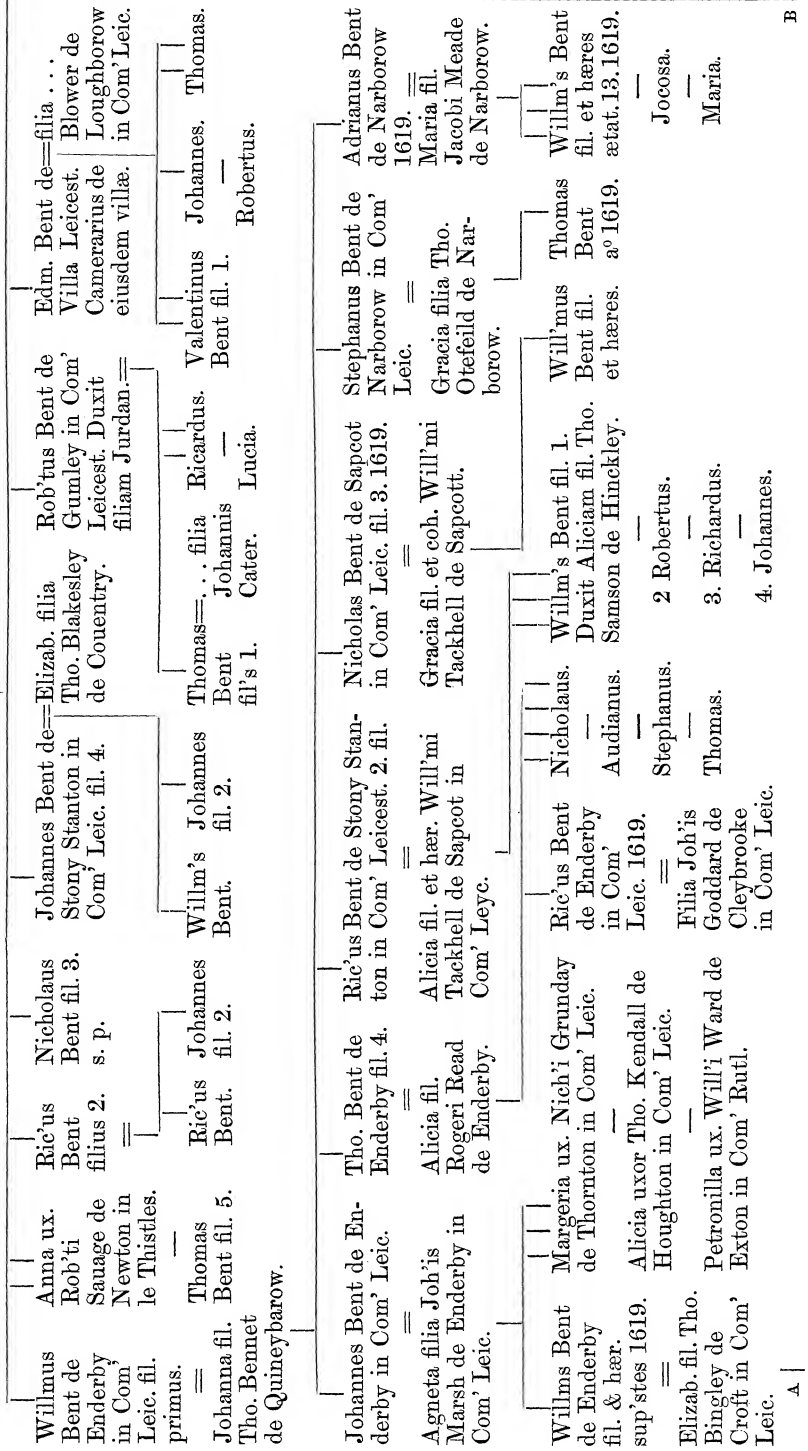

B

A |

A

1 Johannes. 4. Johannes ob. s. p. Josephus ætat. 8. 1619. Willm's 3. fl. ætat. 6. Maria. Anna. Ellena. Brigetta. Elizab. s. p.

Rogerus Bent de Frollesworth in Com' Leic. filius ætate minimus=Agneta filia et hæ. Will'mi Clarke de Frollesworth.

Margareta ux. Ric'i Perkins Ursula ux. Tho. Hewett de Margeria ux. Tho. Fletcher de Georgius. Willm's Bent de Billesdon in Com' Leic. fl. et hæ. sup'stes 1619.
 de Copston in Com' War. Strettaston in Com' Wor. Leicester. Ambrosius ob. s. p.
 Elizab. ux. Nich'i Smith de Alicia ux. John Champion Goditha ux. Hugonis Lowe Anna fl. Rob'ti Parkenall de Barwell in Com' Leic. de Kirkeby Monachous in de Billesdon in Com' Leic. Glaston in Com' Rutl.

Will'm Bent de Cosby in Com' Leic.=

Thomas Bent de Cosby in Com' Leic.=

Joh'is Bent de Cosby=Elizab. filia Ric'us Bent de=Amicia fl. Tho. Bent de Cosby Willm's Bent de Cosby duxit Rob'tus Bent de filius 1. ob. s. p. ... Walton. Cosby. fl. 2. ... Jay. in Com' Leic. fl. 3. fl. Gunston filius 4. Cosby fl. 5.

... ux. Thomas Parker. Elizab. uxor Willi Ward. Richard. Joh'es Bent de Cosby Duxit Ricardus. 3. Thomas. Agnes uxor Willi Estwell. Alicia uxor Ric'i Miles. Thomas. Maria' filia Berrey. 4. Willms 1619.

1. Ricardus. Ricardus Bent fl.=Anna fl. Will'i Morton Thomas 4. Alicia ux. Joh'is Freeman de Cosby Elizab. 2. Johannes sine p'le. Archidia. Noui Castri super Tynan. Willm's 5. in Com' Leic. Maria.

Willm's ætat. 1. anni et dimid. 1619.

B

(Stanford.)

ARMS. *Argent, three bars azure, on a canton or a fess, and in chief three mascles sable, in chief a mullet charged with a mullet for difference.*

CREST. *A dexter gauntlet in bend or, grasping a broken sword erect argent, hilted and pomelled sable.*

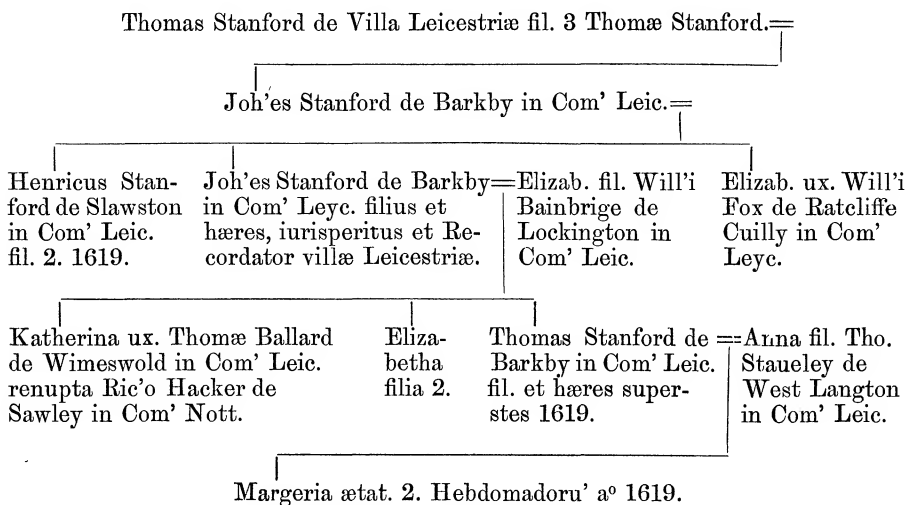
**(Burton.)**

ARMS. *Sable, a chevron between three owls argent, crowned or.*

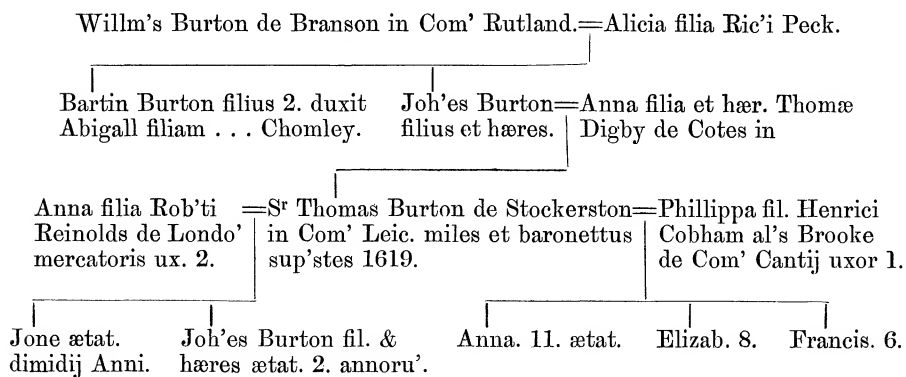

(Breton.)

ARMS. *Azure, on a bend between six stars pierced or, in dexter chief a mullet for difference.*

CREST. *A lion's gamb erased erect azure, charged with a chevron or, between six billets argent.*

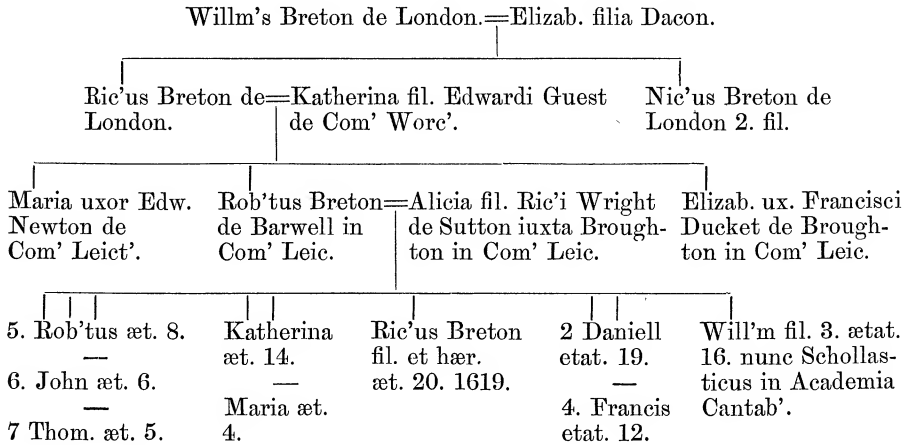

(Bradshaw.)

ARMS. *Argent, two bends between two martlets sable.*

CREST. *On a mount a stag statant, under a vine-tree, all proper.*

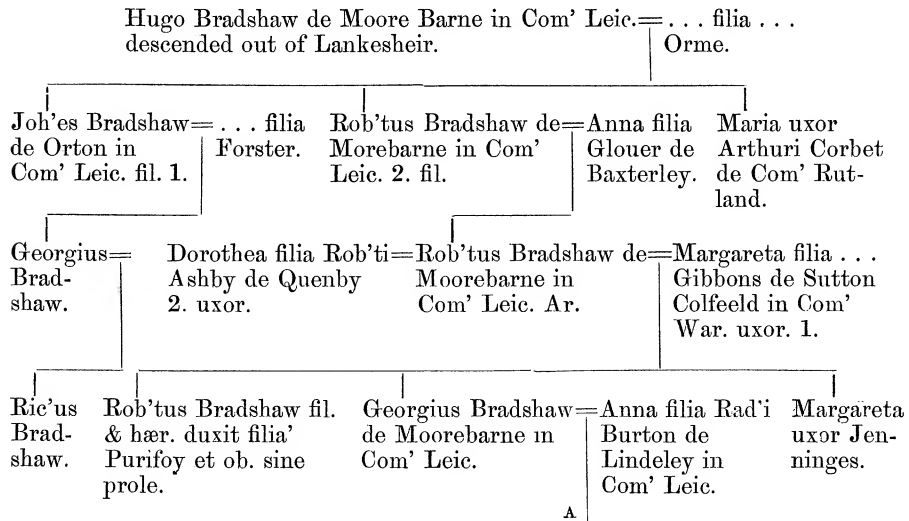

A

Y

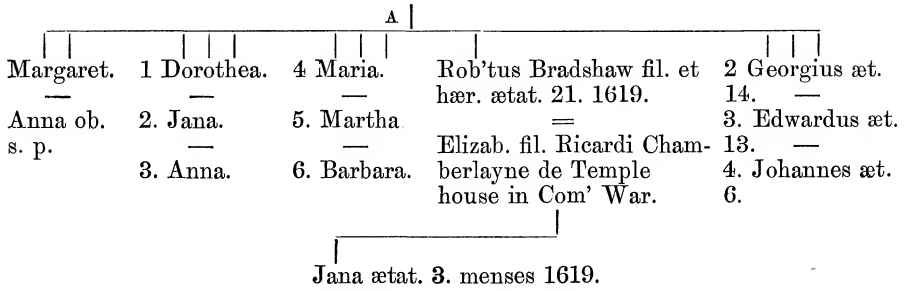

Sciant præsentēs et futuri quod ego Joh'es, filius Ric'i filij Nigelli de Abkettleby dedi et concessi Hugoni Bernard de Abkettleby et Elenæ filiæ eius et hæredibus d'ei Hugonis de corpore suo Legitime procreatis quatuor acras t'ræ cum pertinentijs in Campis de Abkettleby, quarum una roda iacet &c. Hijs testibus Will'o de Loudham, Joh'e Cl'ico Henrico ad Crucem, Ric'o Repin, Will'o de Lenton et alijs. Dat' apud Abkettleby die omniu' Scantorum a^o regni regis Edw. 1. tricesimo primo.

Alia Charta eiusdem Joh'is filij Ric'i, filij Nigelli de Abkettleby Data a^o 32. E. primi.

Sciant præsent' et futuri q^d ego Joh'es filius Henrici Atte Crosse de Abkettleby dedi concessi et hac præsentī Carta mea Confirmaui Ric'o Neale de Abkettleby tres acras et dimid' terræ arrab' cum pertinentijs in Abkettleby &c. dedi etiam eidem Ric'o om'ia bona mea mobilia et immobilia in prædictis tribus acris terræ et dimid' existent'. In cuius rei testimonium præsentibus sigillu' meum apposui. Hijs testibus &c. Dat' apud Abkettleby die Sabbathi prox' post festu' S'ci Mich'is Ap'li A^o regni regis Ed. tertij post conquestu' 2.

Sciant præsentēs et futuri q^d ego Willm's Neele de Abkettleby dedi Concessi et hac præsentī Carta mea Confirmaui Joh'i Neele de Melton Mowbray et Robto Kirketon de Thornton super Wale Capellano omnia terras, ten'ta et rditus mea cum edificiis, pratīs, et pasturis cum om'ibus suis pertinent' &c. In cuius rei testimonium sigillu' meum apposui. Hijs testibus Will'o Latham Ric'o Rinell, Joh'i de Ripon, Will'o Spencer, Ric'o de Holwell, et alijs. Dat' apud Abkettleby die dominica prox' post festu' S'cæ Luciae virginis Anno regni regis Ed'ri tercij post conquestum Angliæ quadragesimo sc'do.

Sciant præsent' et futuri q^d ego Willm's de Latton Capellanus didi Concessi et hac præsentī Carta mea confirmaui Joh'i filio Willm'i Neele de Abkettleby &c. In cuius rei testimonium huic præsentī Cartæ sigillum meum apposui. Hijs testibus Will'o Neele, Will'o Lawrence Joh'i de Thorpe et alijs. Dat' apud Abkettleby die martis in festo Sti Lawrenceij martiris anno regni Regis Ric'i secundi post Conquestu' tertio decimo.

Sciant præsent' et futuri q^d nos Will'mus Bollers Capellanus et Thomas Michelson de Guipton dedimus, concessimus et hac præsentī Carta n'ra confirmaui Will'o Neele filio Joh'is Neele de Abkettleby illud Capitale mesuagium in Abkettleby cum tribus bouatis terræ, q^d quidem messuagium cum præd'cis tribus bouatis terræ ha'mus ex dono et concessione prædic' Joh'is Neele quondam patris præd'ci Will'mi Neele habend' et tenend' prædictu' messuagium cum præd'cis tribus bouatis terræ præfato Will'o Neele et hæredibus de se legitime procreatis &c. In cuius rei testimonium &c. Hijs testibus &c. Dat' apud Abkettleby in festo Seacti Jeronimi A^o regni regis Henrici quarti a conquesto quinto.

Hac Indentura testatur q^d ego Joh'es Neele de Abkettleby feoffauit Guill'm Bellers Capellanu' et Tho. Michelson hæredes et assignatos suos in feodo simplici, in om'ibus t'ris et ten'tis suis in Abkettleby et Holwell cum om'ibus pertinent' suis &c. Conditio istius feoffamenti talis est q^d præd'cus Tho. et Willm's refoffauerunt prædictu' Joh'em Neell, et heredes et executores suos si superstes sit &c.

Et si contingit q'd præd'c'm Joh'em Neale obiire, refeoffament' d'caru' terraru' q'd p'd'es Willm's et Tho. feoffauerunt Will'm filium præd'ci Joh'is Neell sibi et hæredibus de se legittime procreatis. Et si contingat præd'cum Will'm sine hærede de se legittime procreat obiire q'd prædicta terra et ten'ta Johannæ Sorori suæ uxori Ric'i Prate &c. In cuius rei testimoniu' &c. Dat' apud Abkettle in festo Apostoloru' Phillippi et Jacobi anno regni regis. H. 4. post Conquestu' 4.

Nouerint uniu'si per p'ntes me Thomam Spicer de Hesell in Com' Eboru' remisisse, relaxasse et omnino pro me hæred' et executores meos imperpetuu' quietu' clamasse Will'o Neele de Abkettleby in Com' Leic. & Sigillo meo Sigillat. dat. 2. die Junij anno regni Regis Hen. sexti post conq. vicesimo secundo.

Nouerint uniu'si p' p'ntes me Joh'em Derby filiu' et hæredem Will'i Derby Junioris remisisse relaxasse et omnino pro me et hæredibus meis imperpetuu' quietu' clamasse Will'o Neele totu' ius et clameam &c. In cuius rei testimoniu' &c. Dat. apud Abkettleby in festo translationis Sti Thomæ martiris A° Regni Edw. 4 post conq' Angliæ tertio.

(Neale.)

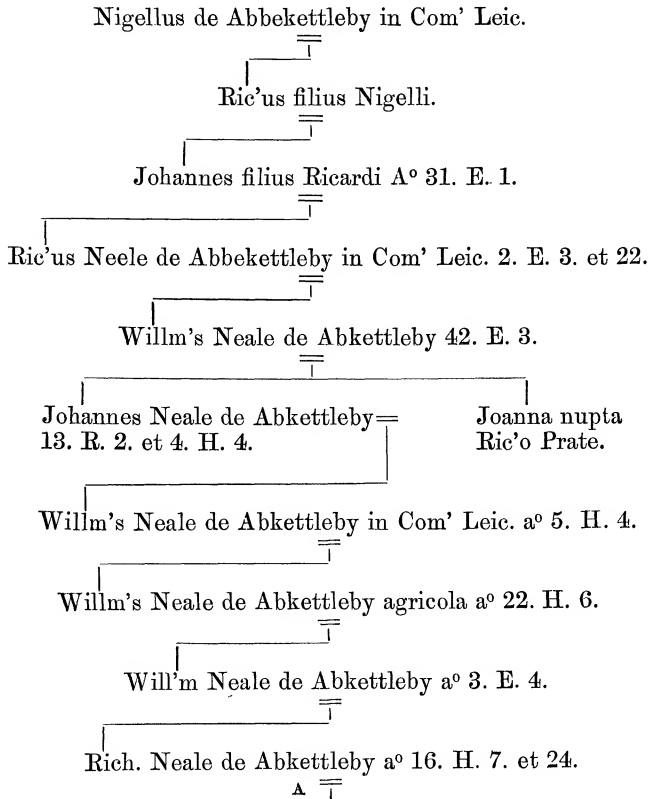

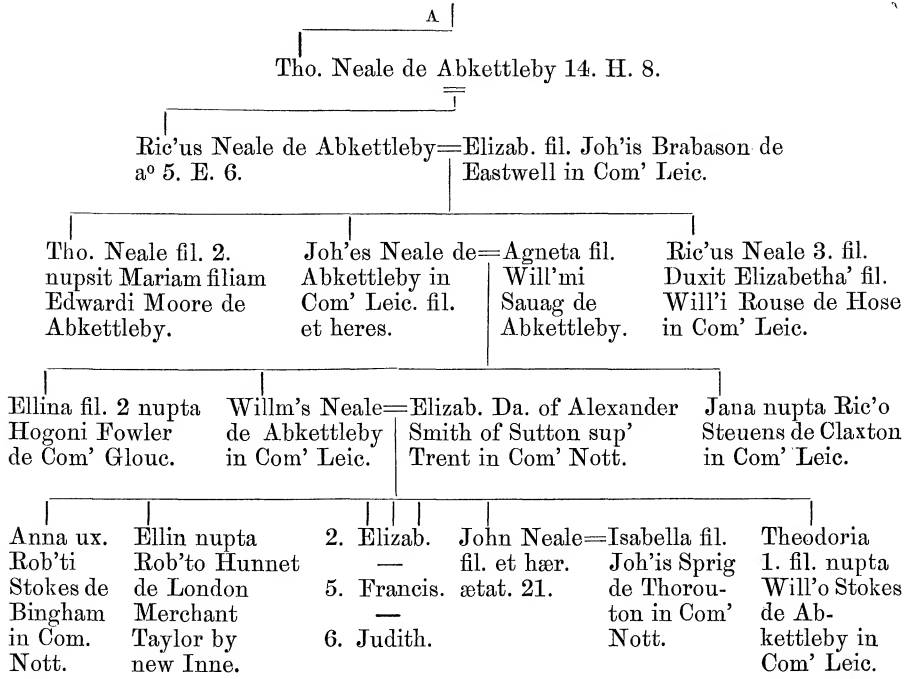

(Banister.)

ARMS. *Quarterly*:—1. *Argent, a cross flory sable within a bordure gules bezantée.* 2. *Argent, on a fess gules three escallops or.* 3. *Argent, a chief vair gules and or, over all a bend engrailed sable.* 4. *Argent, on a chief azure two mullets or, over them a label of three points ermine.* 5. *Paly of six or and gules, on a bend azure, three horseshoes of the first.* 6. *Argent, six lions rampant sable, three, two, and one.* 7. *Vair, argent and sable.* 8. *Sable, a lion rampant argent.*

CREST. *A peacock sitting (untinctured), gorged with a collar gules charged with three bezants.*

Phillippus Banister de Guonshall. 4 mille passus a Staffordia.

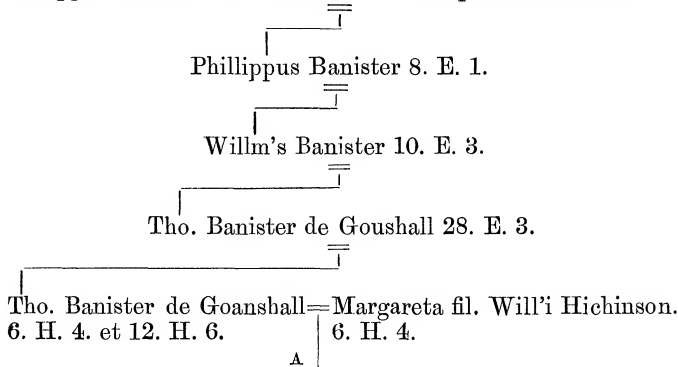

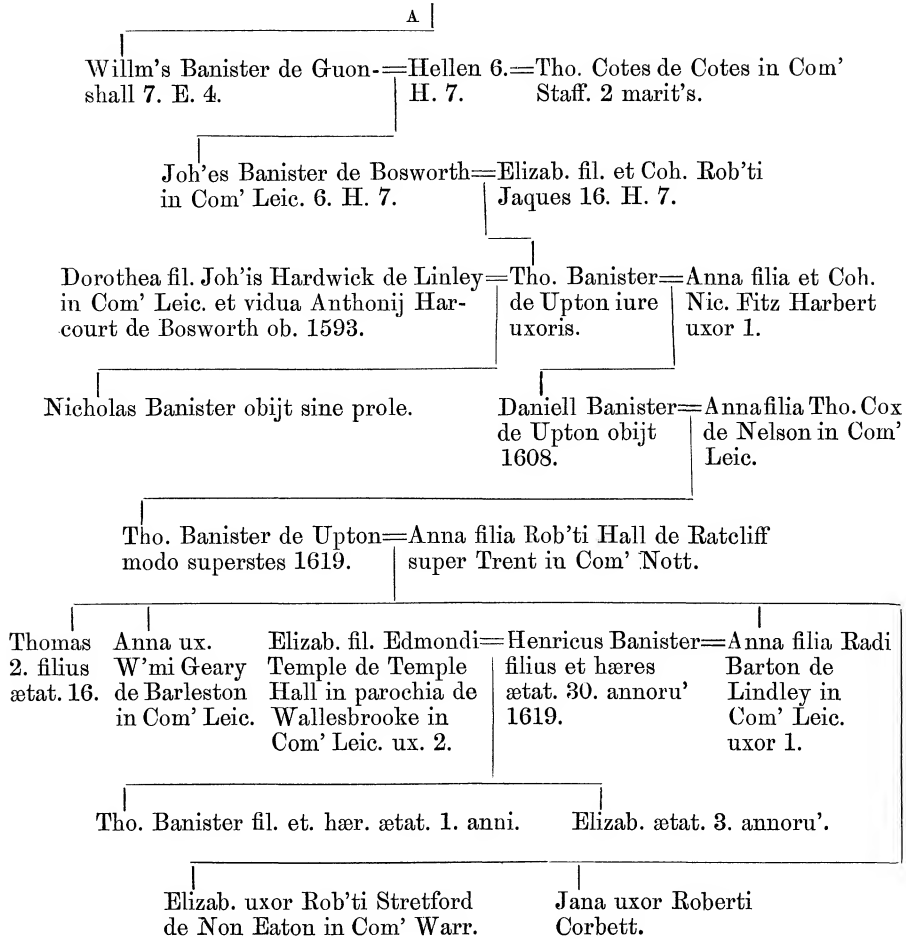

(Bothom.)

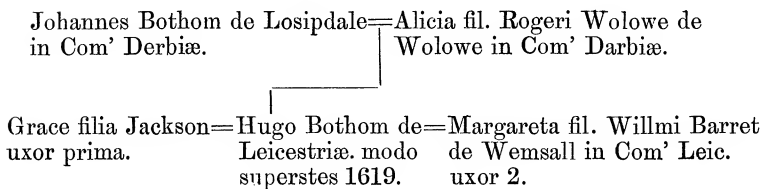

(Lacy.)

Hugh Lacye who cam out of Yorksh. & liued = Elizab. fil. . . . Noell de
at Melton Mowbray in Com' Leic. | Ilcott in Com' Staff.

Andrew Lacy de Melton Mowbray = Elizab. fil. Ric'i Wilcockes de
in Com' Leic. | Barswell in Com' Leic.

2. Jana.	3. Maria.	Willm's Lacy fil. et hæres ætat. 16. 1619.	Hen. Lacye fil. 2. ætat. 7.	Elizab. uxor Joh'is Stanbridg de Com' Mid.
3. Agnes.				

(Harcourt.)

ARMS. *Gules, two bars or, in chief a mullet for difference.*

CREST. *On a ducal coronet or, a peacock sitting proper.*

Willm's Harcourt de Cadby in Com' Leic. = Janna filia & heire Palmer.

Antonius Harcourt de Cadby = Dorothis fil. & Coh. Joh'is Hardwick
in Com' Leic. | de Linlick in Com' Leic.

Georgius Harecourt de Dadlington in Com' Leic.	= Elizab. fil. Henrici Leigh de Russel in Com' Staff.	Franciscus Harcourt occisus apud Hauer de grace.
--	---	--

Willm's Harecourt de Dad- lington in Com' Leic.	= Margareta filia Joh'is Shukbrough de Naseby in Com' Northamp.	Georgius Hare- court fil. 2.
--	--	---------------------------------

Jone nupta Joh'i Tew de Com' Warr.	Maria æt. 18. — Elizab. æt. 17.	Hanna æt. 14. — Margt æt. 8.	Edwardus Hare- court filius et hæres ætat. 22. annoru' 1619.	Georgius Harecourt filius 2. æt. 20.
--	---------------------------------------	------------------------------------	---	---

(Temple.)

ARMS. *Quarterly:—Sable, a chevron ermine between three martlets argent; and azure, a fess ermine between six sea news' heads erased argent.*

CREST. *A talbot séjant sable, collared and ringed or, charged on the shoulder with a mullet argent for difference.*

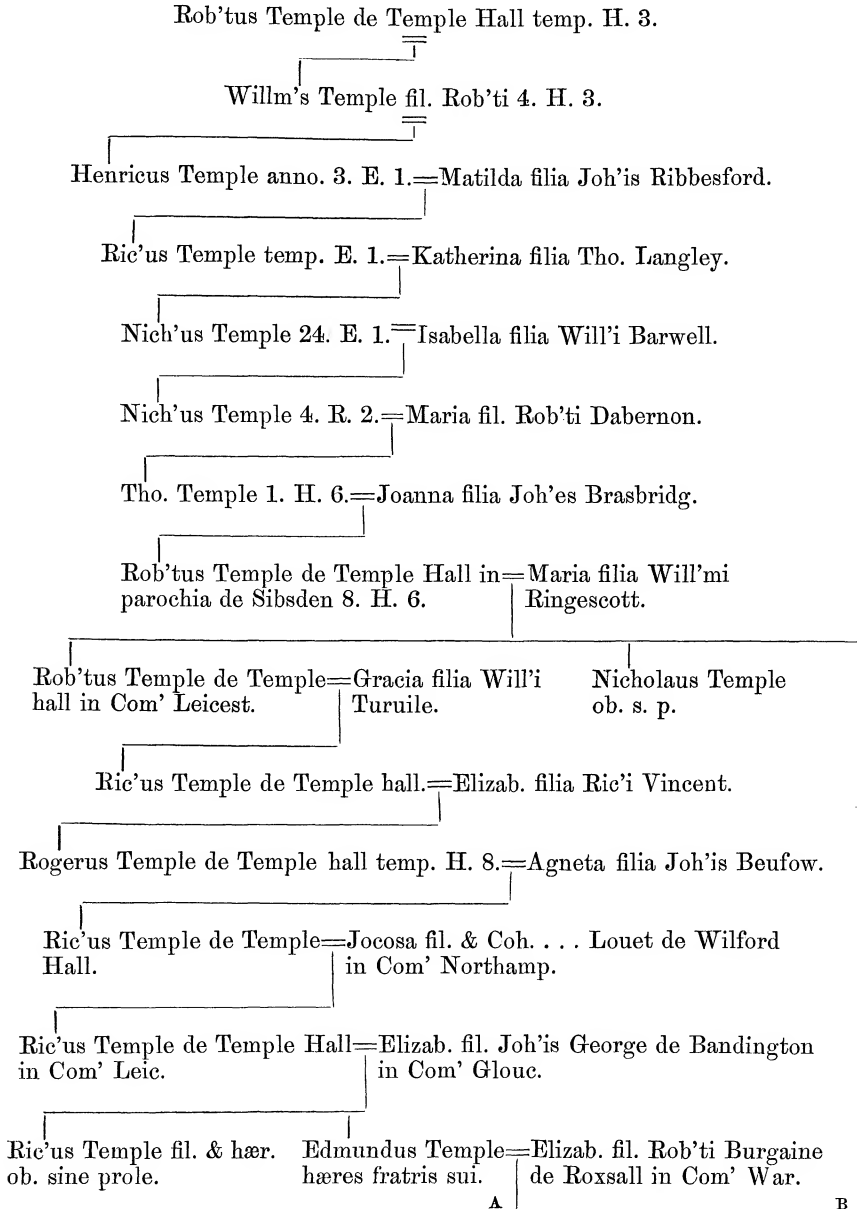

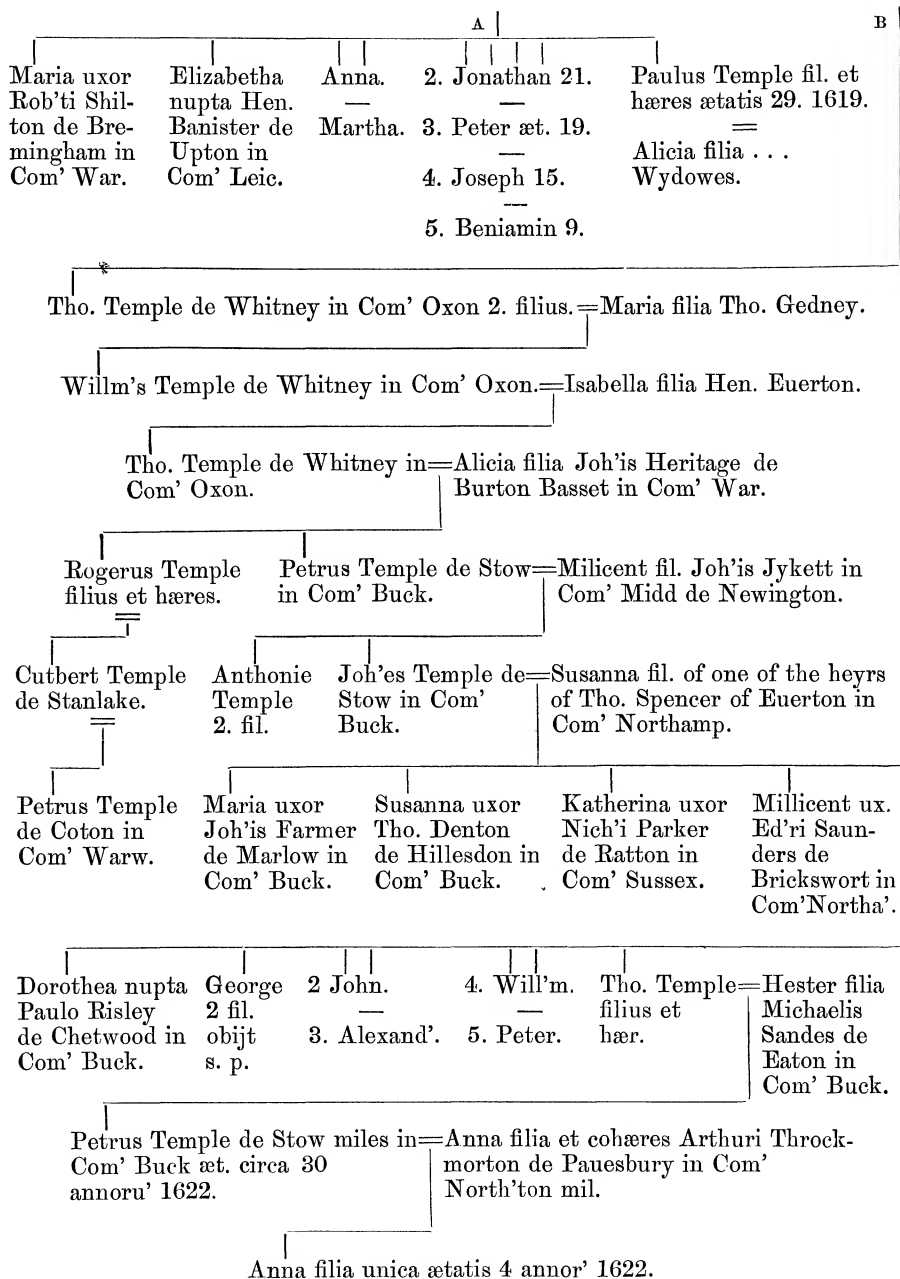

(Beaumont.)

ARMS. Quarterly :—1. Azure, semée of fleurs-de-lis, a lion rampant or. 2. Azure, three garbs or, banded gules. 3. Gules, seven mascles conjoined or, three, three, and one. 4. Gules, a cinquefoil ermine pierced. 5. Azure, a lion rampant argent, crowned or. 6. Argent, an inesccheon within a double tressure flory counterflory gules. 7. Azure, three garbs or. 8. Gules, a lion rampant vair. 9. Azure, a fess argent between three cinquefoils or. 10. Argent, a manuch sable, in chief a crescent of the last for difference. 11. Argent, a fess sable between three birds (vinctured). On an esccheon of pretence or, three vere-mice displayed gules.
 CREST. On a cap of maintenance azure, semée of fleurs-de-lis or, turned up ermine, a lion passant of the second.

Ludouic fil. Caroli R. Ceciliæ filij Ludouici 8. Regis=Alicia fil. et hæc Vice-Francoru' et frater Caroli Regis Ceciliæ.

Henricus de Bellomonte Baro vocatus Comes Boghan ob. 14. E. 3.

Ludouicus de Bellomonte Ep'us Dunelm'.

Johannes de Bellomonte=Aliamora filia Henrici Comitis=Ric'us Comes Arundell. Isabella nupta Henrico Duci Lancastriæ.
 obiit 16. E. 3. Lancast' ob. 47. E. 3. 2. maritus.

Henricus D'ns de Bellomonte.=Margareta filia Joh'is Vere Comitis Oxon'.

Joh'es de Beaumont ob. 20. R. 2. fuit miles Garterij.=Katherina fil. et her. Tho. Eueringham de Laxton militis ob. 5. H. 6.

Ricardus Ciceilia uxor Elimora monialis. Henricus de Beau.=Elizab. filia Willmi Tho. Beaumont miles=Phillippa fil. et her. Tho.
 s Beaumont D'ni Bo- apud Amsburie. mont miles ob. 1. D'ni Willoughby D'ns de Baqueville in Marward de Quarter-
 2 filius. treaux. H. 5. ob. 6. H. 6. franciã 5. H. 6. fl. 3. mersh in Com' Leic.
 A B

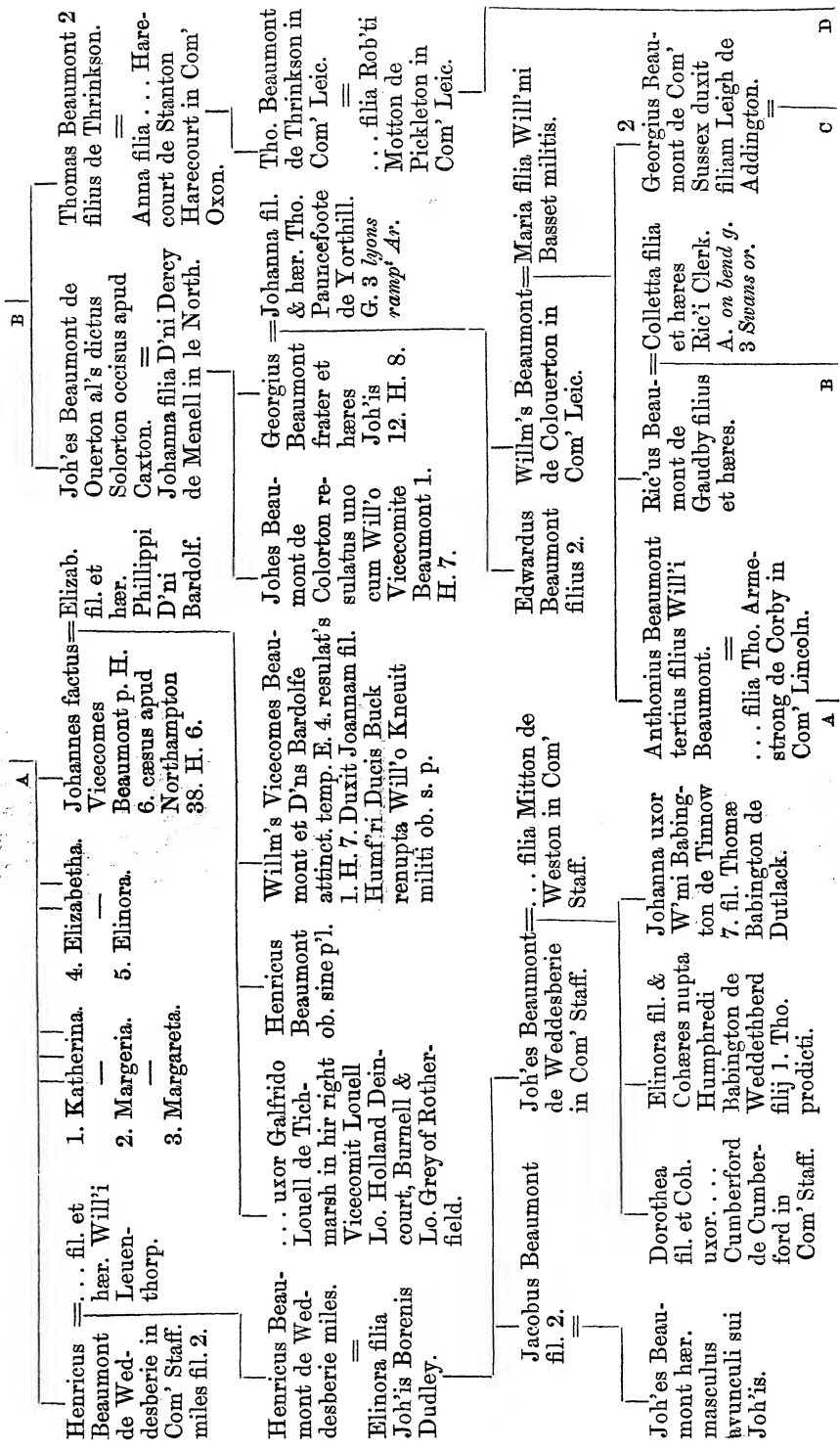

A		B		C		D
Franciscus Beaucus filius et hæres miles	Georgius = Maria nupta = Thos. Compton miles frater Will'i Reynier 2. maritus. illa fuit Creatura Comitissa Buck. p' Jacobu' Regem. 1618.	Anna ux. Will'i Brett de Rotherby in Com' Leic. . . . filia ux. Ashby — Dorothea ux. . . . Hill de Com' Warr.	Aueria uxor Tho. Findern de Finnerne s. p. — Henricus Beaumont Prebendarius de Winsor.	Nicholas Beaumont of Colouerton in Com' Leister. ob. 1585. = Anna filia Will' mi Saunders de Mel-ford in Com' North.	Tho. Beaumont de Sussex habuit uxores. — Hen. Prebendarius de Windsor.	
Filia ux. Comitiss et Baronis Maxwell.	Huntington Beaumont. 3. fl.	Sr. Henry Beaumont = Elizab. fl. & hæ. . . . Leois Ciuis London.	Sr. Tho. Beaumont = Katherina fl. et hæ. de Stoughton in Com' Leic.			
Tho. Beaumont de Colouerton in Com' Leic. = Elizab. fl. & hæ. Hen. Sapcott de Elton in Com' Hunt.						
2. Henricus æt. 4.	Sapcott Beaumont fl. et hæ. ætat. 6. 1619.	1. Elizab.	4. Maria.	Thomas.	Jana ob. s. p.	
3. Thomas æt. 2.		2. Katherin.	5. Elianor.	Anna.		
4. Rob' tus.		3. Francis.				
Jana uxor Will'i Temple de London Mercator.	Isabell uxor Hugonis Snousell de Belton in Com' Eboru'.	Anna uxor Joh's Dillon de Fordinghoe. — Elizab. ux. Joh's Ashbornham militis.	Francisca ux. Wolstani Dixi de Bosworth in Com' Leic. — Maria uxor Ric'i Paramour de Loseby in Com' Leic. — Elinor.	Henricus Beaumont fl. et hæ. Miles duxit Elizab. fl. Will'i Turpen de Knopoft in Com' Leic. militis.	Farnam Beaumont 2 fl. — Thomas Beaumont 3 fl.	

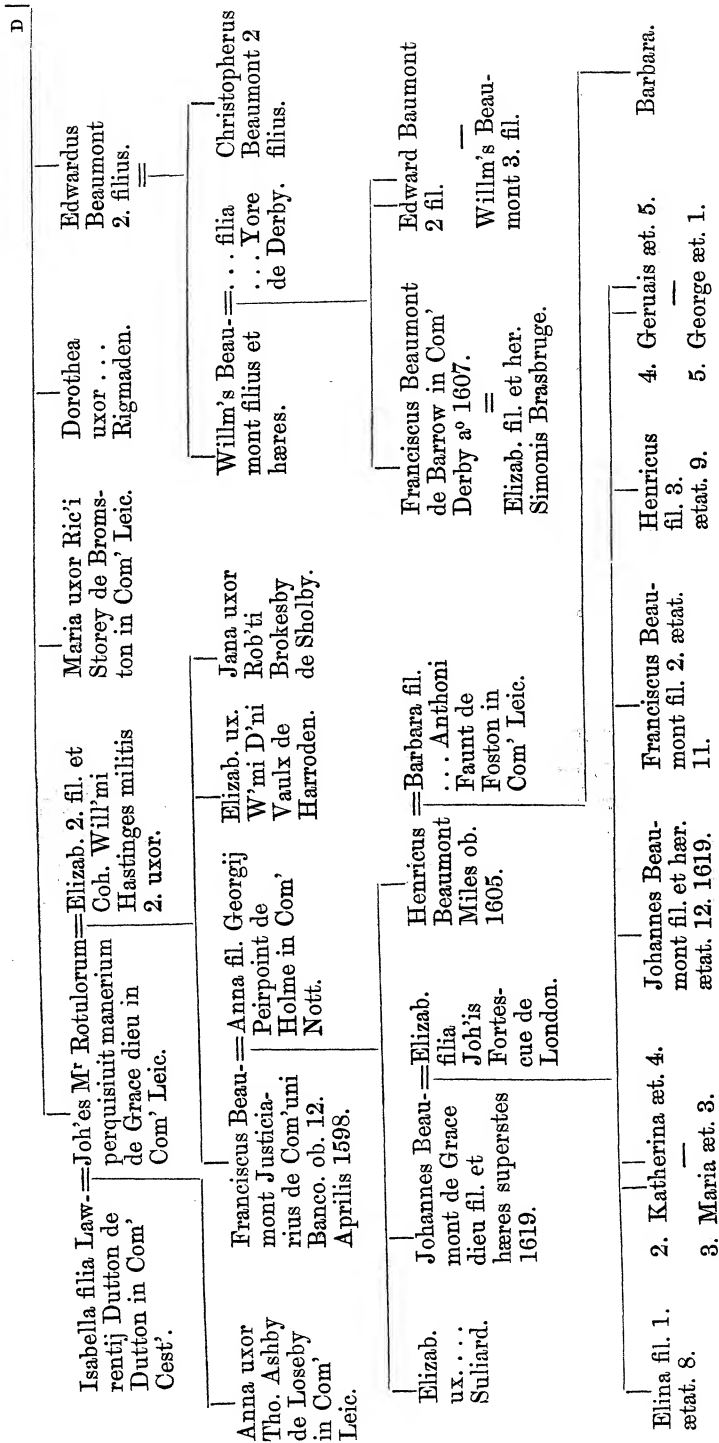

(Bickerton.)

ARMS. *Argent, on a chevron sable three pheons of the field.*

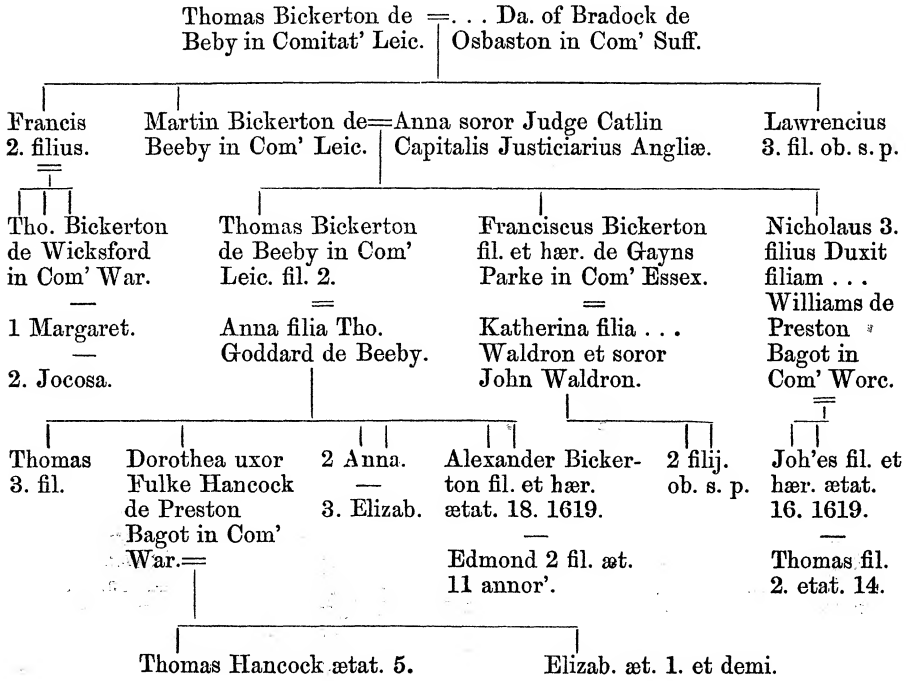

(Leigh.)

ARMS. *Quarterly:—1. Azure, two bars argent, over all on a bend gules in dexter chief a mullet or for difference. 2. Or, three lozenges azure. 3. Ermine, on a chief indented gules three ducal coronets or. 4. Argent, a fleur-de-lis sable. A mullet for difference.*

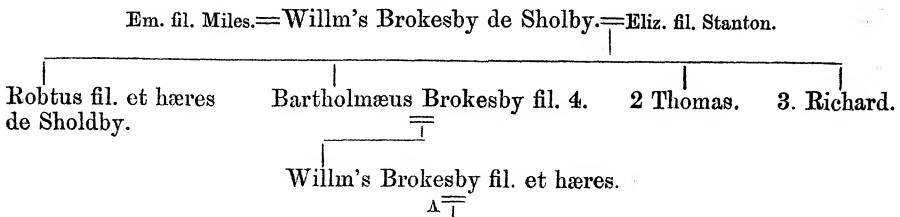

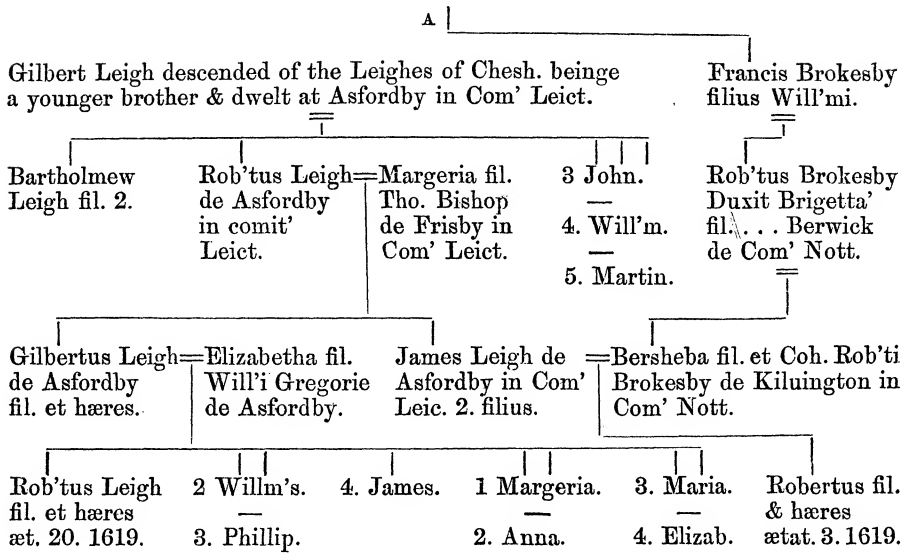

(Noone.)

ARMS. *Or, on a cross engrailed vert a crescent of the field for difference.*
CREST. *A double-headed eagle or, with wings displayed vert.*

This Coat & crest confirmed by W. Camden Clarenceux. 1611.

John Noone de Walton in Comitatu Lecestriae.

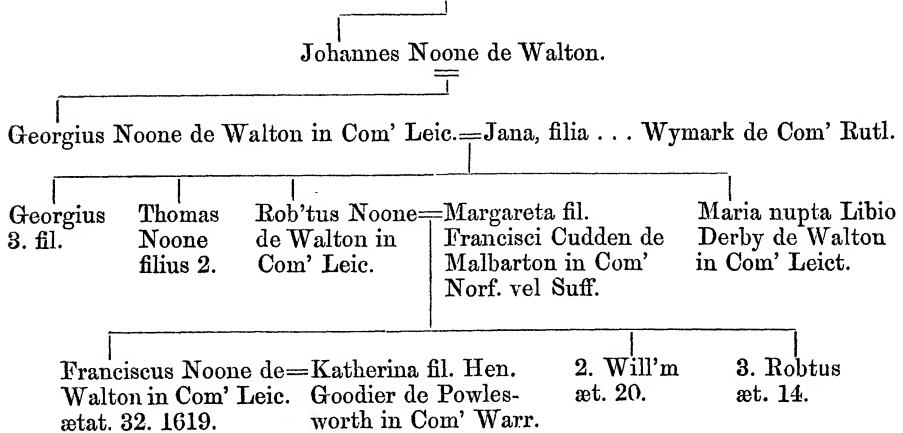

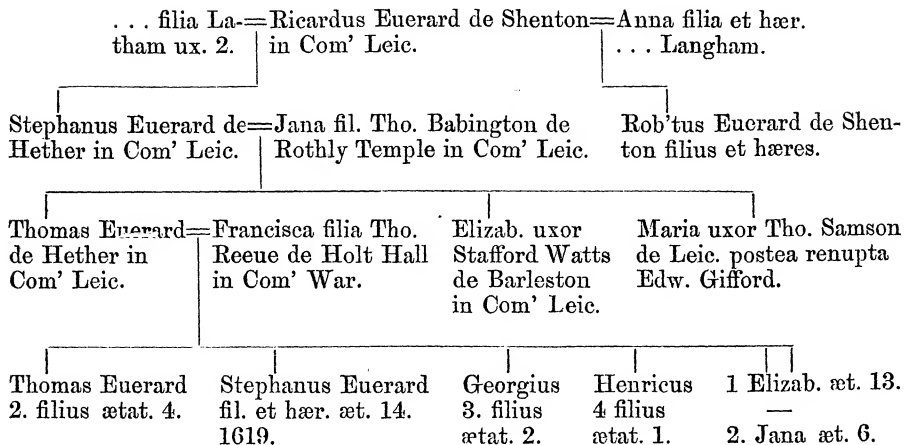
(Everard.)**(Starkie.)**

ARMS. (*Field untingured,*) a stork (*untingured*).

CREST. *A stork, holding in its beak a snake (untingured).*

Robertus Starkie de Stretton in Com' Cestriæ Ar.

Thomas Starkie de Tonge= Alicia filia Will'mi Dethick
 in Com' Leic. a^o 10. H. 7. | de Newhall in Com' Darb.

Rowland Starkie de = Cicilia fil. Thomæ Winter de
 Tonge in Comit' Leic. | Com' Leic. temp. 26. H. 8.

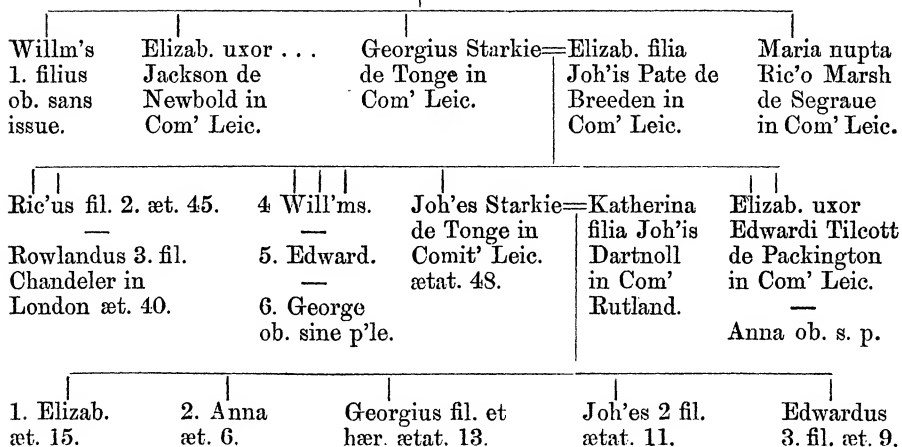

(Armeston.)

ARMS. *Sable, a chevron between three spear-heads argent, in chief a crescent for difference.*

CREST. *A dragon's head erased proper, charged with a crescent for difference.*

. . . Armeston who cam out of Lankesh.

Thomas Armeston de Thornteton in Com' Leic.

Tho. Armeston de Thornteton in Com' Leic. = Anna filia Petri Beck de Upton in Com' Leic.

Petrus Armston fil. et hæ. Tho. Armeston de = Anna filia Edw. Rep-
duxit Ellin fil. Thomæ Burbage in lingham in Com'
Alsop de Comit' Darbiæ. Com' Leic. Warr.

Willm's Armeston filius et hæres æt. 27. nunc Academicus in Oxonia. Thomas 2 filius ætat. 14. Jacobus 3 filius ætat. 13.

(Trimnell.)

ARMS. *Or, a cross engrailed gules, over all a bendlet azure.*

Rogerus Trimnell al's Trimnell de Com' Staff.

Tho. Trimnell 3. filius. Johannes Trimnell de Com' Staff. = Anna fil. . . . Fawknor. Rogerus Trimnell 2. filius.

Fardinando Trimnell 1. fil. ob. s. p. Basill Trimnell de Stoke Golding in Com' Leic. = Lucia filia Abelis Makepeace de Chipping Warden in Com' Northamp. Goditha nupta Waltero Britaine de Wincote in Com' Warr.

1 Dorothea æt. 16. Willm's Trimnell filius et hæres ætat. 14. Georgius 2 filius ætat. 10. 4. Lucia æt. 9. 2. Maria æt. 15. 5. Briget æt. 8. 3. Jana æt. 13.

(Corbet.)

ARMS. *Or, a raven sable, in chief a mullet gules for difference.*

CREST. *An elephant argent, trapped sable, surmounted with a tower, triple towered or (tinctured).*

Rob'tus Corbet de Morton in Com' Salopiæ. = Anna filia D'ni Windsor.

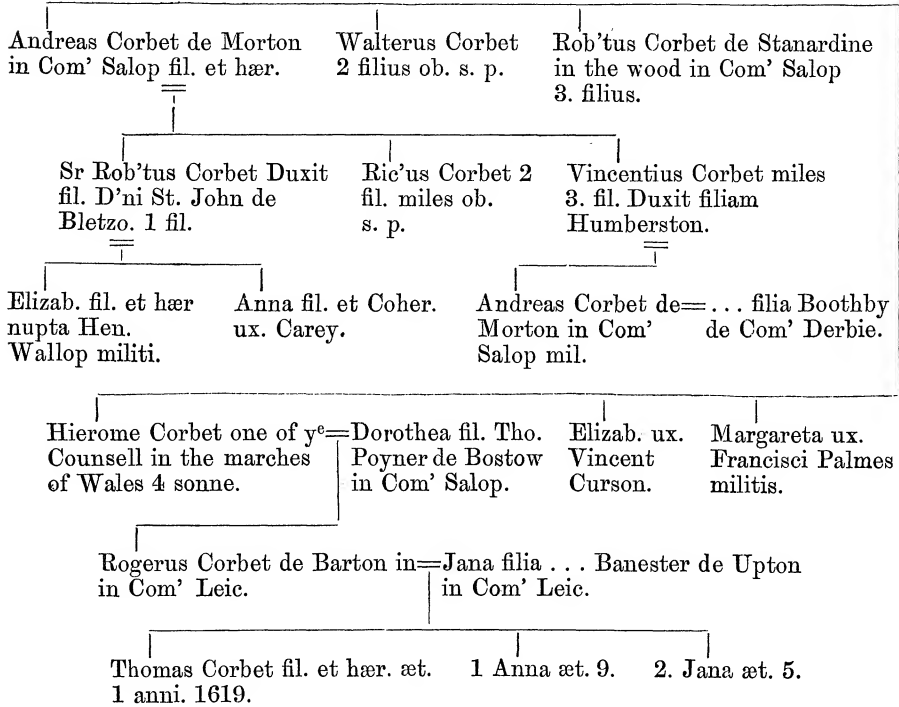

(Warde, alias Farmour.)

ARMS. *Vair, argent and sable.*

Thomas Warde who came out of Chesheire & had issue.

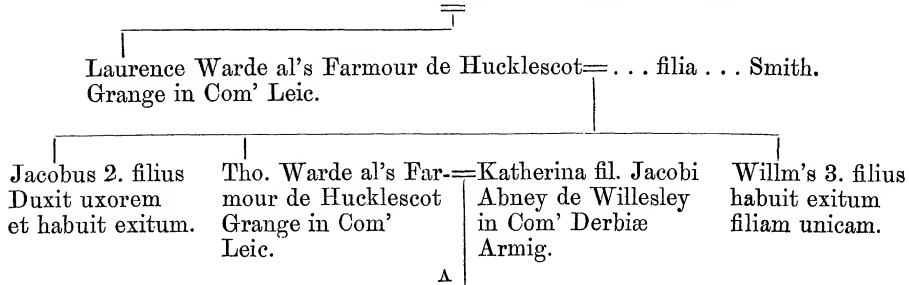

Δ

2 Δ

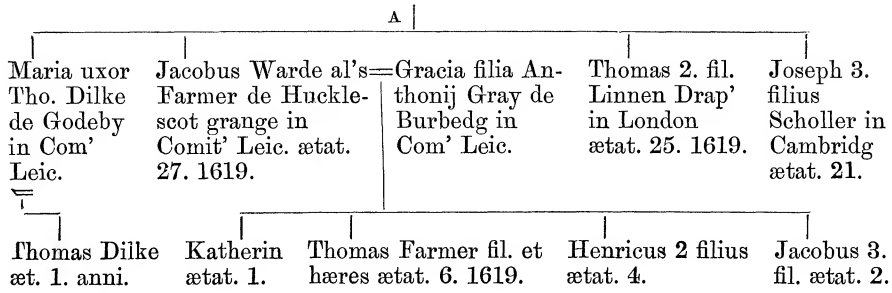

(Beresford.)

ARMS. *Quarterly*:—1. *Argent, three fleurs-de-lis between seven cross crosslets fitchée sable, three, two, and two.* 2. *Argent, three garbs azure, banded or.* 3. *Argent, three eagles displayed gules within a bordure engrailed sable.*

CRESTS. *First, A badger passant sable. Second, A dragon's head erased or, gorged with a collar gules, charged with a fess indented azure.*

Conventio matrimonij inter Joh'em Barford de Barkeby in Com' Leic. et Margeriam filiam Joh'is Fowler Junioris cum dotacio in terris in Barford, Thorpe Malford, Ardingworth et Sundelondes in Com' Northa' et Lubbenham in Com' Leic. Dat. 2^o Nouemb' a^o 21 E. 4.

John Beresford de Darby.

Joh'es Beresford de Barkeby in Com' Leic. 21. E. 4. = Margareta filia Joh'is Fowler nupta 21. E. 4.

Rob'tus Beresford filius Johannis. = . . . filia et hæ. Lole.

Willm's Beresford de Robottle et Shakerston.

Arthurus Berford de Shakerston in Com' Leic. = Dorothea fil. Joh'is Danuers de Swithland in Com' Leic.

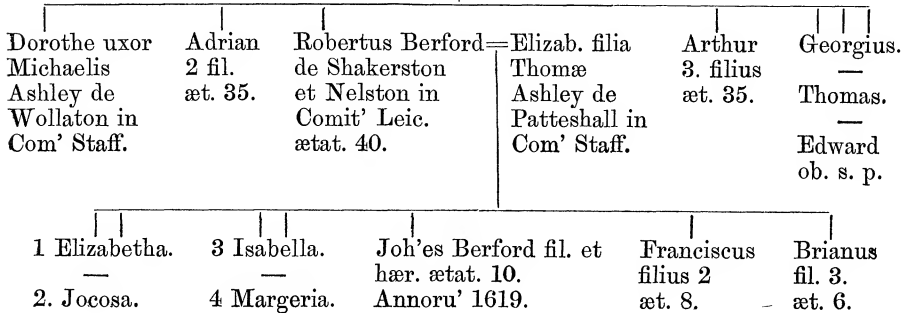

(**Farmer.**)

ARMS. *Sable, on a chevron between three lamps argent, flammant proper, a leopard's face between two mullets gules.*

CREST. *A dexter arm erect, couped at the elbow (untinctured), gauntleted, and holding a lamp argent, flammant proper.*

Barthomeus Farmer de Ratcliff in Com' Leic.=Margeria.

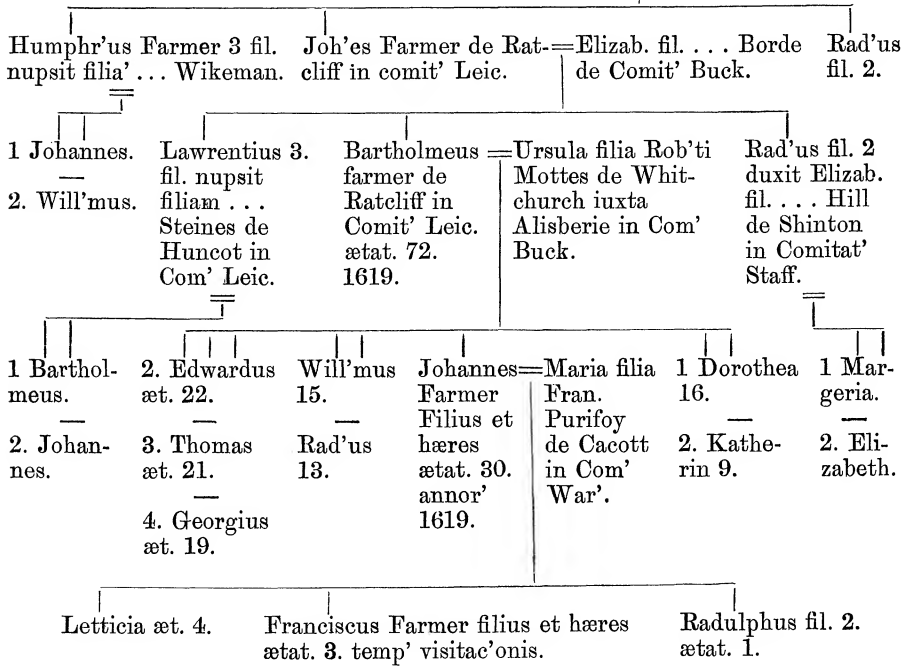

(**Mountney.**)

ARMS. *(Field untinctured.) A bend between six martlets (untinctured).*

CREST. *A wolf séjant, collared and lined (untinctured).*

Thomas Mountney de Mountneys Playne in Com' Norff.

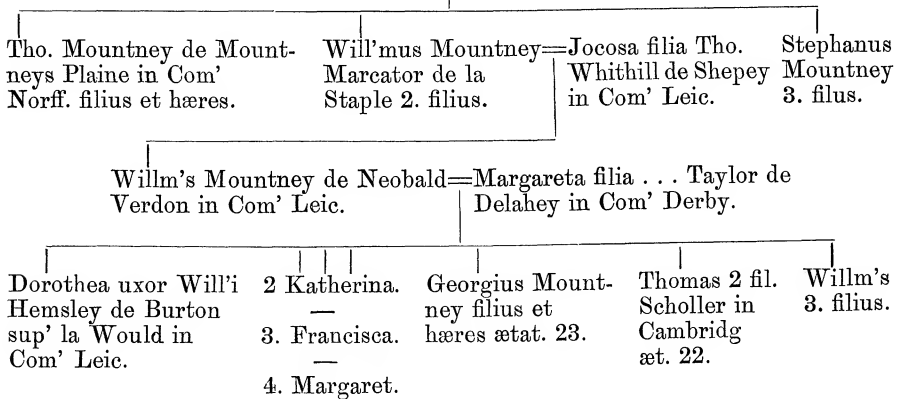

(May.)

ARMS. *Gules, on a fess between eight billets or, a crescent for difference.*

CREST. *Out of a coronet or, a leopard's head gules, charged on the neck with a crescent for difference.*

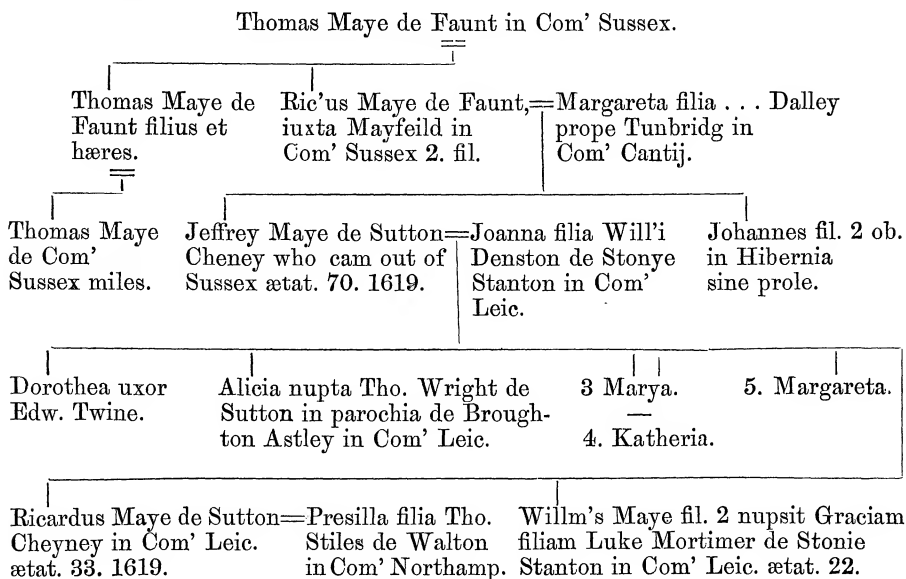

(Gee.)

ARMS. *Gules, a sword in bend argent, hilted and pomelled or, in chief a crescent for difference.*

CREST. *A dexter gauntlet erect proper, grasping a sword argent.*

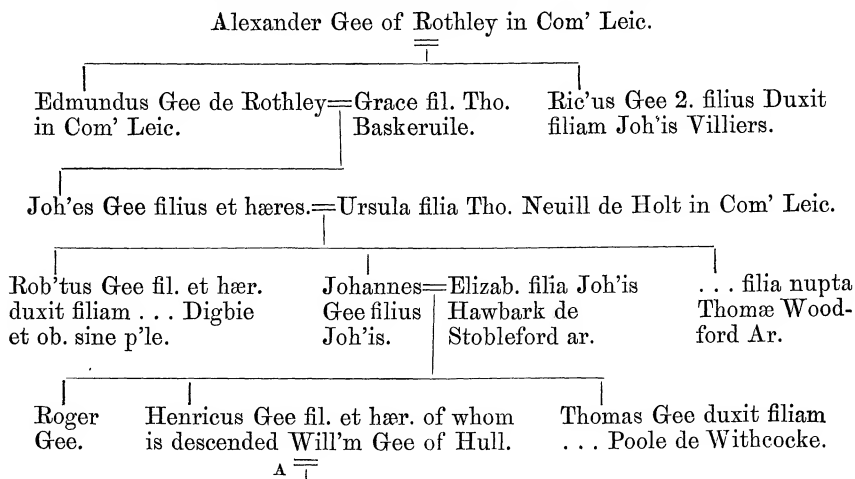

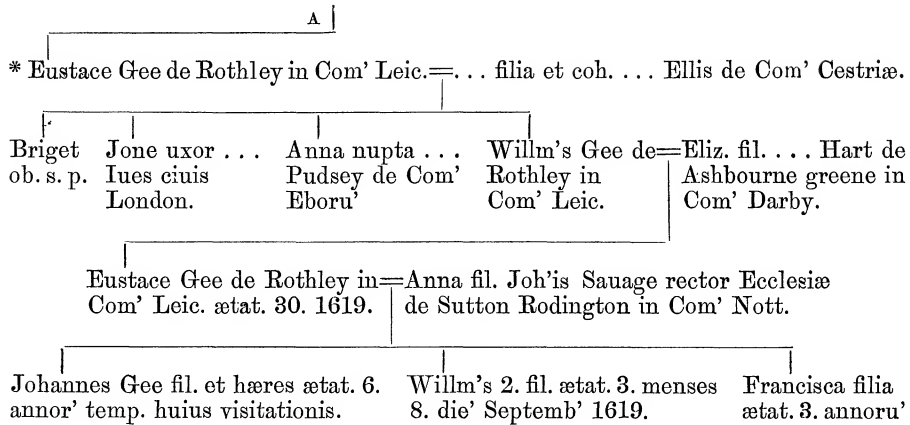

* *This descent in the original is on the side, opposite to Eustace Gee of Rothley and fil. et coh. Ellis de com. Cestriæ.*

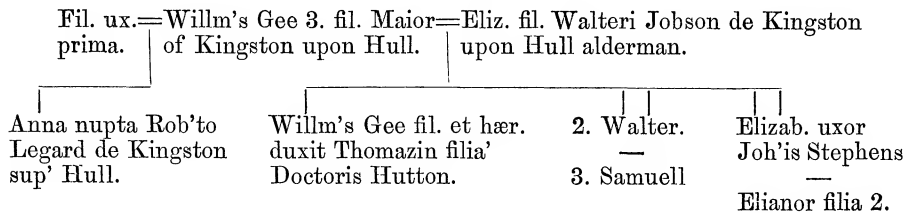

(Baynbrige.)

ARMS. *Argent, a chevron embattled between three battle-axes sable.*

CREST. *On a mount vert a goat statant (untinctured), attired and collared argent.*

To Will'm Bainbriges of Lockington in Com' Leic. by Will'm Flowre Norrey
14. feb. 1585. a^o 26. Elizab.

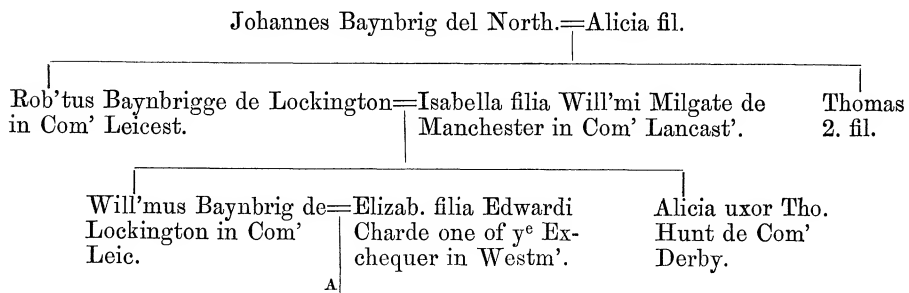

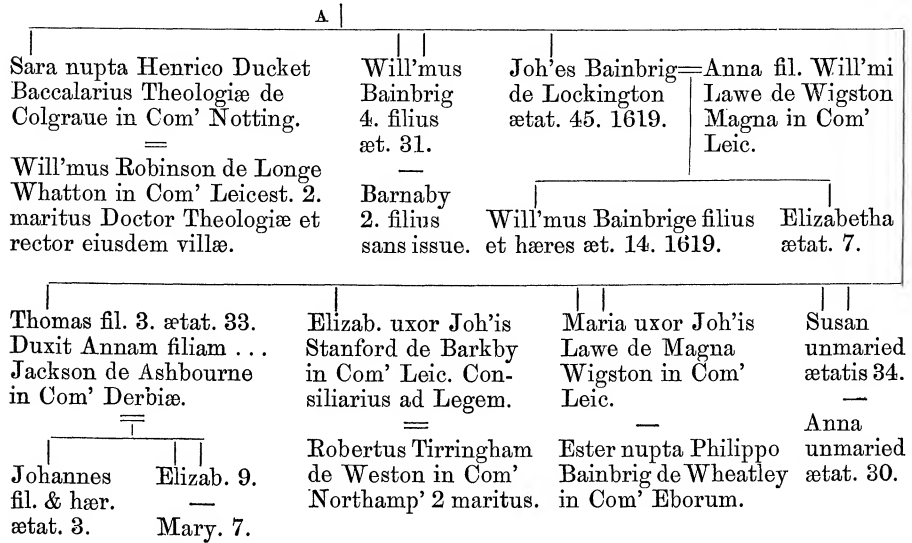

(Robinson.)

ARMS. *Vert, on a chevron between three stags statant or as many trefoils slipped gules, in chief a crescent for difference.*

Willmus Robinson descended out of y^e North.

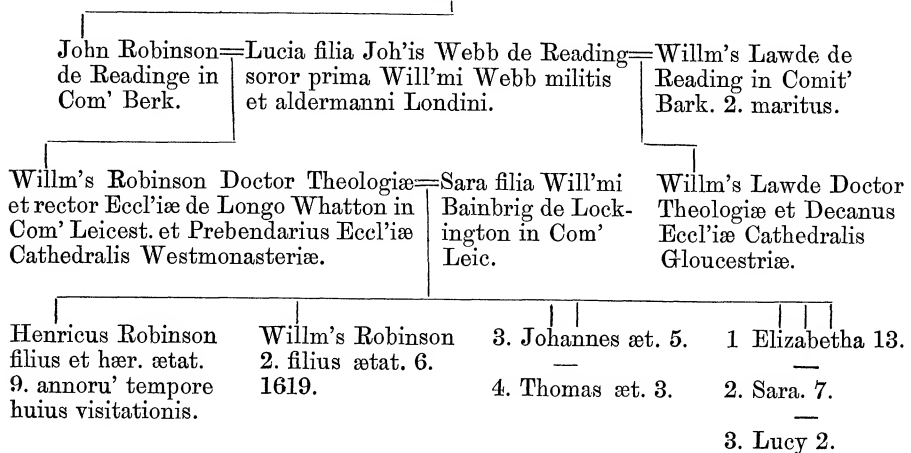

(Eyton.)

ARMS. *Quarterly*:—1. *Or, a fret azure.* (EYTON.) 2. *Barry of six ermine and gules.* (HUSSEY.) 3. *Argent, a fess between three sinister wings sable.* (DERBY.)
 CREST. *A lion's head argent, holding in his mouth a tun or.*

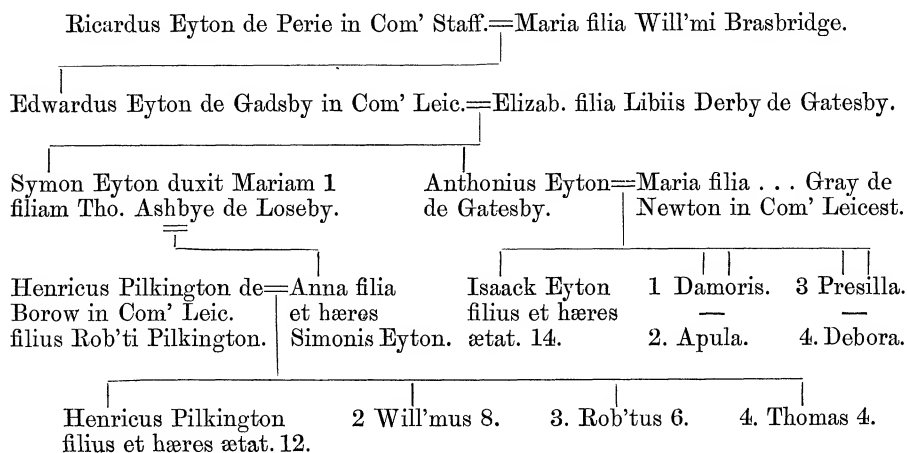
**(Morton.)**

ARMS. *Argent, on a chevron gules between three demi-buckles, tongues pendant, sable, a mullet or for difference.*

Willm's Morton de Bosworth in Com' Leic.
descended of Morton of Morton in Com' Staff.

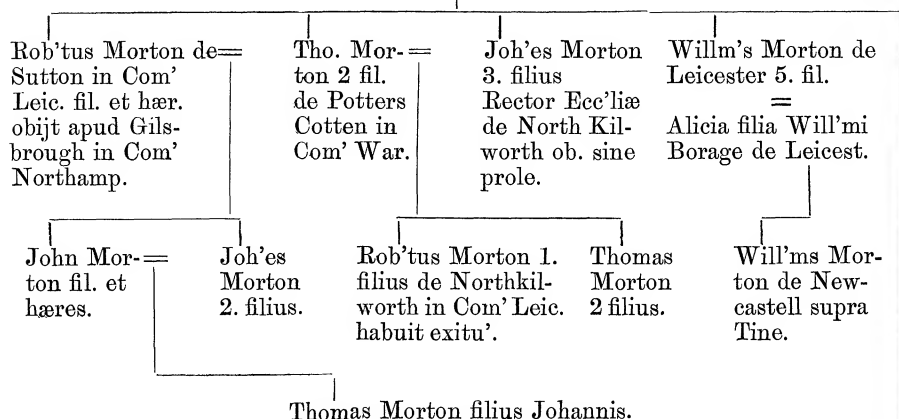

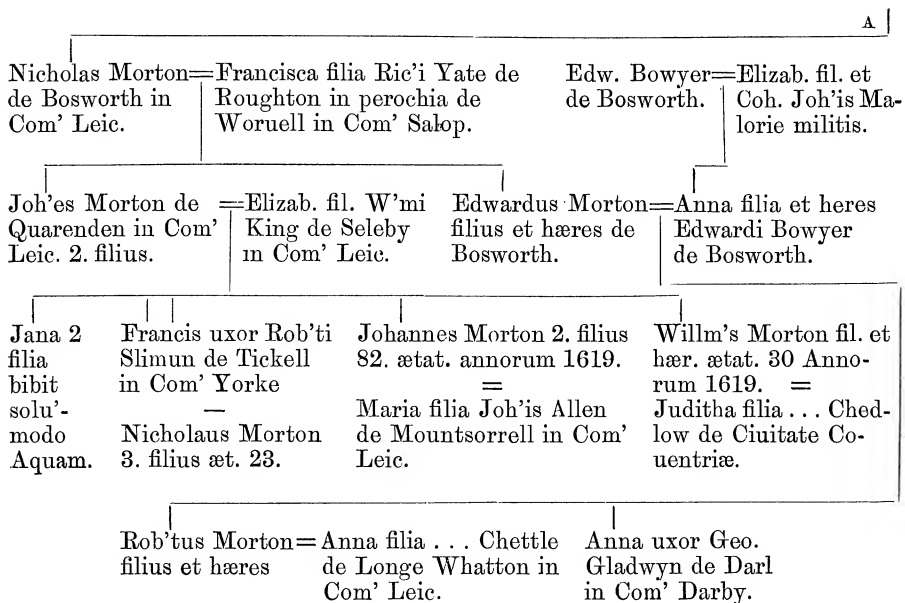

(Hollingworth.)

ARMS. *Azure, on a bend argent three holly leaves slipped vert.*

Hollingworth = filia Duncalf.

Hollingworth = filia Leuerseege.

Radulphus Hollinworth de Bushingthorp in Com' L'ncolne whose father came fro' Mottra' in Chesheire.

= Isabella filia . . . Shaw de Com' Lincoln.

Francisca filia Tho. Saunder son de Weston in Com' Leic. relicta Will'mi Ashby 3. uxor.

= Radulphus Hollingworth de Wheston in Com' Leic. duxit Emmot filia Will'mi Carre de Com' Lincolne 2. uxor.

= Susanna filia Joh'is Whitby de Comitatu Ebor' uxor prima.

Radulphus Hollingworth filius et hæres ætat. 24. modo Academicus Oxoniæ.

Patience uxor Tristam Holland Ciuis Londini.

2. Ellina 20.
—
3. Susan 18.

4. Elizab. 17.

George Holland filius et hæres ætat unius anni 1620.

(Salisbury.)

ARMS. *Gules, a lion rampant argent, charged on the shoulder with a crescent for difference, between three crescents or.*

CREST. *On a mount (uninctured) a lion rampant argent, and charged on the shoulder with a crescent for difference, in dexter paw a crescent or.*

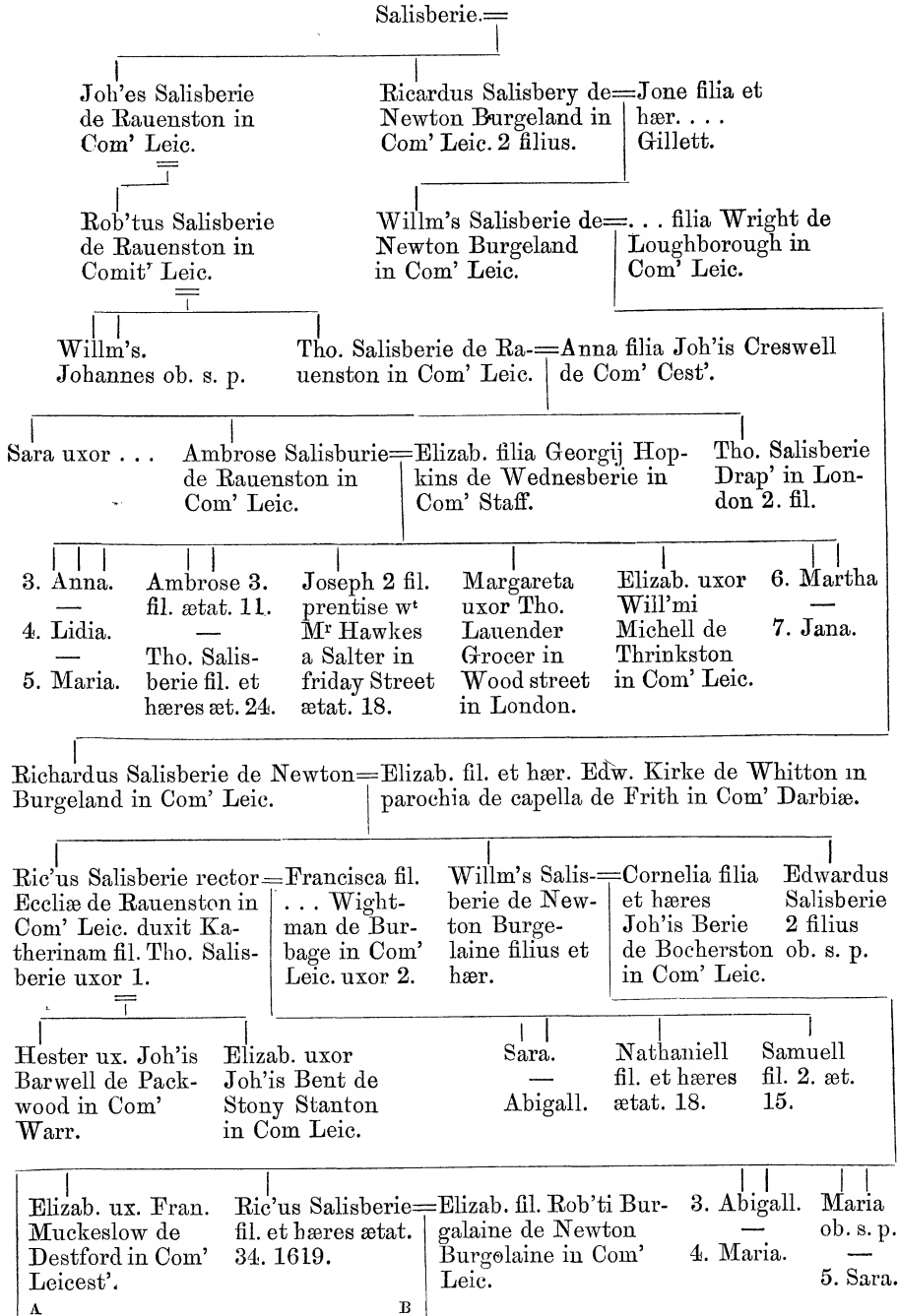

A

B

2 B

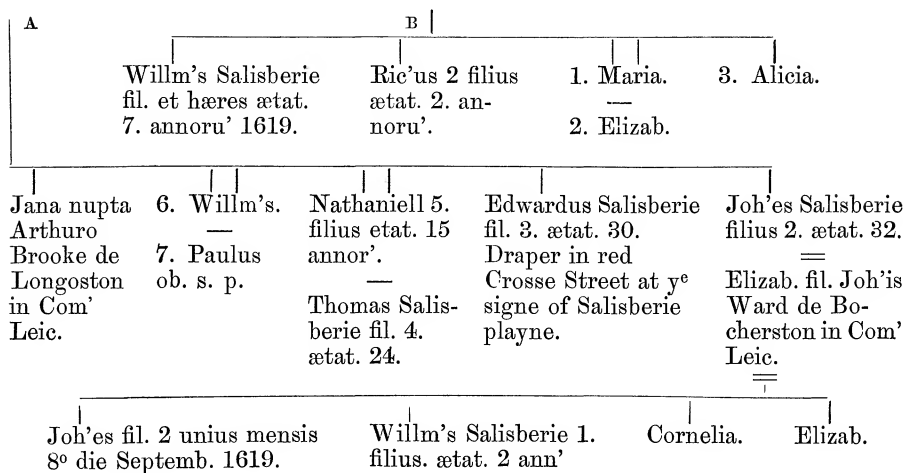

(Lacy.)

ARMS. *Quarterly*:—1. *Argent, six pellets, three, two, and one, a crescent surmounted by a mullet gules for difference.* 2. *Gules, six billets or, three, two, and one, on a chief indented three roundles (uninctured).* 3. *Per pale gules and sable, a lion rampant argent, crowned or.*

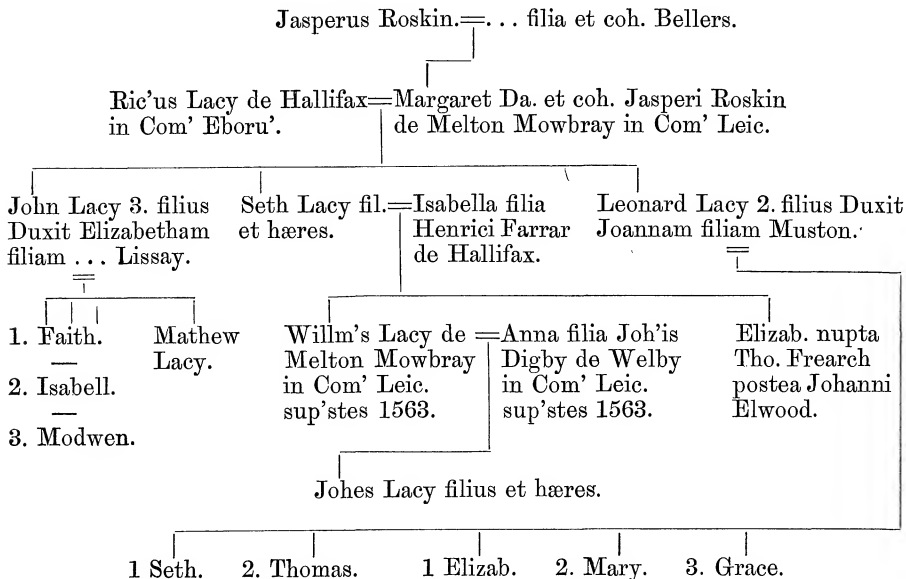

(Nicolls.)

ARMS. *Sable, three pheons argent.*

Nicolls del North tempore E. 4. et de Ecton in Comit' Northamp.

Thomas Nicolls de Picbley in Com' Northamp. et Anna filia Joh'is Pell de Eltington in Com' Northamp.
 ib'm sepultus. ob. 29. Junij 1563 ætatis. 38.

Franciscus Nicolls de Hardwick in Com' Northamp. fil. et hæres.	= Anna filia Daudidis Seamour.	Edwardus Bagshaw de London 1. maritus.	= Maria filia Heminges de London.	= Augustinus Nicolls de Faxston miles unus Justiciarius de Comuni Banco obijt 1617. sine prole.
---	--------------------------------	--	-----------------------------------	---

Maria ob. virginem.	Franciscus Nicolls de Hardwick et Faxston Ar. fil. et hæres consanguinius et hæres Augustini superstes a ^o 1619.	= Maria filia Edw. Bagshaw de London.	Johannes Bagshaw filius et hæres.
---------------------	---	---------------------------------------	-----------------------------------

Maria ætatis 2. annorum.

Willm's Nicolls de Tilton in Com' Leic. superstes 1619.	Susanna uxor Rob'ti Manley de Com' Warr.	Margeria ux. Michaelis Purifoy de Mussin in Com' Leic.
---	--	--

Jocosa filia Geo. Gifford de Botlebridg in Com' Hunt.	= Anna uxor Ed'ri Hasilrig de Thedingworth in Com' Leic.	Lodouicus Nicolls mercator London 3. fil. ob. s. p.
---	--	---

Augustinus Nicolls filius et hæres ætat. 11. 1619.	2 Will'mus æt. 2.	1 Maria 12.	3. Elizab. 6.
	3. Francis æt. 1.	2 Anna 11.	4. Jane. 3.

(Gregory.)

ARMS. *Quarterly*:—1. *Or, two bars and in chief a lion passant azure.* 2. *Argent, a saltire engrailed sable.* 3. *Azure, a lion rampant argent, crowned or, debruised by a bend gules.* 4. *Ermine, a fess paly of six or and gules.* 5. *Sable, two lions passant in pale argent, crowned or.* 6. *Vair, a fess gules, fretty or.*

CREST. *A demi-boar couped rampant sable, gorged with a collar or.*

Johannes D'ns de Grigorie = Matilda de Pekulton filia de Freseley et de Asforby. D'ni de Pekulton.

Ric'us iste dedit partem terrarum de Fresley Abbatia de Lilleshull in perpetuam Elimozinam.	Ric'us Gregorie Dn's de Freseley et Asfordby ob. 20. E. 1.	Nicholas 2 filius pater Adæ Gregory.	Walterus Gregorie 3 fil. pater Ric'i Gregorie.	Alicia nupta Hugoni, filio Stephani de Erdwick.
---	--	--------------------------------------	--	---

A

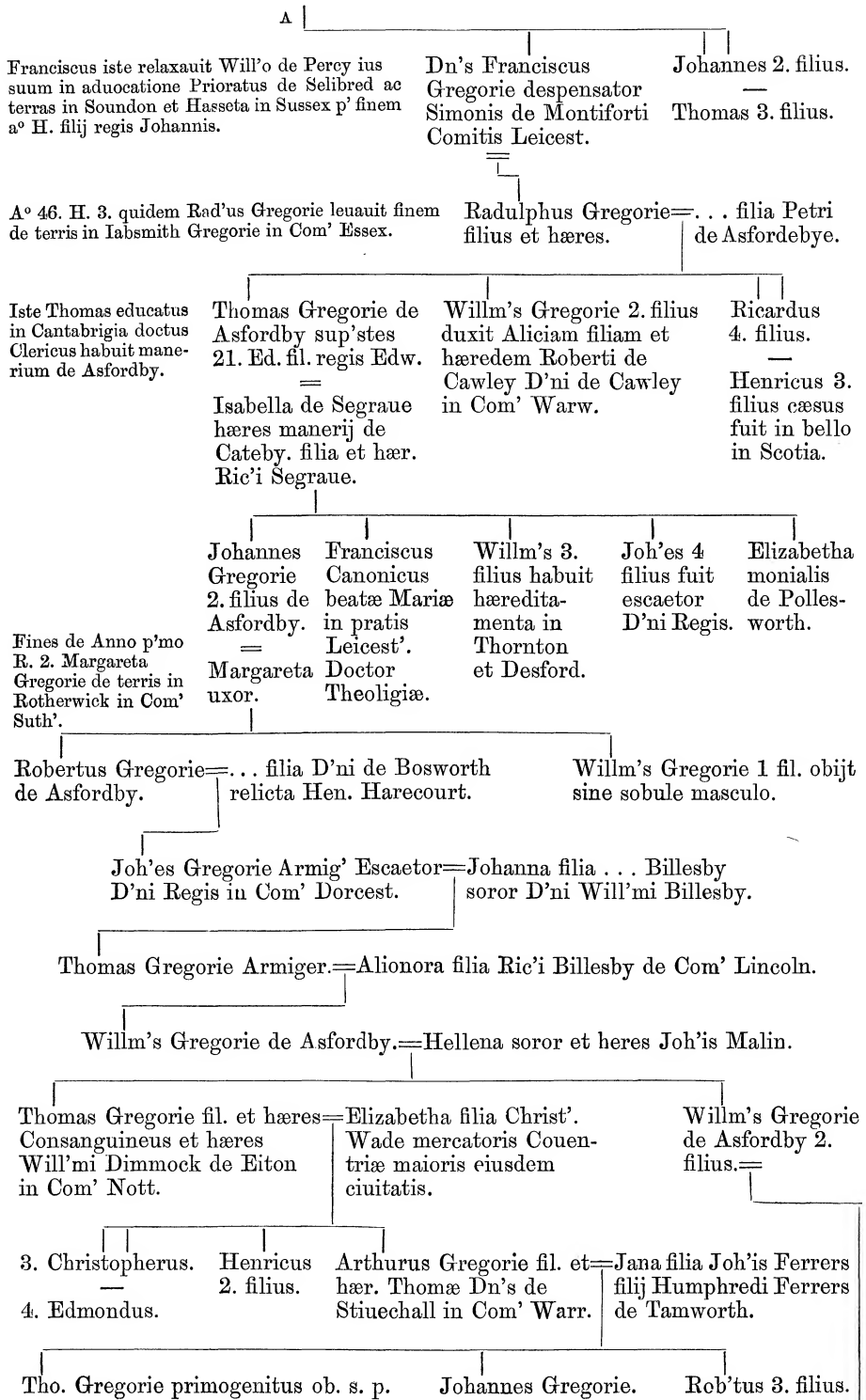

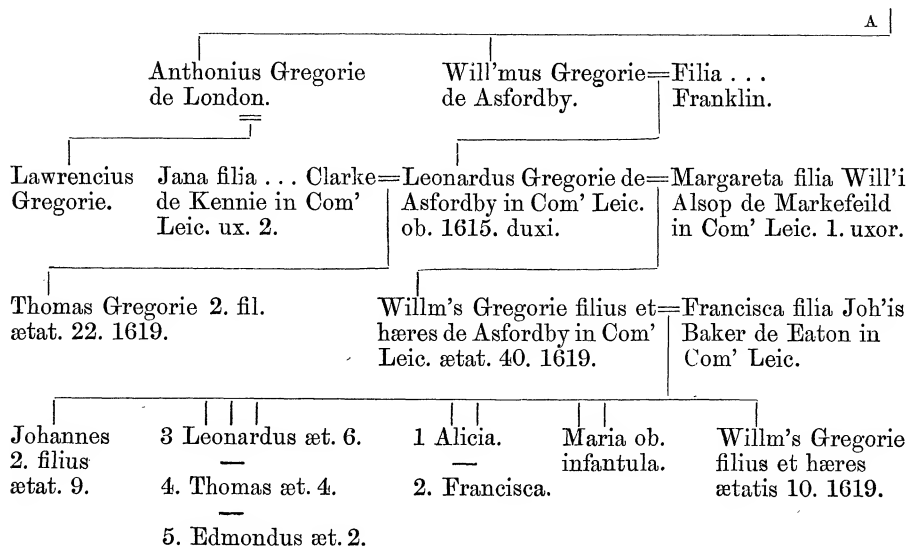

(Gilbert.)

ARMS. *Field (untinctured) a leg couped at the thigh in armour proper, spur or, between two broken spears in fess argent, in chief a mullet for difference.*

CREST. *An arm couped at the shoulder, embowed in armour proper, grasping a broken spear argent, the point downwards, staff or.*

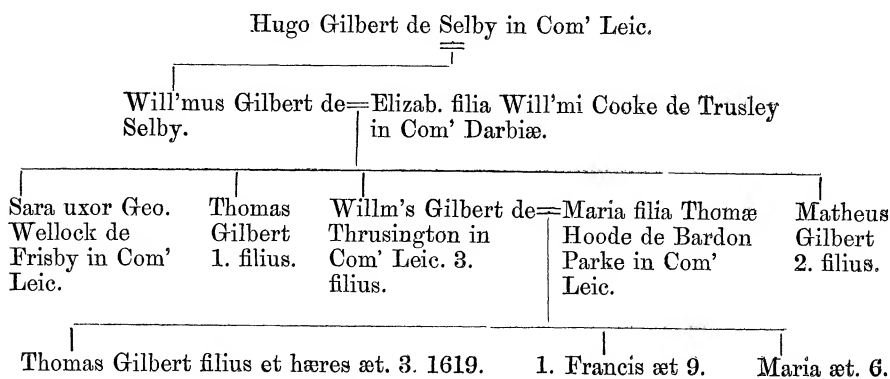

(Goddard.)

ARMS. *Azure, on a fess between three hawks' heads erased or, five lozenges conjoined in fess vert.*

Willm's Goddard de Beeby in Com' Leic. descended out of Barksheir.

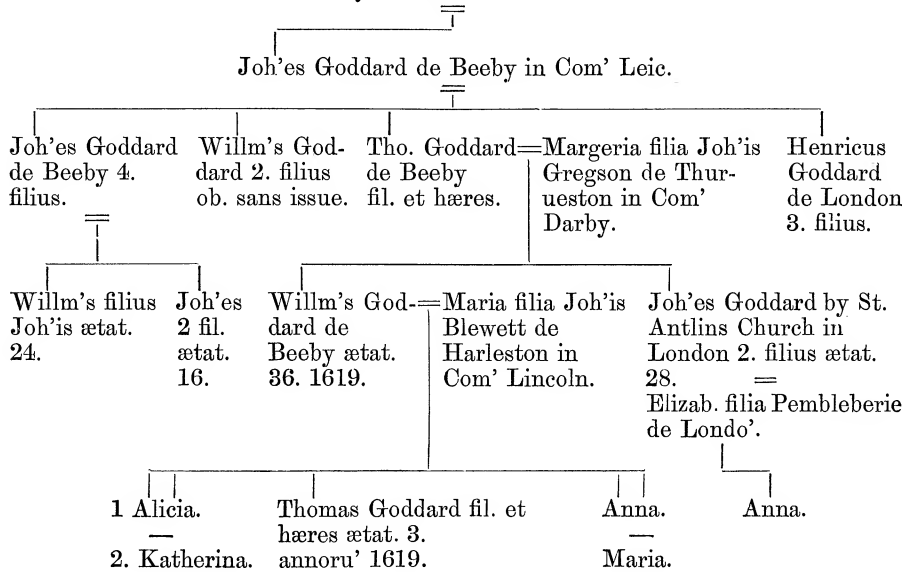
**(Bainbrig.)**

ARMS. *Argent, a chevron embattled between three battle-axes sable, in chief a crescent gules for difference.*

Joh'es Bainbrig de Wheatley in Com' Leic. = Alicia filia.

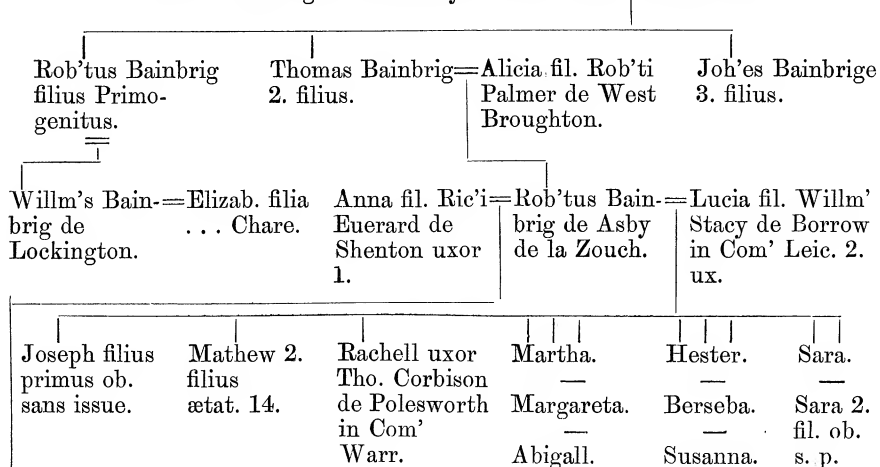

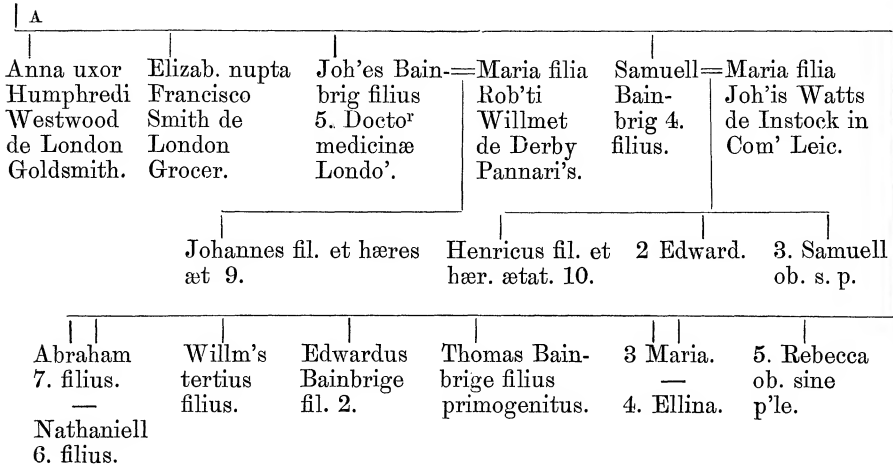

(Cotton.)

ARMS. *Quarterly*.—1. *Argent, a bend sable between three pellets.* 2. *Azure, an eagle displayed argent.* 3. *Gules, three birds or.* 4. *Barry nebulée of six argent and gules, a canton of the last.*
 CREST. *An eagle displayed argent.*

Thomas Cotton who came out of Staffordsh. & lyued in Chesh. temp. H. 7.

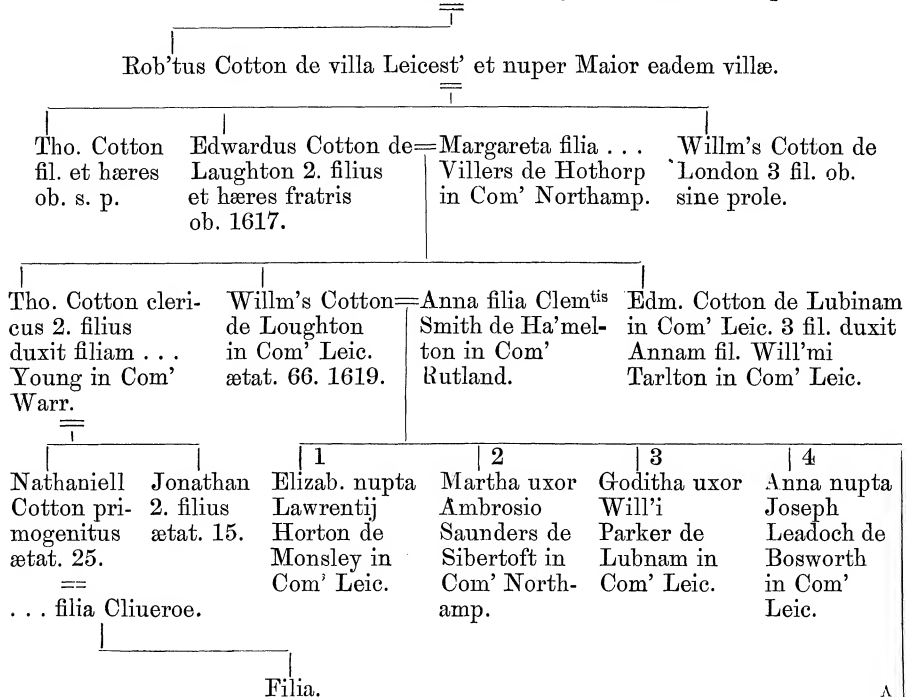

						A	
5. Ruth.	Jana uxor Hen. Sutton de	Samuell 3. fil.	Tho. Cotton de Loughton in Com' Leic' fil. et hæres.	=	Elizab. fil. Edw. Shukebrough de Naseby in Com' Northamp.	Joh'es Cotton 2. filius ætatis 21.	
6. Sara.	Galway in Conaugh in Ire-	land Clericus.					
7. Dorothis.							
Ann 1. Elizabeth 2.	Mary 3.	Thomas Cotton son & hr liuing 1649.	Edwardus Cotton filius et hæres ætat. 2. annoru' 1619. ob. s. p.	William Cotton 2.	Samuell Cotton 3. sonn.	Robert 4. Eusiby 5.	Henry 6. John 7.

(Caldwall.)

ARMS. *Quarterly:—Azure, a cross patée fitchée within an orle of étoiles or; and argent, on a fess indented sable three fishes' heads erased and erected or.*

CREST. *A cock's head or, beaked and combed gules, between two wings displayed sable, holding in his mouth a cross patée fitchée of the first.*

Thomas Caldwall.=Alicia filia . . . More de Douebridg in Com' Darbiæ.

Willm's Caldwall de Burton super Trent. 2. filius.	=	Johanna filia Will'mi Fishwick.	Rob'tus Caldwall 4. filius.	Ricardus Caldwall 3. filius.	Thomas Caldwall 1. filius.	
Rob'tus Caldwall de Whitford in Com' Wigorne.	=	Anna filia . . . Helmsted de Ingerston in Com' Essex.	Edwardus Caldwall de Upton Warren in Com' Wigorne 3. filius.	=	Maria filia . . . Skinner de Com' Kent.	Johanne 4. filius. — Joseph 5. filius. — Willm's Caldwall 2. filius.
Talbott Caldwall filius et hæres.	Rob'tus Caldwall fil. et hæres.	=	. . . filia Smith de Stoke in Com' Worc.	Samuell Caldwall 2. filius de Com' Leic.	=	Dorothy filia W'mi Morton Aldermanni Leicestriæ relicta Baker.
Edwardus Caldwall filius et hæres ætat. 6.	Georgius Caldwall filius et hæres ætat. 5. 1619.	Johannes 2 filius ætat. 2.	Anna æt. 1.			
1 Maria uxor Joh'is Weston de Com' Cantij.	2 Anna nupta Edwardi Purshull de Purshull hall in Com' Wigorn.	Sara ux. Gerrard Dannet fil. et hæres. Joh'is Dannet de Com' Worc. militis.	Jane uxor Joh'is Acton de Com' Hereff.	Presilla uxor . . . Nicolls de Com' Heref.	Rebecca ob. sans issue.	

(Eyre.)

ARMS. *Argent, on a bend sable three quatrefoils of the field.*

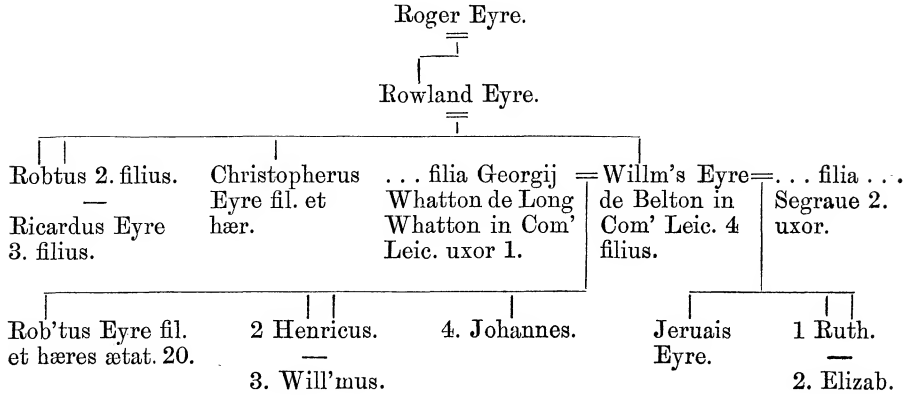

(Overton.)

Ricardus Orton al's Ouerton de Lea in Com' Leicest.

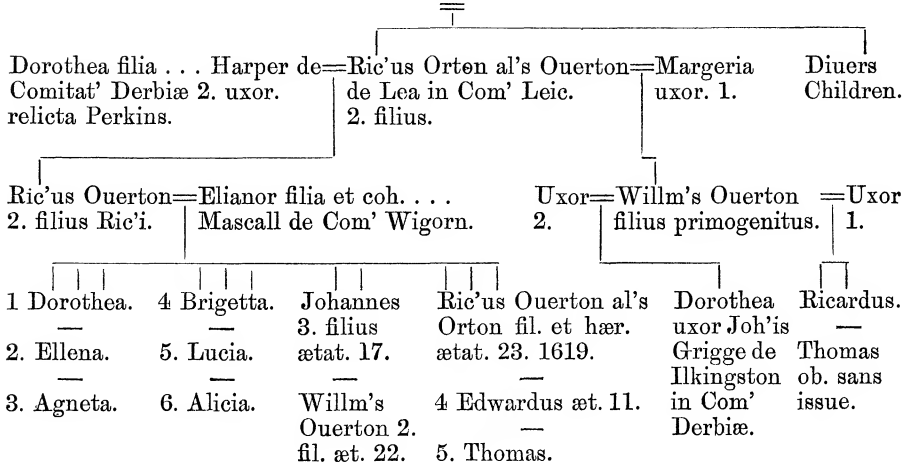

(Strelley.)

ARMS. *Paly of six argent and azure, in chief a mullet for difference.*

Nicholas Strelley a third sonne of the house of Strelley in Com' Derby.

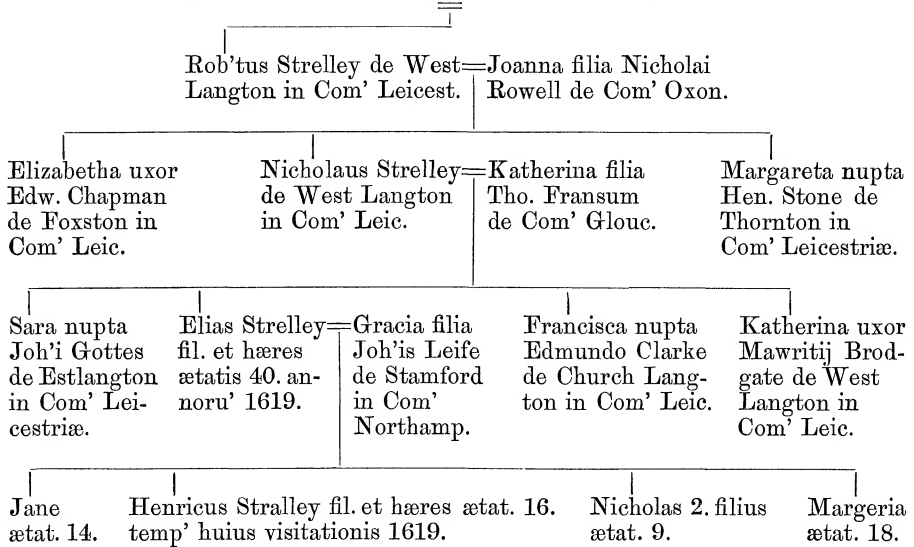
**(Vowe.)**

Willm's Vough de Halloughton in Com' Leic. = Margareta filia et hæ. Joh'is Mitton whose auncester married y^e Da. & hey. of Dester & Dester married the Da; & hey; of Hackluit. His office to be found in the Rolles for Halloughto'.

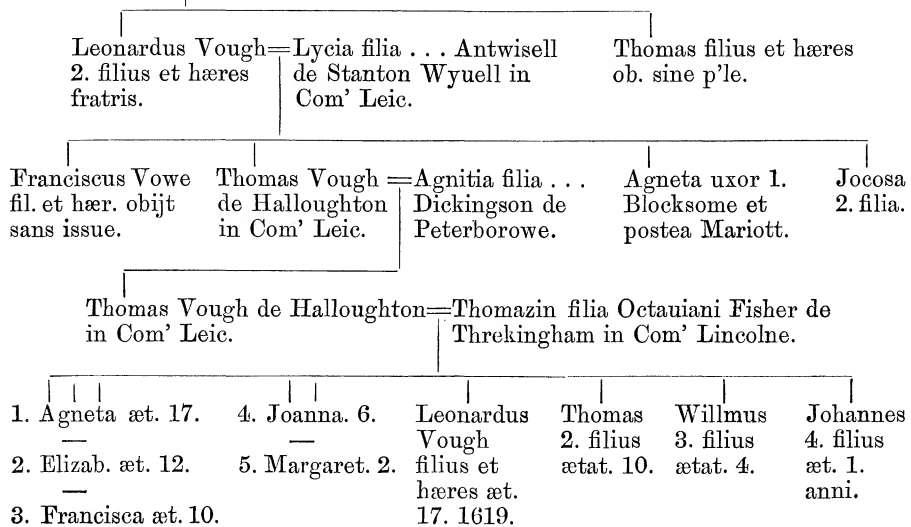

(Dixon.)

Joanna filia Cannon=Ricardus Dixon de Rolston in . . . Relicta . . . Brough de
de Com' Essex. Com' Leic. temp. H. 8. Brough in Com' Leic.

Friswold ob. sans issue. — Audria uxor . . . Astwell de Com' Northamp.	Margeria nupta . . . Sharpe de Comit' Rutland. — Margareta uxor . . . Dent de Hallaton in Com' Leic.	Willm's Dix- son de Rols- ton in Com' Leic.	=Margareta filia . . . Howe relictā . . . Bedell de Com' North- amp.	Ricardus Dixon 2. fil. ob. s. p. — Dorothea uxor Bedell de Com' Northamp.
--	---	--	---	--

Dorothea nupta Will'o Euerard de Barleston in Com' Leic.	Oliuerus Dixon de Kethrop in Com' Leic. 2. fil. = Anna filia Nic'i Armstrong de Desford in Comit' Leic.	Willm's Dixon de Rolston in Comit' Leic. = Anna filia Edw. Dudley de Clap- ton in Com' Northamp.	Johannes Dixon de Skrosbie in Com' Lincolne 3. filius. = Maria filia Joh'is Brian de Bulling- brooke in Comitāt' Lincoln.
---	--	---	--

1 Maria. — 2. Ruth.	3 Agneta. — 4. Joanna.	Ric'us Dixon fil. et hæres ætat. 18. — Oliuerus Dixon 2. fil. ætat. 3.	Joh'es Dixon fil. et hæres ætat. 15. 1619.	Jone uxor Rob'ti Busby. — Margeria 2. fil. ætat. 9.
---------------------------	------------------------------	--	---	---

(Allen.)

Anthוניus Allen de Marfeild in Com' Leic.

Anthוניus Allen de Marfeild=Anna filia Edwardi Deepcup de
in Com' Leic. Rockingham in Com' Leic.

2. Georgius. — 3. Edwardus. — 4. Henricus.	Willm's Allen de= Burrow in Comit' Leic. fil. et hæres ætat. 26. 1619.	=Katherina fil. Hen. Dilling- ham de Deane in Com' Leic.	5. Anthonius. — 6. Ricardus. — 7. Thomas.	1 Maria. — 2. Anna. — 3. Jocosa.
Thomas fil. et hæres æt. 3 annoru' 1622.	Briget ætat. 2. 1619.	Anna 2. filia æt. unius anni 1622.		

(Lany.)

ARMS. *Quarterly*:—1. *Argent, on a bend between two fleurs-de-lis gules a lion passant or.* 2. *Argent, a chevron engrailed between three cinquefoils gules, on a chief of the last a lion passant or.* 3. *Gules, a crescent ermine within an orle of martlets or.*

CREST. *A mermaid (untinctured), wreathed argent and azure, holding in dexter hand a hawk's bell of the first attached to a string vert, at the end a tassel silver.*

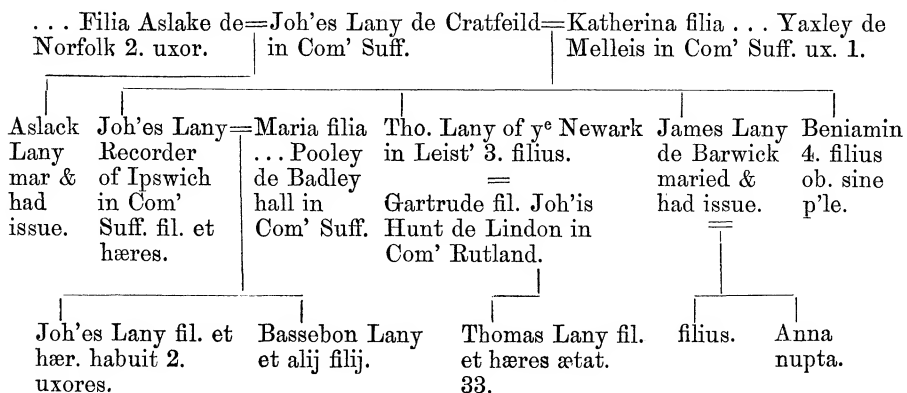
**(Hartop.)**

ARMS. *Sable, a chevron between three otters passant argent.*

CREST. *Out of a coronet or, a demi-pelican with wings endorsed argent, vulning herself gules.*

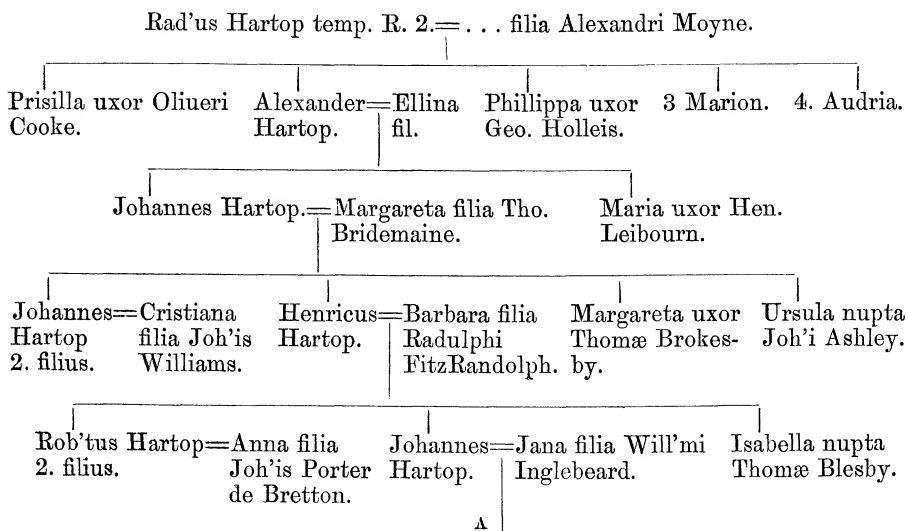

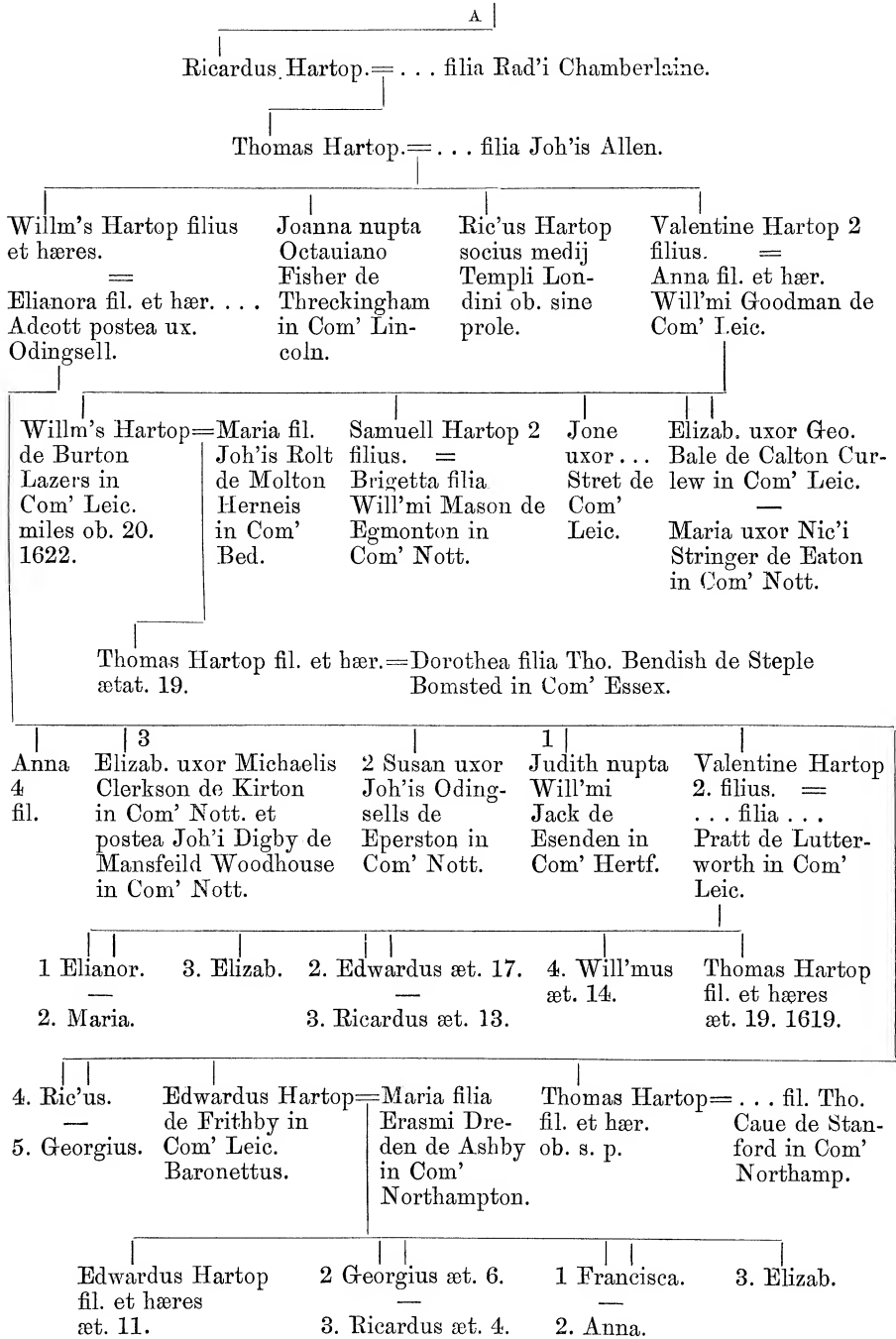

(Perin.)

ARMS. *Argent, on a chevron sable between three pine-apples slipped, reversed vert, as many leopards' faces of the field.*

Gilbertus Perin de Com' Salop. = Elizab. filia . . . Scrimshaw de Com' Salopiæ.

Thomas Perin de Ashby = Katherina filia Tho. Parret de Ashby
de la Zouch. de la Zouch.

Thomas Perin de Ashby de la = Anna filia Radulphi Potter de
Zouch ætat. 34. Lichfeild in Com' Staff.

Thomas Perin filius et
hæres ætat. 9.
annoru' 1619.

2 Elizabetha 6.
3. Sara ætat. 3.

1 Katherina 8.
4. Maria 3 menses.

(Ashton.)

ARMS (*Field untingured*) *a mullet sable charged with an annulet or, in dexter chief a crescent gules for difference.*

CREST. *A boar's head argent, charged with a crescent for difference.*

Peter Ashton de olde Weston in Com' Hunt.

Thomas Ashton filius et hæres.	Peter Ashton Doctor Theologiæ et rector Eccl'ie de Houghton et Witton in Comit' Hunt. et unus Magistroru' Cancellariæ temp. H. 8. 2 filius.	Gilbertus Ashton de olde Weston in Com' Hunt. 4 fil. =	John Ashton Doctor Theologiæ et rector Eccl'ie de Shitlington in Com' Bedford 3. filius.	Ric'us Ashton de Shitlington in Com' Bedf. 5. filius.
--------------------------------	---	--	--	---

Edwardus Ashton fil. et hæres.

Robtus 2. filius.

Johannes 3. filius.

Peter Ashton fil. et hæres D'ns de olde Weston & Patron of 3. Churches.

A

= Lettice filia Tho. Spilware de Leighton Bromswold in Com' Hunt.

Gilbertus 3 filius duxit Filiam . . . Croper de Buckworth in Comitatu Hunting.

B

Thomas Ashton 2. filius duxit Agnetam filiam . . . Laddes de Leighton Bromswold in Com' Hunt.

c

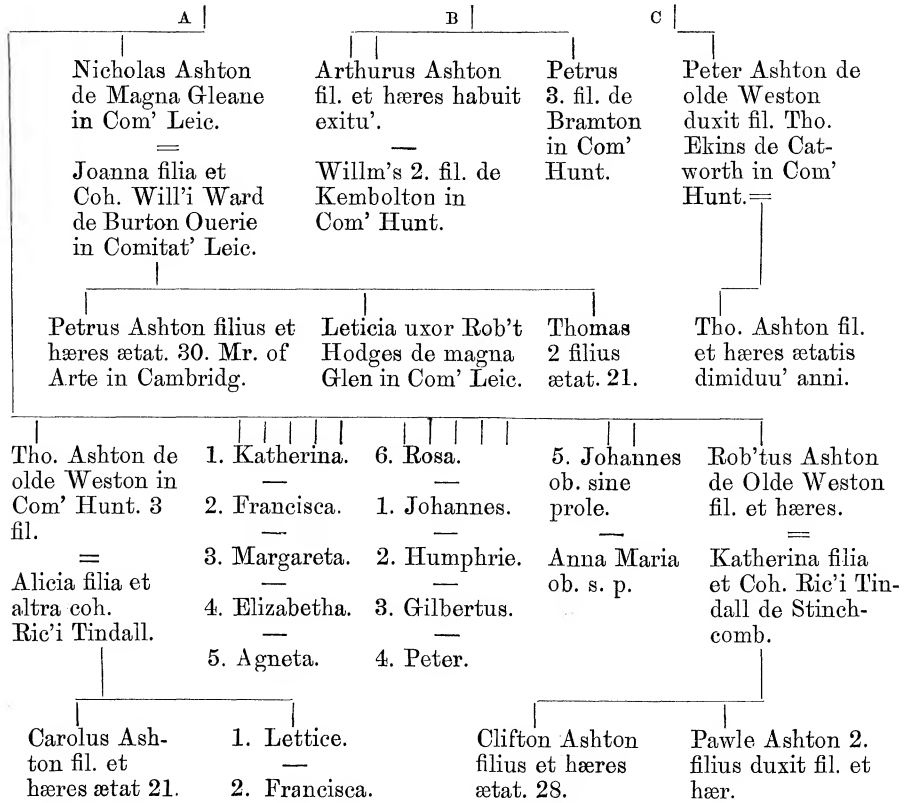

(Digby.)

... filia Carl- = Willm's Digbie de = ... filia ... Dixwell
ton 2. uxor. Welby in Com' Leic. | de Com' Warwick.

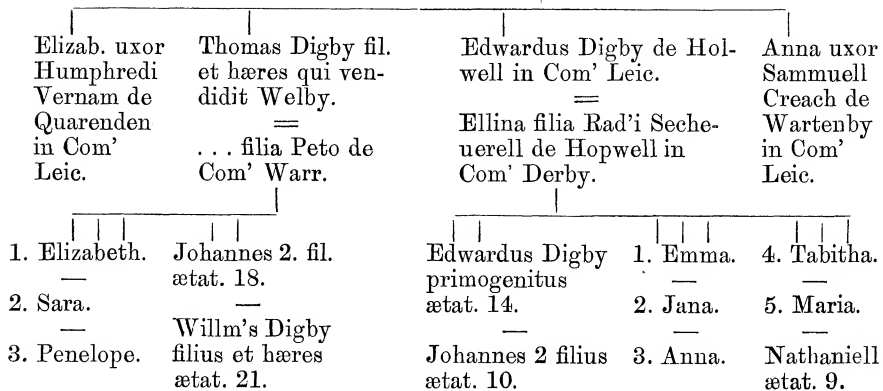

(Wase.)

ARMS. *Argent, on a chevron sable between three garbs vert, banded or, as many étoiles of the field.*

CREST. *Out of clouds proper issuing rays or, thereon a dexter arm embowed in armour argent, garnished of the first, holding by the point a demi battle-axe erect of the second.*

John Wase de London Merchant temp. H. 6.

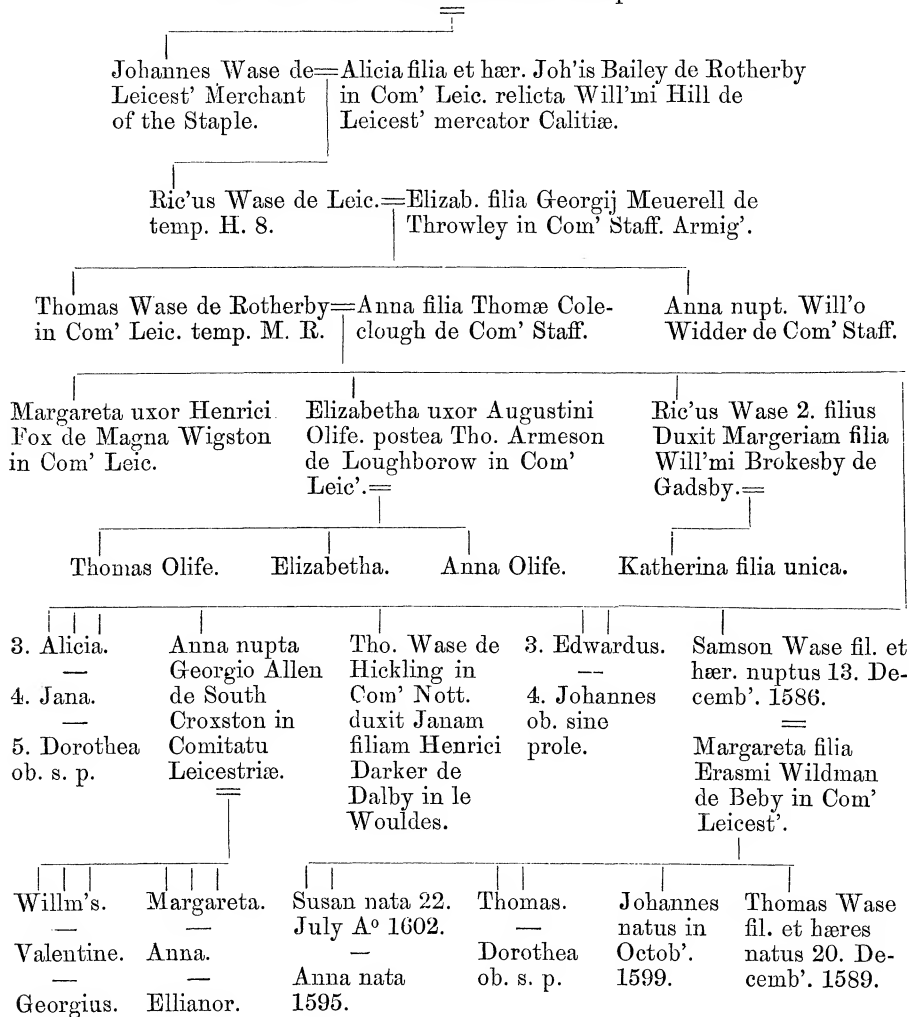

(Brookesby.)

ARMS. *Barry of six nebulée argent and sable, a canton gules.*

CREST. *A boar's head couped at the neck, bristled and tusked or.*

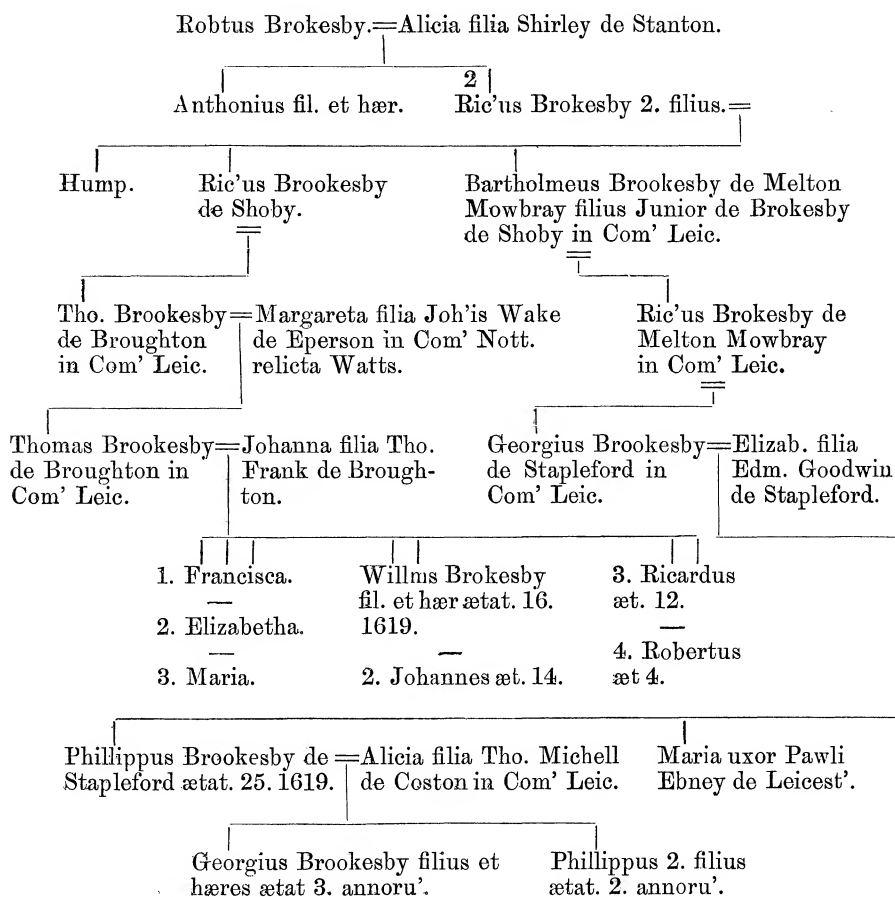

(Farrent.)

Lawrentius Farrent de Moulton in Com' Hunt.=Elizab. filia Adæ D'ni Lumley.

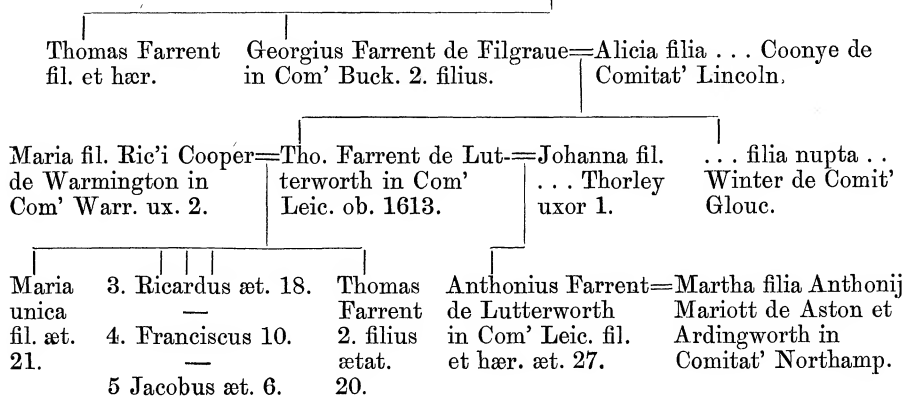
**(Rudiard.)**

ARMS. *Argent, treillé sable, on a canton gules a rose or.*

Rad'us Rudiard de Rudiard in Com' Staff.

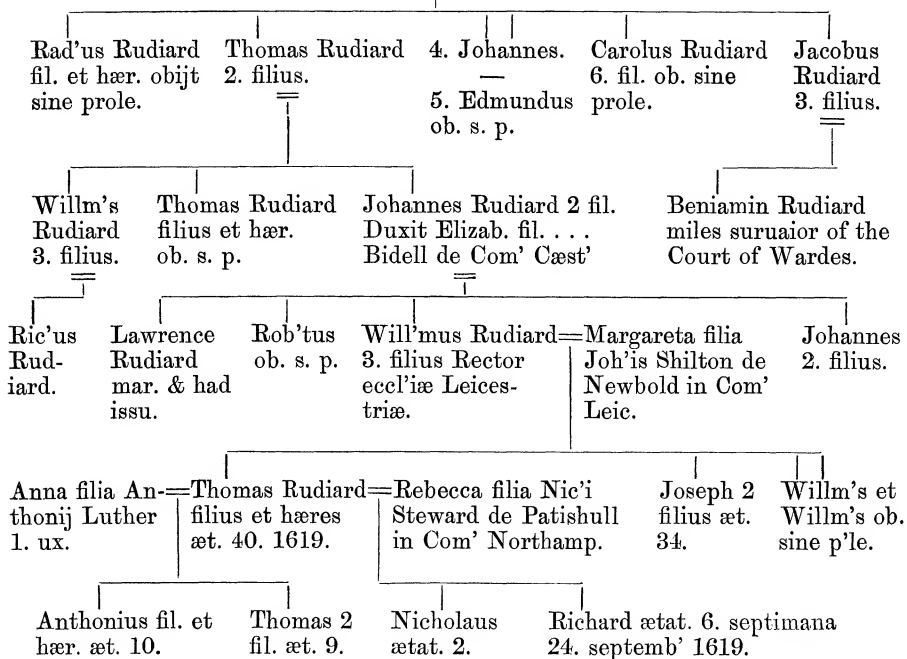

(Roberts.)

ARMS. *Quarterly:—1. Argent, three pheons sable, on a chief of the last a greyhound courant of the field, collared gules. 2. Per fess argent and gules, a pale counterchanged, on the first, three demi-lions rampant couped sable, crowned or. 3. Argent, on a fess sable three fleurs-de-lis or.*

ANOTHER. *The same, with a crescent for difference; impaling argent, two bars, and in chief a lion passant gules.*

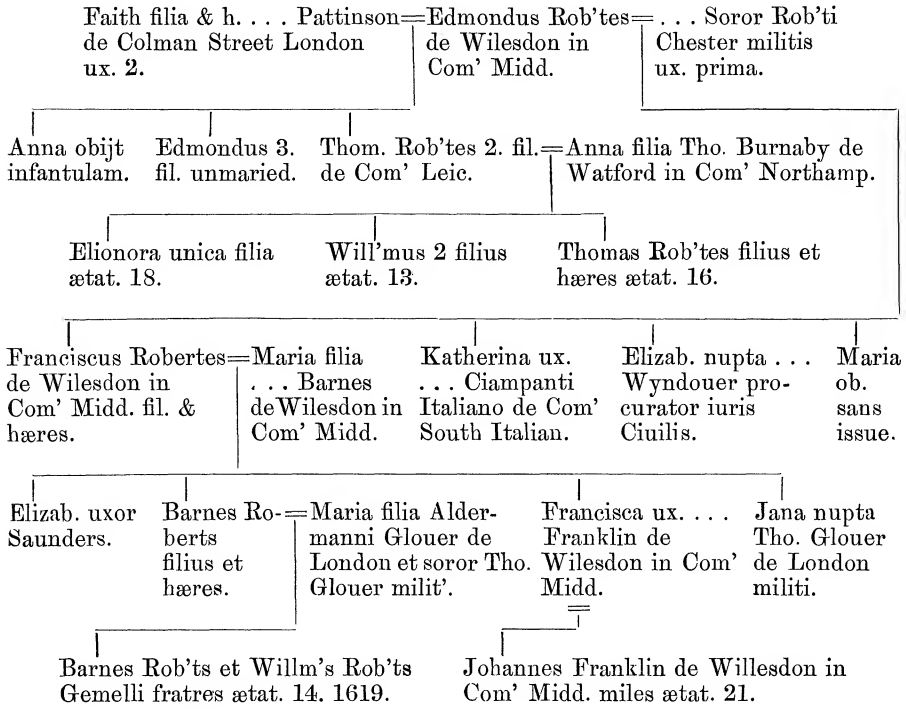

(Sherman.)

ARMS. *Or, a lion rampant sable, charged on the shoulder with an annulet for difference between three oak-leaves vert.*

CREST. *A sea-lion séjant argent, guttée de poix, finned or.*

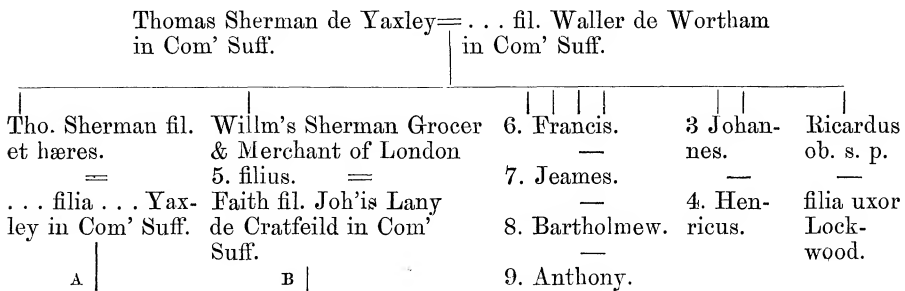

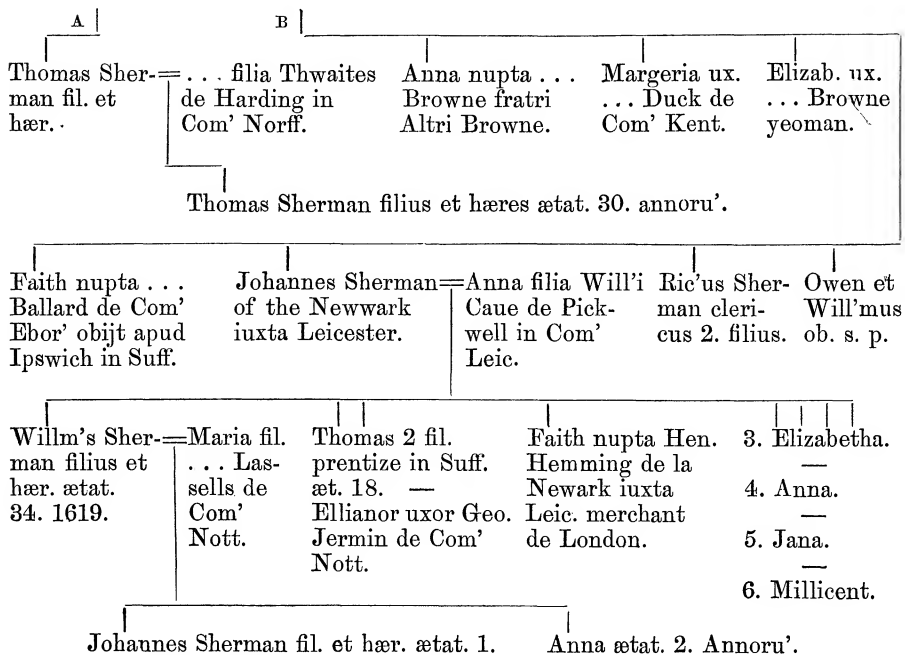

(Hall.)

ARMS. *Argent, three talbots' heads erased sable between nine cross crosslets azure.*
CREST. *A dragon's head coupéd azure, collared argent, charged with a crescent for difference.*

Anthonius Hall de Henwick in Comitatu' Wigor.

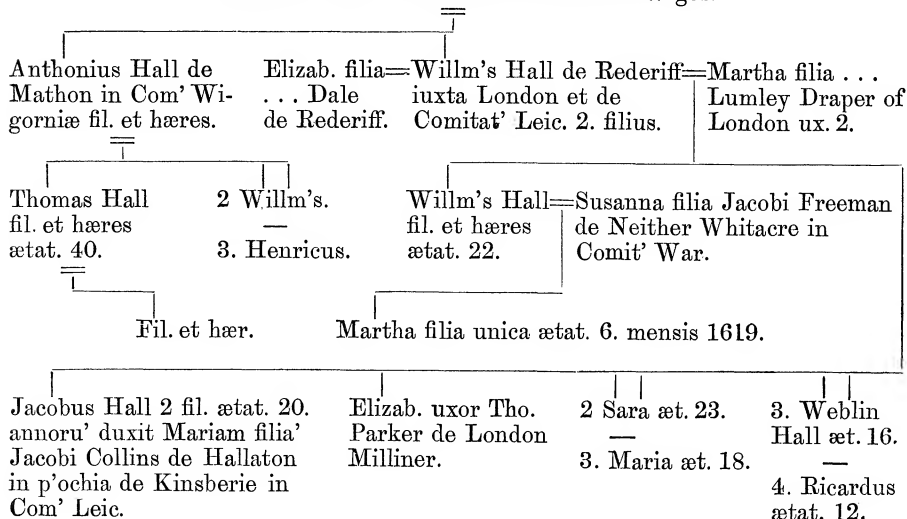

(Griffith.)

ARMS. *Per chevron argent and gules, three stags' heads caboshed counterchanged.*

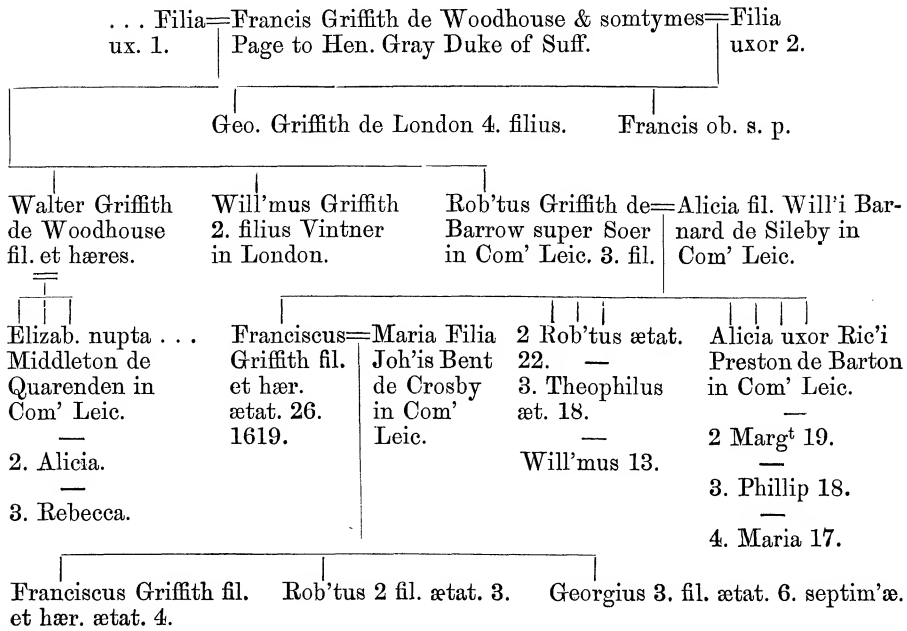

(Babington.)

ARMS. *Quarterly:—1. Argent, ten torteaux, four, three, two, and one, in chief a label of five points azure. 2. Azure, a cross stony or. 3. Argent, a fess vair azure and or, between three water bougets sable. 4. Or, a chevron gules, a canton ermine. 5. Azure semée of fleur-de-lis, a lion rampant or. 6. Gules, a lion rampant vair. 7. Argent, a bend componé gules and sable, cotised of the first. 8. Sable, two lions passant in pale regardant argent.*

CREST. *A demi-rere-mouse in pale affrontée, displayed gules. On the dexter side is written "The Crest is a demi Dragon gu." On the sinister against the wings, "false."*

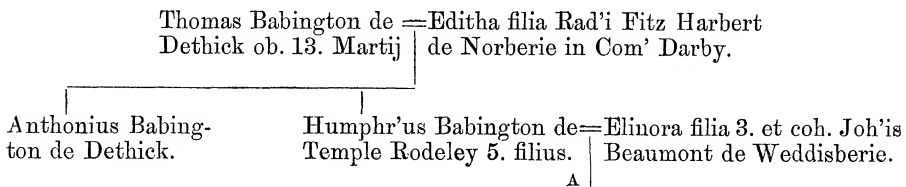

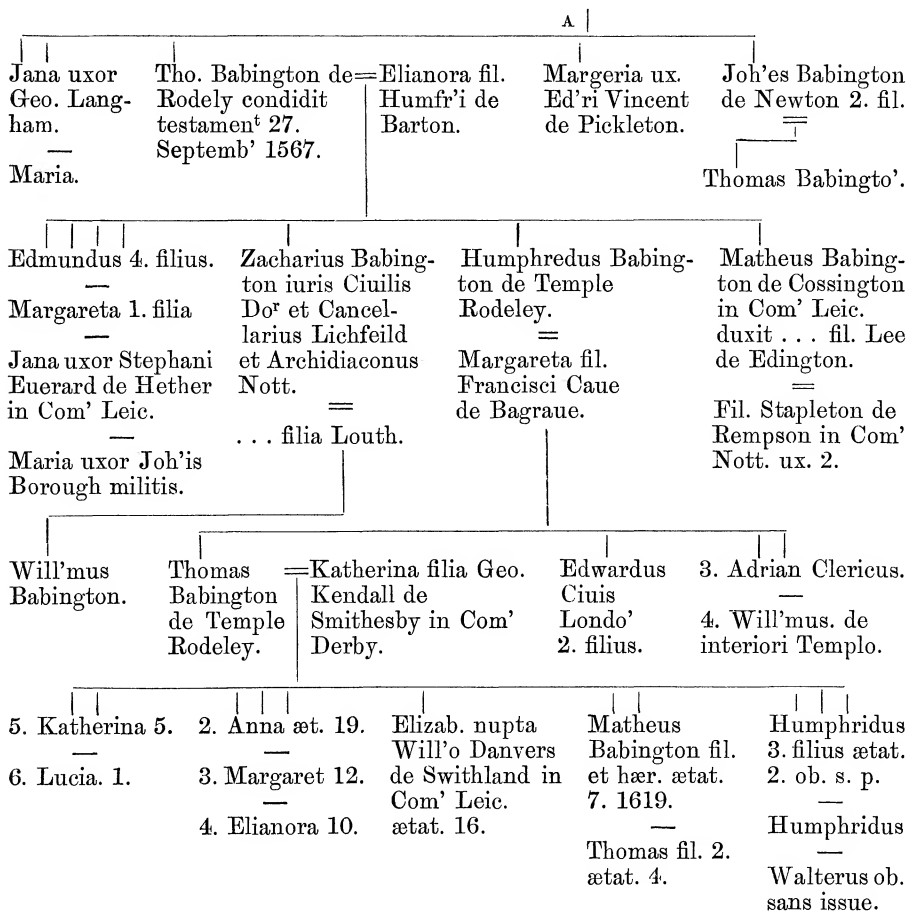

(Brett.)

ARMS. *Gules, a fess indented between six billets or.*

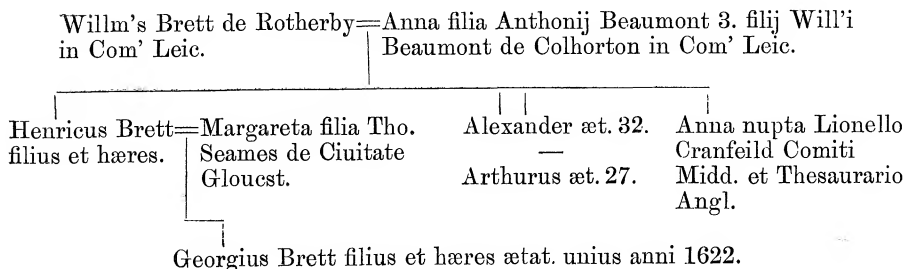

(Bery.)

ARMS. *Ermine, on a bend engrailed azure three fleurs-de-lis or, in chief a crescent gules for difference.*

... filia=Willm's Berie de Ashwell in Com' Rutland who=
uxor 2. Cam out of the house of Bery of Collaton in Com' Deuon. | ... filia Pickering de Com' Northamp. uxor. 1.

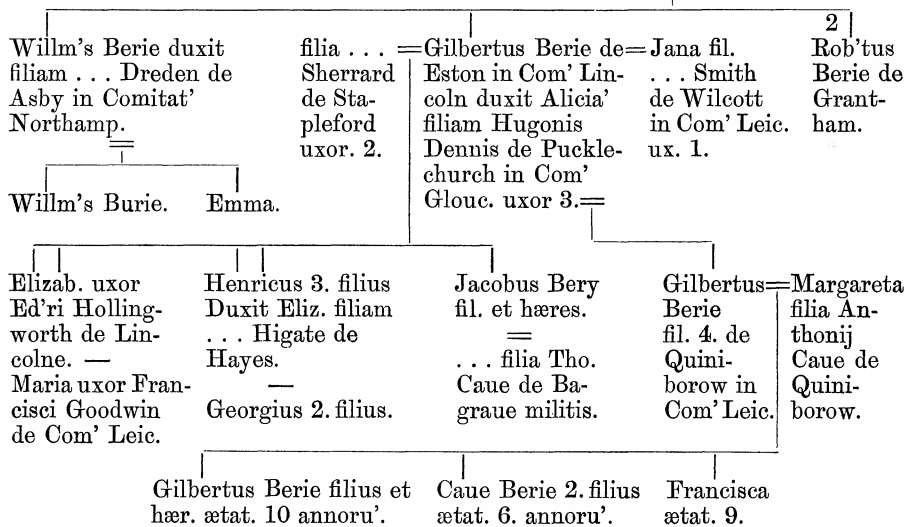

Facsimile Signatures of Leicestershire Gentry;
from the original loose papers of the Visitation of 1619. Harl. Miss 1195

Edm^d nd Cooz

William Coe

Symon Sandall William Moxto

William yfard & Gilbertson

Nath: Wolstings William Lawton

Ed. Swile & George Marshall

Fabile & Walter Endings

Alexander Oates & Charles Mosey

Edw Turner & George Mosey

Thomas Belgrave & Math. Mosey

Richard Mosey & Chisoldin

John Dawes & Isaac Cooke

Thomas Noble

William Allin

Thos: Lane & Co

Thos: Lane

~~Thos: Lane~~

Thos: Deryns

Thos: Stanley

Wm: Embury

Thos: Astor

Robt Breton

Thomas Brooksby

with Neate

Phillip Brooksby

Andrew Brown

Wm: Roberts

William Sutton

Thos: Sherman

~~Thos: Sherman~~

Nicholas Kelley

William Hatte

Thos: Wood

Francis Griffith

William Dixon

Thos: Babington

INDEX OF NAMES.

Names in *Italics* have their arms blazoned.
 ,, CAPITALS are the headings of pedigrees.
 ,, Brackets () are maiden names.
 ,, " [] are titles or surnames to titles.
 = signifies "married to a."

Abbot, Robert, 148.
 Dorothea (Whaley), 148.
 Abell, Alicia = Vincent, 79.
 — = Lichfeild, 79.
Abney, 153, 154.
 ABNEY, 153, 154.
 Anna (?), 154.
 Anna, 153.
 Anna = Beale, 153.
 Anna (Smith), 153.
 Audria (Howe), 153.
 Danettus, 154.
 Edmund, 154.
 Ellina = Glen, 153.
 Ellina, 153.
 Elizabetha, 154.
 Francis, 154.
 George, 81, 153, 154.
 James, 153, 154, 177.
 Johanne, 154.
 John, 153, 154.
 Katherina (Ludlow), 154.
 Katherina = Warde al's Farmour, 177.
 Katherina, 154.
 Maria (Brookesby), 154.
 Maria = Colly, 154.
 Mary = Vincent, 81.
 Paul, 154.
 Robert, 153, 154.
 Thomas, 153, 154.
 Walter, 154.
 — = Vincent, 51.
 Abraham, Johanna = Mulsho, 155.
 Ackworth, Elizab. (Purifoy), 35.
 William, 35.
 Acres, Lucia (Robertes), 118.
 Thomas, 118.
Acton, 113.
 Jane (Caldwall), 192.
 Joan = Noell, 113.
 John, 192.
 — (Robertes), 117.
 Acworth, Ann = Staresmore, 6.
 Adept, Elianora = Hartop, 9, 197.
 ,, = Odingsells, 9.

Agar, Anna = Alsop, 105.
 George, 105.
 John, 52.
 — = Draper, 52.
 — = Urswick, 52.
 Ailesbury, Mary = Hubert, 38.
 Thomas, 38.
 Alcock, Elizab. (Turvile), 55.
 Brigetta (Haselrigg), 16.
 John, 16.
Allen, 109.
 ALLEN, 109, 195.
 Agnes = Dannet, 51.
 Alexander, 109.
 Anna (Deepecup), 195.
 Anna (Wale), 109.
 Anna (Savill), 93.
 Anna (Wase), 200.
 Anna, 195.
 Anthony, 97, 195.
 Briget, 195.
 Christopher, 109.
 Edward, 195.
 Ellinora (Garret), 109.
 Elizabeth = Burdet, 109.
 Elizabeth (Warde), 83, 109.
 Elizabeth (Belgrave), 96.
 Francisca = Bodington, 109.
 Francisca (Charnells), 123.
 George, 195, 200.
 Henry, 195.
 Isabella = Cave, 120.
 James, 109.
 Jana (—?—), 109.
 Jane (Wigley), 97.
 Jocosa, 195.
 John, 9, 96, 109, 120, 184, 197.
 Katherina (Dillingham), 195.
 Katherina = Alsop, 185.
 Margareta (Moore), 109.
 Maria (Reven), 109.
 Maria, 195.
 Maria = Morton, 184.
 Mary = Smith, 66.
 Raph, 109.
 Richard, 195.
 Thomas, 83, 109, 195.
 Valentine, 93.
 William, 66, 109, 195.

ALLEN—*continued*.
 — (Warde), 83.
Alsop, 105.
 ALSOP, 105.
 Anna (Agar), 105.
 Charles, 105.
 Dorothea (Moleneux), 105.
 Elizaab. (Welsh), 105.
 Ellin = Arneston, 176.
 George, 105.
 Humphrey, 105.
 Isabella (Warner), 105.
 Jana, 105.
 John, 105.
 Katherina (Allen), 105.
 Margareta = Gregorie, 189.
 Maria (Cooper), 105.
 Maria (Spencer), 105.
 Maria, 105.
 Nicholas, 105.
 Thomas, 176.
 William, 105, 189.
 Andrea, William de Sto., 78.
 Maria (Pillington), 78.
 Andrewe, Francis (Belgrave), 69.
 Andrewes, Fabian, 94.
 Elizabeth (Cotes), 94.
 Katherina (Cave), 126.
 Katherin (Belgrave), 68.
 Richard, 68.
 Sir Thomas, 16.
 Thomas, 126.
 Ursula = Haselrigg, 16.
 Anjou, Charles d' [King of Sicily], 169.
 Anne Jana = Peck, 147.
 John, 147.
 Antwisell, Lycia = Vough, 194.
 Ap John, William, 119.
 Eliz. (Sturton), 119.
 Ap Rese, Anna (Brudnell), 143.
 Lodovicus, 143.
 Ap Rice, Jana (Dakins), 117.
 Thomas, 117.
Apleby, 11.
 APLEBY, 11.
 Alice = Hardwick, 11.
 Barbara, 11.
 Edmond, 11.

APLEBY—*continued.*

- Elizabeth (Langham), 11, 12.
Francis, 11.
George, 11.
Henricus, 11.
Jocosa (Curson), 11.
John, 11.
Nevill, 11.
Richard, 11.
Sir Edmond, 11.
Sir John, 11.
Sir William, 11.
Thomas, 11.
— (Pechet), 11.
Arden, Muriella = Charnells, 123.
Ardern, Matilda (Stafford), 23.
Thomas, 23.
Armeson, Eliz. (Wase), 200.
Thomas, 200.
Armeston, 176.
ARMESTON, 176.
Anna (Beck), 176.
Anna (Replingham), 176.
Ellin (Alsop), 176.
James, 176.
Peter, 176.
Thomas, 176.
William, 176.
Armstronge, Anna = Dixon, 195.
Ellin = Turvile, 55.
Francis, 119.
Francisca (Sturton), 119.
Gabriel, 91.
Hugh, 55.
Maria (Pilkington), 78.
Nicholas, 195.
Thomas, 170.
— = Beaumont, 170.
Arundell, E. of [Fitz-Alan], 169.
Elizab. (Dannet), 64.
John, 64.
Arwaker, Dorothy (Smith), 67.
Thomas, 67.
Ashbornham, John, 171.
Elizab. (Beaumont), 61, 171.
Sir John, 61.
Ashby, 13, 14, 60, 132.
ASHBY and ASHBIE, 13, 14, 132.
Agnes (Illingworth), 14.
Agnes (Poultney), 14.
Agnes = Brokesby, 14.
Anna = Teverey, 13, 132.
Anne (Beaumont), 14, 59, 60, 172.
Anne, 14.
Barbara = Ashby, 14.
Barbara (Ashby), 13, 132.
Bridget = Fox, 14.
Briget, 13, 132.
Charles, 13, 132.
Ciceley = Heirik, 14.
Dorothy = Parrlane, 13, 132.
Dorothy = Bradshaw, 13, 132, 161.
Dorothea, 132.
Dorothea (Minors), 60.
Elianor (Gedney), 13.
Elizabeth (—?—), 14.

ASHBY and ASHBIE—*continued.*

- Elizabeth = Penbery, 14.
Elizabeth = Naunton, 14.
Elizabeth (Tanfeild), 14.
Elizabeth = Warde, 83.
Elizabeth, 14.
Everard, 2, 14.
Francis, 14.
Frances = Throckmorton, 14.
George, 13, 14, 60, 132.
Henry, 13, 132.
Joyce = Sherard, 10.
Joyce = Pell, 13.
Jocosa = Sherard, 14.
Jocosa = Pell, 132.
John, 14.
Katherine (Brett), 14.
Katherine (Haselrigg), 15, 132.
Margery = Needham, 100.
Maria = Gedney, 132.
Mary (Band), 214.
Mary = Eaton, 14.
Mary = Eyton, 183.
Robert, 13, 14, 83, 132, 161.
Thomas, 10, 13, 14, 59, 60, 132, 172, 183.
Ursula, 14.
William, 13, 14, 60, 132.
— (Beaumont), 171.
— = Chambers, 52.
— (Curzon), 13, 132.
— = Skeffington, 13, 132.
— (Bennet), 13.
— (Digby), 14.
— = Sercole, 14.
— (Browne), 14.
— (Witterantes), 14.
— (Minors), 14.
Ashfeild, Elianor (Humphrey), 62.
Sir Edmond, 62.
Ashley, Dorothy, (Berford), 178.
Elizab. = Berford, 178.
John, 9.
Micheal, 178.
Thomas, 178.
Ursula (Hartop), 9.
Ashton, 198.
ASHTON, 198, 199.
Agnes (Ladder), 198.
Agneta, 199.
Alicia (Tindall), 199.
Arthur, 199.
Charles, 199.
Clifton, 199.
Edward, 198.
Elizabeth, 199.
Francisca, 199.
Gilbert, 198, 199.
Humphrie, 199.
Joanna (Ward), 199.
John, 25, 198, 199.
Katherina (Tindall), 198.
Katherina, 199.
Letlice (Spilware), 198.
Letice, 199.
Leticia = Hodges, 199.
Lucy = Brom, 25.
" = Shirley, 25.
Margareta, 199.

ASHTON—*continued.*

- Nicholas, 199.
Paul, 199.
Peter, 198, 199.
Richard, 198.
Robert, 198, 199.
Rosa, 199.
Thomas, 198, 199.
William, 199.
— (Croper), 198.
— (Ekins), 199.
Aslake = Larry, 196.
Asplane — = Noell, 114.
Astell, Ellinor = Savill, 93.
Astley, Jane = Lord Grey, 17, 74.
William, Lord 17, 74.
Aston, Ann, 85.
Anna = Everard, 114.
Elizab. (Tookey), 85.
Ellen (Pratt), 85.
Grissell (Latham), 85.
Hugh, 85.
Joanna (Ward), 83.
Peter, 83.
Thomas, 85.
Astwell, Audria (Dixon), 195.
Atmore, Agnes = Montague, 124.
Audley, Henry, Lord 65.
Lord 4.
Anne = Brooke, 65.
Hugo, 21.
Alicia = Nevill, 21.
Aungevile, Robert, 29.
Mabell (Bellers), 29.
Avery Gracia (Croft), 141.
Thomas, 141.
Ayott, Allen, 32.
Maria = Purifoy, 32.
Babington, 205.
BABINGTON, 205, 206.
Adrian, 120, 127, 206.
Anna, 206.
Anthony, 206.
Elianor, 206.
Elinor (Humphry), 62.
Elinora (Beaumont), 170, 205.
Elinora (Barton), 206.
Editha (Fitz Harbert), 205.
Edmond, 206.
Edward, 206.
Elizabeth = Nevill, 21.
Elizabeth = Danvers, 87, 206.
Humphrey, 81, 127, 170, 205, 206.
Jane = Everard, 206, 175.
Jane = Langham, 206.
Jana = Turvile, 55.
Joanna (Beaumont), 170.
John, 206, 78.
Katherina (Kendall), 206.
Katherine, 206.
Lucia, 206.
Margareta (Cave), 120, 127, 206.
Margaret = Vincent, 81.
Margeria = Vincent, 206.
Margeria = Pilkington, 78.

- BABINGTON**—*continued*.
 Mary = Vincent, 51.
 Margareta, 206.
 Maria = Borough, 206.
 Mathew, 206.
 Thomas, 51, 55, 62, 87, 170,
 175, 205, 206.
 Walter, 206.
 William, 21, 170, 206.
 Zacharias, 206.
 — (Langham), 12.
 — (Lee), 206.
 — (Louth), 206.
 — (Stapleton), 206.
 Badger, Baghot al's, 150.
Baghot, 150.
BAGHOT, 150, 151.
 Alianora = Staver, 150.
 Alicia (Martin), 150.
 Amicia = Pert, 150.
 Anna, 151.
 Beatrice (Malory), 59.
 Charles, 150, 151.
 Edmond, 151.
 Edward, 150.
 Egidius, 150.
 Elizab. = White, 151.
 Francis, 151.
 George, 150.
 Katherina (Hide), 151.
 Margareta = White, 151.
 Maria (Barow), 150.
 Richard, 150, 151.
 Rosa (Person), 150.
 Susanna (Fineux), 151.
 Thomas, 150, 151.
 William, 150, 151.
 Winifred (Rayman), 151.
 Bagshaw, Edward, 187.
 Maria (Heminges), 187.
 Maria = Nicolls, 187.
 Baiard — = Smith, 66.
 „ = Wye, 66.
 Bailes — = Gore, 85.
 Bailey Alicia = Wase, 200.
 Alicia = Hill, 200.
 Anna (Mulsho), 155.
 John, 200.
 William, 155.
Bainbrig or *Baynbrige*, 181,
 190.
BAINBRIG and **BAYN-**
BRIGE, 181, 190.
 Abigall, 190.
 Abraham, 191.
 Alicia = Hunt, 181.
 Alicia (—?—), 190.
 Alicia (Palmer), 190.
 Anna (Lawe), 182.
 Anna (Jackson), 182.
 Anna (Everard), 190.
 Anna = Westwood, 191.
 Anna, 182.
 Barnaby, 182.
 Berseba, 190.
 Edward, 191.
 Elizabeth (Charde), 181.
 Elizabeth = Stanford, 160,
 181.
 Elizabeth = Toringham,
 181.
 Elizabeth (Chare), 190.
- BAINBRIG** and **BAYNBRIGE**—*cont.*
 Elizabeth (Smith), 191.
 Elizabeth, 182.
 Ellina, 191.
 Ester = Bainbrig, 182.
 Henry, 191.
 Hester, 190.
 Isabella (Milgate), 181.
 John, 181, 182, 190, 191.
 Joseph, 190.
 Lucia (Stacy), 191.
 Maria = Lawe, 182.
 Maria (Watts), 191.
 Maria (Willnael), 191.
 Margareta, 190.
 Martha, 190.
 Mary, 182.
 Mathew, 190.
 Nathaniell, 191.
 Philipp, 182.
 Rachell = Corbison, 190.
 Rebecca, 191.
 Robert, 181, 190.
 Samuell, 191.
 Sara, 190.
 Sara = Ducket, 182.
 Sara = Robinson, 182.
 Susan, 182.
 Susanna, 190.
 Thomas, 181, 182, 191.
 William, 160, 181, 182, 190.
 Bainham, Robert, 117.
 — = Robertes, 117.
 Baker, John, 79, 189.
 Francisca = Vincent, 79.
 Francisca = Gregorie, 189.
Bale, 141.
BALÉ, 141, 142.
 Alicia (Couper), 141.
 Anthony, 141.
 Dorothea, 141.
 Edmund, 118, 141.
 Edward, 141.
 Elizab. (Hartop), 9, 141, 142,
 197.
 Elizabeth (Chippindale), 142.
 Elizabetha, 141.
 Emma (Halford), 142, 144.
 Emma, 142.
 Francis, 141, 142.
 Francisca (Brocas), 141,
 Francisca = Roberts, 118, 142,
 Francisca, 141.
 George, 9, 118, 141, 142, 197.
 Johanna (Pettie), 141.
 Joanna (Gamble), 141.
 John, 141, 142, 144.
 Jocosa = Robertes, 118, 141.
 Jocosa, 141.
 Katherina = Saunderson,
 141.
 Margareta (Manning), 141.
 Richard, 141.
 Robert, 141.
 Sir John, 141.
 Valentine, 142.
 William, 141, 142.
 Ballard, Thomas, 160.
 Katherine (Stanford), 160.
 Faith (Sherman), 204.
 Band, Mary = Ashby, 2, 14.
 Mary = Berkley, 2, 14.
- Band, Robert, 2, 14.
 Bandon, Alicia (Skeffington),
 112.
Banister, 164.
BANISTER, 164.
 Anna (Fitz Harbert), 165.
 Anna (Cox), 165.
 Anna (Barton), 165.
 Anna, Geary, 165.
 Anna (Hall), 165.
 Daniell, 165.
 Dorothea (Hardwick), 165.
 Elizabeth (Jaques), 165.
 Elizabeth (Temple), 165, 168.
 Elizabeth = Stretford, 165.
 Elizabeth, 165.
 Hellen (—?—), 165.
 Henry, 165.
 Jane = Corbett, 165, 177.
 John, 165.
 Margareta (Hichinson), 164.
 Nicholas, 165.
 Phillip, 164.
 Thomas, 164, 165.
 William, 164, 165.
BANKES, 150.
 Alicia (Sco t), 150.
 Christopher, 150.
 Edward, 150.
 Elizabetha (Forster), 150.
 Elizabeth, 150.
 Lucas, 150.
 Margareta (Starkey), 150.
 Margareta = Harris, 150.
 Maria (Hall), 150.
 Richard, 150.
 Thomas, 150.
 William, 150.
 Bantock — = Wincoll, 156.
 Barber, Alicia (Walcott), 86.
 John, 86.
 Bardolph, Phillip, 170.
 Elizab. = Beaumont, 170.
 Barfoote, John, 86.
 Jocosa (Danvers), 86.
 Barford, Arthur, 87.
 Dorothea (Danvers), 87.
 Barkeley, Emma (Brokesby),
 49.
 Laurence, 2.
 Thomas, 49.
 Barker, Dorothea (Dixie), 116.
 Katherina (Vincent), 81.
 William, 81, 205.
 Barkley, Sir Morice, 49.
 Barnack, Elianor (Borough),
 38.
 Jone = Hubert, 38.
 Marg. = Bellers, 29.
 Walter, 38.
 — (Woodford), 38.
 Barnard, Alicia = Griffith, 205.
 Dorothea (Cave), 127.
 John, 127.
 William, 205.
 Barnby, John, 102.
 Sara (Lawrence), 102.
 Barnes, John, 52.
 Maria = Robertes, 203.
 Mary (Chambers), 52.
 Barnfeld, Walter, 91.
 Margaret = Yarde, 91.

- Barnham, Benedict, 66.
 Barnham, Dorothy (Smith), 66.
 Baroden, Launcelott, 102.
 Isabella = Laurence, 102.
 Barow, Maria = Baghot, 150.
 Richard, 150.
Barret, 107.
 BARRET, 107.
 Anna (Leake), 107.
 Dorothea = Reynes, 107.
 Dorothea, 107.
 Elizab. = Fox, 107.
 Jocosia (Reynes), 107.
 Johanna = Halford, 144.
 Juditha (Bowier), 107.
 Judith, 107.
 Margareta = Bothom, 107.
 Margareta (Laser), 107.
 Richard, 107.
 Thomas, 107.
 William, 107.
 — = Marston, 101.
 Barsby, Jocosia = Cheselden, 107.
 Barton, Alicia = Ward, 83.
 Anna = Banister, 165.
 Elinora = Babington, 206.
 Humphrey, 206.
 Raph, 165.
 William, 83.
 Bartram, Lord of Mitford, 21.
 Barwell, Elizab. (Croft), 140.
 Grey, de, 17.
 Hester (Salisberie), 185.
 Isabella = Temple, 167.
 John, 140, 185.
 William, 167.
 Baskerville, Edward, 42.
 Elinora = Purifoy, 37.
 Grace = Gee, 180.
 John, 37, 42.
 Margaret, 42.
 Mary (Winter), 42.
 Thomas, 180.
 Ursula, 42.
Basset, 12, 50.
 Basset, Alicia = Mutton, 58, 80.
 Isabella = Shirley, 25.
 Johanna = Shirley, 25.
 Katherina = Pilkington, 78.
 Matilda = Grey, 74.
 Margaret = Bothom, 165.
 Mary = Beaumont, 60, 170.
 Ralph, 25, 58.
 Ralph, Lord 74.
 Sir William, 60.
 Thomas, 25.
 William, 78, 165, 170.
 Bassingham — = Dixie, 116.
 Bate, Jane (Turvile), 55.
 Bateman, Margaret = Neele, 46.
Baynes, 1.
 Baynes, Francis = Cater, 1.
 Beale, Edward, 153.
 Anna (Abney), 153.
 Beardman, George, 149.
 Barbara (Fox), 149.
 Beauchamp, Anna, 104.
 James, 104.
 Jana (Ruding), 104.
Beaumont, 60, 169.
 BEAUMONT and BEAUMOND, 60, 61, 169, 170, 171, 172.
 Anthony, 30, 60, 170, 206.
 Anna = Ashbye, 14, 59, 60, 172.
 Anna (Peirpoint), 60, 172.
 Anna (Saunders), 60, 171.
 Anne = Dillon, 61, 171.
 Anne, 61, 171.
 Anna (Harecourt), 170.
 Anna = Brett, 171, 206.
 Averia = Findern, 171.
 Barbara (Faunt), 172.
 Barbara, 172.
 Christopher, 172.
 Colletta (Clerke), 60, 170.
 Cicilia = Lord Botreux, 169.
 Dorothy = Rigmeden, 60, 172.
 Dorothea = Cumberford, 170.
 Dorothea = Hill, 171.
 Edward, 60, 172.
 Elinor, 61, 169, 170, 171, 172.
 Elinora (Borenis), 170.
 Elinora = Babington, 170, 205.
 Elizabeth (Hastings), 60, 172.
 Elizab. = Will. L^d Vaux, 60, 172.
 Elizab., 60, 61, 170, 171.
 Elizabeth (Bardolph), 170.
 Elizab. = Ashbornham, 61, 171.
 Elizabetha (Turpen), 61, 171.
 Elizabeth (Willoughby), 169.
 Elizab. (Brasbrig), 43, 172.
 Elizab. (Leois), 171.
 Elizabeth (Sabcott), 171.
 Elizabeth (Suliard), 172.
 Elizab. (Fortescue), 172.
 Francis, 43, 60, 61, 171, 172.
 Francisca = Dixie, 61, 116, 171.
 Frances, 61.
 Farnham, 61, 171.
 George, 59, 60, 170, 172.
 Gervaise, 172.
 Havise (Mutton), 59.
 Henry, 60, 61, 169, 170, 171, 172.
 Huntingdon, 61, 171.
 Isabell = Snowse, 61.
 Isabell = Snowsell, 171.
 Isabella (Dutton), 60, 172.
 James, 170.
 Jane = Brookesbie, 60, 172.
 Jane, 61, 171.
 Jane = Temple, 61, 171.
 Joane (Pauncefoote), 60, 170.
 Johanna (Dercy), 170.
 Johanna (Stafford), 170.
 Joanna = Babington, 170.
 Joanna (Pauncefoote), 170.
 John, 14, 59, 60, 61, 169, 172, 205.
 John de, 169.
 Katherin (Farnham), 61, 171.
 Katherina (Everingham), 169.
- BEAUMONT and BEAUMOND—*cont.*
 Katherina = Berkley, 3.
 Katherin, 61, 170, 171, 172.
 Margaret, 60, 170.
 Margeria, 170.
 Maria, 61, 171, 172.
 Maria = Storey, 172.
 Mary (Bassett), 60, 170.
 Mary = Paramour, 61, 171.
 Mary = Compton, 30, 60, 171.
 Mary = Reyner, 30, 60, 171.
 Mary = Villers, 30, 60, 171.
 Nicholas, 3, 60, 171.
 Phillippa (Marward), 169.
 Richard, 60.
 Robert, 61, 169, 170, 171.
 Sapcott, 61, 171.
 Sir Henry, 61, 171.
 Sir Thomas, 61, 171.
 Thomas, 46, 59, 60, 116, 169, 170.
 Thomazin (Mutton), 59, 60.
 Viscount, 169, 170.
 William, 60, 61, 172, 206.
 — (Armstrong), 170.
 — (Leventhorp), 170.
 — (Lovell), 170.
 — (Motton), 170.
 — (Leigh), 170.
 — = Maxwell, 171.
 — (Yore), 172.
 Beck, Anna = Armeston, 176.
 Maria (Sanderson), 119.
 Susanna (Cowper), 152.
 Peter, 176.
 William, 119, 152.
 Bedell, Dorothea (Dixon), 195.
 Brigetta = Dixy, 116.
 — (Howe), 195.
 William, 116.
 Bedford, John, 51.
 Elizab. (Dannet), 51.
 al's Sandy, 51.
Belgrave, 67, 95.
 BELGRAVE, 67, 68, 69, 95, 96.
 Ambrose, 67, 69.
 Anna, 67, 69.
 Anne = Corbett, 68.
 Anna = Stroughton, 96.
 Benjamin, 69.
 Christopher, 96.
 Dorothea (Saunders), 67.
 Dorothy = Saunders, 68.
 Dorothy = Cave, 68.
 Dorothy = Ravens, 68.
 Dorothy = Goistock, 68.
 Edward, 69.
 Elizabeth, 67, 69.
 Elizabeth (Shelton), 68, 96.
 Elizabeth = Allen, 96.
 Elizabeth, 96.
 Ellianor, 96.
 Francis, 67, 69.
 Francis = Andrewe, 69.
 Francisca, 96.
 George, 67, 68, 69, 77, 96.
 Hugh, 68.
 Hugo, 95.
 Huntington, 69.
 Isabell (Sandon), 68, 96.

BELGRAVE—*continued.*

Isabella (Skeffington), 8, 96, 112.
 James, 96.
 Jane (Stoughton), 69.
 Jane, 69.
 Joane (Swyke), 67, 68, 69.
 Johanna (Fa nham), 67, 77.
 John, 67, 68, 69, 95, 96.
 Katherine (Glene), 68, 96.
 Katherin = Andrewes, 68.
 Katherin (Knolles), 69.
 Laurence, 68, 95.
 Lucretia, 69.
 Margaret (Belgrave), 68, 95.
 Margaret (Willoughby), 68, 96.
 Margaret (Cotton), 68, 96.
 Margaret = Eyre, 69.
 Margareta (Oliver), 96.
 Margareta = Horneblow, 96.
 Margaret, 67.
 Margerie, 67, 69.
 Maria (Chauntrell), 67, 68.
 Maria = Sturgis, 96.
 Maria = Palmer, 96.
 Maria, 67, 69, 96.
 Peter, 68, 95.
 Prudentia (Norton), 96.
 Prudentia, 96.
 Richard, 68, 96.
 Robert, 67, 69, 96.
 Roger, 68, 95.
 Ruth, 69.
 Sedwina (Turpen), 96.
 Susan (Shipton), 68, 95.
 Thomas, 96.
 William, 68, 96.
 — (Poultney), 96.
 — (Wilson), 69.
Belknap, 64.
 Belknap, Sir Edward, 64.
 Mary = Dannat, 64.
 Bell, Luna (Skevington), 8.
 Lucia (Skevington), 112.
 John, 136.
 Sense (Wilcocks), 136.
 Bellamont — = Lord Botreux, 72.
 Bellengham, Thomas, 26.
 Jane = Shirley, 26.
 Bellers, Agatha (Vichan), 29.
 Elizabeth (Sutton), 30.
 Emma (Foleville), 29.
 Ellin = Ruskin, 30.
 James, 29.
 Joane = Villers, 30.
 Jane = Digby, 40.
 John, 30.
 Mabell (Aungeville), 29.
 Margaret (Barnack), 29.
 Margaret, 30.
 Mary (Purifoy), 37.
 Mary = Billne, 30.
 Richard, 29.
 Sir Hamon, 29.
 Sir James, 40.
 Sir Richard, 29.
 Sir Samson de, 29.
 William, 29, 162.
 — = Roskin, 75, 186.

Bellomonte, Alianora (Plantagenet), 169.
 John de, 169.
 Henry de [Bp. of Durham], 169.
 Ludovicus de, 169.
 Bellson, Augustine, 130.
 Joanne = Thame, 130.
 Belmeg, John, 64.
 Agnes = Dannet, 64.
 Bendish or Bendage.
 Thomas, 8, 112, 197.
 Dorothea (Hartop), 197.
 Joyce (Skevington), 8, 112.
 Bendlowes, Clara (Smith), 146.
 Bennet — = Ashby, 13.
 BENT, 158, 159.
 Adrian, 151, 158.
 Agneta (Marsh), 158.
 Agneta (Clarke), 159.
 Agnes = Eastwell, 159.
 Alicia (Willmer), 158.
 Alicia (Read), 158.
 Alicia (Thackell), 158.
 Alicia = Kendall, 158.
 Alicia (Samson), 158.
 Alicia = Champion, 159.
 Alicia = Miles, 159.
 Alicia = Fremman, 159.
 Ambrose, 84, 159.
 Amicia (Jay), 159.
 Anna = Savage, 158.
 Anna (Parkenhall), 159.
 Anna (Morton), 159.
 Audian, 158.
 Brigetta, 159.
 Edmond, 158.
 Elizabeth (Blakesby), 158.
 Elizabeth (Bingley), 158.
 Elizab. (Salisberie), 185.
 Elizabeth = Smith, 159.
 Elizabeth (Walton), 91, 159.
 Elizabeth = Ward, 159.
 Ellena, 159.
 George, 159.
 Goditha = Lowe, 159.
 Gracia (Thackell), 158.
 Gracia (Otefeild), 158.
 Jocosa, 158.
 John, 79, 91, 158, 159, 185, 205.
 Joseph, 159.
 Lucia, 158.
 Margaret = Perkin, 159.
 Margaret (Goodman), 84.
 Margaret = Goodman, 159.
 Margeria = Grunday, 158.
 Margeria = Fletcher, 159.
 Maria (Meade), 151, 158.
 Maria = Griffith, 205.
 Maria (Bury), 79, 159.
 Maria, 158, 159.
 Nicholas, 158.
 Petronilla = Ward, 158.
 Richard, 158, 159.
 Robert, 158, 159.
 Roger, 159.
 Stephen, 158.
 Thomas, 158, 159.
 Ursula = Hewett, 159.
 Valentine, 158.
 William, 158, 159.

BENT—*continued.*

William (Cater), 158.
 — (Blower), 158.
 — (Goddan), 158.
 — (Gunston), 159.
 — (Parker), 159.
 Berford, Joyce (Everard), 13.
 Petronilla (Charnells), 122.
 Simon, 122.
Beresford, 178.
 BERESFORD, 178.
 John, 178.
 Margareta (Fowler), 178.
 Robert, 178.
 — (Lole), 178.
 Berford or Beresford, 178.
 Adrian, 178.
 Arthur, 178.
 Brian, 178.
 Dorothea = Ashley, 178.
 Dorothea (Danvers), 178.
 Edward, 178.
 Elizabeth (Ashley), 178.
 Elizabeth, 178.
 Francis, 178.
 George, 178.
 Isabella, 178.
 Jocosa, 178.
 Margaria, 178.
 Thomas, 178.
 Beringe — = Dixy, 116.
 Berkeley, *see* Berkley.
Berkley, 2.
 BERKLEY, 2, 3.
 Edward, 3.
 Elianor, 3.
 Elizabeth (—?—), 2.
 Elizabeth = Bursej, 2.
 Elizabeth = Hussey, 2.
 Elizabeth = Levesey, 3.
 Elizabeth = Pagenham, 3.
 Emma (Brokesby), 2.
 Eva (le Zouche), 2.
 Frances = Shirley, 26.
 Henry, Lord, 26.
 Jone (Ferrers), 2.
 John, 3.
 Katherin (Beaumont), 3.
 Margaret (de la Laund), 2.
 Margaret (Harrington), 2.
 Mary (Band), 2.
 Mary (Hall), 3.
 Mauricius, Lord 2.
 Maurice, 2.
 Nicholas, 3.
 Sir Henry, 3.
 Sir John, 2.
 Sir Laurence, 2.
 Sir Maurice, 2.
 Sir Thomas, 2.
 Thomas, Lord 2.
 Ursula, 3.
 William, 2, 14.
 — (Biron), 2.
 Berie and Berrey, *see* Bery.
 Bernard, Hugo, 162.
 Ellena, 162.
 Bertram, Alice = Bouge, 54.
 Berwell, Maria (Staresmore), 5, 99.
 Berwick, Briget = Brokesby, 174.

- Bery*, 207.
 BERY, 207.
 Alicia (Dennis), 207.
 Cave, 207.
 Cornelia = Salisberie, 185.
 Elizabeth (Higate), 207.
 Elizabeth (Hollingworth), 207.
 Francisca, 207.
 George, 207.
 Gilbert, 207.
 Henry, 207.
 James, 207.
 Jana (Smith), 207.
 John, 185.
 Margaret (Cave), 207.
 Margaret (Smith), 66.
 Maria = Bent, 158.
 Maria = Goodwin, 207.
 Maria = Wright, 152.
 Robert, 152, 207.
 William, 207.
 — (Cave), 207.
 — (Dreden), 207.
 — (Pickering), 207.
 — (Sherrard), 207.
 Bevin, Jean, 124.
 Elianor (Montague), 124.
 Beufof, John, 167.
 Agneta = Temple, 167.
Bickerton, 173.
 BICKERTON, 173.
 Alexander, 173.
 Anna (Catlin), 173.
 Anna (Goddard), 173.
 Anna, 173.
 Dorothea = Hancock, 173.
 Edmond, 173.
 Ellin (Turvile), 55.
 Elizabeth, 173.
 Francis, 173.
 Jocosca, 173.
 John, 173.
 Katherin (Waldron), 173.
 Laurence, 173.
 Margaret, 173.
 Martin, 173.
 Nicholas, 173.
 Thomas, 173.
 — (Bradock), 173.
 — (Williams), 173.
 Bidell, Elizab. = Rudiard, 202.
 Bigge —, 146.
 Billesby, Alianora = Gregoric, 188.
 Johanna = Gregorie, 188.
 Richard, 188.
 Billesdon, Walter de, 129.
 Billing — = Whethill, 45.
 Billne, Anne = Pinchbeck, 30.
 Elizab. = Sandford, 30.
 Joan = Pickering, 20.
 Mary (Bellers), 30.
 Sir Thomas, 30.
 Bingham, Richard, 34.
 Anna —, Purifoy, 34.
 Bingley, Elizab. = Bent, 158.
 Elizab. (Nevile), 75.
 John, 75.
 Thomas, 158.
 Bindon, Viscount [Howard], 18.
 — (Segrave), 18.
 Binnington, Thomas, 137.
 Anna (Chamberlaine), 137.
 Biron, Isabella (Skeffington), 8, 112.
 John, 8, 112.
 Lucy (Ashton), 25.
 Sir John, 2.
 Sir Richard, 25.
 — = Berkley, 2.
 Bishop, Thomas, 174.
 Margeria = Leigh, 174.
Bishopston, 21.
 Bispbane, Eliz. (Walleis), 86.
 William, 86.
 Blaby, Hugo de, 93.
 Katherin de (Savill), 93.
 Black, Marg^t (Sherrard), 10.
 Blacket — = Legard, 19.
 Blackwall, Eliz. = Wigley, 97.
 Blackwell, Sense = Draper, 52.
 Blakesby, Eliz. = Bent, 158.
 Thomas, 158.
Blanchminster, 21.
 Blanchminster, Ralphe, 21.
 Cicilia = Nevill, 21.
 Bannerhasset, Anna = Grey, 139.
 John, 139.
 Blasbye, Isabell (Harlop), 9, 196.
 Thomas, 9, 196.
 Bletsho, Marg. = Gore, 85.
 Blewett, Grace (Hartop), 9.
 John, 190.
 Blewett, Katherin = Pochin, 106.
 Maria = Goddard, 190.
 William, 9.
 Blith, Mary (Hasebrigg), 16.
 Blocksome, Agneta (Vough), 194.
 Blount, Crooke al's, 128.
 Anne = Pate, 89.
 Elizab. = Shirley, 25.
 Lucia (Staresmore), 6.
 [Lord Mountjoy], 25.
 Sir Thomas, 25.
 William, 89.
 Blower — = Bent, 158.
 Blunt, George, 55.
 Martha (Turvile), 55.
 Bodington, George, 109.
 Francisca = Allen, 109.
 Bogham, Earl, 169.
 Bollers, William, 162.
 Bolston, Anna = Burton, 57.
 Bolton, Margeria (Staresmere), 6.
 Bonvile, Cicilia = Gray, 74.
 Harrington, Lord, 72, 74.
 William, Lord, 74.
 Boothby — = Corbett, 177.
 Borage, William, 183.
 Alice = Morton, 183.
 Borde, Elizab. = Farnor, 179.
 Borenis, Elianora = Beaumont, 170.
 John, 170.
 Borough, Elina = Barnack, 38.
 John, 206.
 Maria (Babington), 206.
 Borowe, Henry, 155.
 Maria = Mulsho, 155.
 Bostock, Anne (Whethill), 45.
 Bosworth — = Gregorie, 188.
 Botfish — = Allen, 109.
 BOTHOM, 165.
 Alicia (Wolowe), 165.
 Grace (Jackson), 165.
 Hugo, 107, 165.
 John, 165.
 Margareta (Basset), 165, 107.
 Botreux, Lord, 72, 169.
 Cicilia (Beaumont), 169.
 Boughton, Thomas, 126.
 Margeria (Cave), 126.
Bouge, 54.
 Bouge or Bougge, Alice (Bertram), 54.
 Baldwin, 54.
 Edmond, 54.
 Elizabeth (Mulsho), 54.
 Felix (Brokesby), 54.
 Galfridus, 54.
 Margaret = Everingham, 54.
 Margaret = Motton, 54.
 Margaret = Turvile, 54.
 Margaret (Foucher), 54.
 Matilda, 54.
 Ralph, 54.
 Richard, 54.
 Thomas, 54.
 William, 54.
 Bourchier, Anna (Woodvile), 139.
 William, 139.
 Boutort, John, 74.
 Matilda = Gray, 74.
 Bowes, John, 24.
 Bower, John, 156.
 Anna = Wincoll, 156.
 Bowier, Edward, 107.
 Judith = Barret, 107.
 Bowles, Anna = Smith, 67.
 Anna (Winter), 42.
 George, 67.
 John, 42.
 — (Digby), 40.
 Bowman, Isabell = Halford, 144.
 Johanna = Marston, 102.
 Zacharias, 102.
 Bowyer, Eliz. (Draper), 52.
 John, 52.
 Boyer, Anna = Morton, 184.
 Eliz. (Maloric), 184.
 Edward, 184.
 Boys, Mary = Purifoy, 33.
 William, 33.
Brabazon, 47.
 BRABAZON and WOODFORD, 47.
 Jane = Woodford, 47.
 John, 47.
 Roger, 47.
 William, 47.
Brabson, 10.
 Brabson, Elizabeth = Neale, 164.
 John, 164.
 Bracebridge, Edith = Entwissell, 15.
 Richard, 15.

- Bradborne, Eliz. (Turvile), 55.
 Elizab. = Turvile, 55.
 Mary (Turvile), 55.
 Nicholas, 55.
 Sir Humphrey, 55.
 Bradbrig, Elizab. (Winter), 42.
 Thomas, 42.
 Bradford, Alicia = Peek, 147.
 Brian, 147.
 Bradgate, Eliz. (Gerveis), 71.
 Richard, 71.
 Bradley — = Skeffington, 112.
 — = Cockeran, 112.
 Bradock — = Bickerton, 173.
 Braham, Phillippa = Cave,
 120, 127.
 Robert, 120, 127.
 Brandon [E. of Lincoln], 73.
 Charles [D. of Suffolk], 75.
 Katherine (Hastings), 73.
 Francisca (Grey), 75.
 Maria (Tudor), 75.
 Bradsey, Christopher, 18.
Bradshawe, 44, 161.
 BRADSHAWE, 44, 161, 162.
 Anna (Glover), 44, 161.
 Anna (Whethill), 44.
 Anna (Burton), 44, 57, 161.
 Anna, 162.
 Barbara, 162.
 Dorothy (Purifoy), 37, 44.
 Dorothy (Ashby), 13, 161,
 132.
 Dorothea, 44, 162.
 Edward, 162.
 Elizab. = Purifoy, 34, 37, 44.
 Elizab. (Chamberlaine), 162.
 Florence = Reines, 44.
 Francisca (Smalley), 77.
 George, 44, 57, 161, 162.
 Hugh, 17, 44, 161.
 Isabell = Purifoy, 37, 44.
 Jane, 44, 162.
 John, 44, 161, 162.
 Lionell, 77.
 Margaret = Jennings, 44,
 161.
 Margaret (Gibbons), 161.
 Margaret, 44, 161, 162.
 Mary = Corbett, 17, 44,
 48, 161.
 Maria, 162.
 Martha, 162.
 Micheall, 37, 44.
 Richard, 44, 161.
 Robert, 13, 37, 44, 132, 161,
 162.
 Thomas, 37.
 William, 44.
 — (Forster), 44, 161.
 — (Orme), 44, 161.
 — = Printoft, 44.
 — = Cosby, 44.
 — (Colledg), 44.
 — = Haliford, 44.
 — = Watts, 44.
 — (Gibon), 44.
 — (Purifoy), 161.
Brasbridge, 43.
 BRASBRIDGE or BRAS-
 BRIG, 43.
 Alice (Rugeley), 43.
- BRASBRIDGE or BRASBRIG—
continued.
 Anna (Corbyn), 43.
 Anne, 43.
 Anthonie, 43.
 Barbara, 43.
 Dorothy, 43.
 Edward, 43.
 Elizabeth (Winter), 42.
 Elizabeth (Harecourt), 43.
 Elizabeth (Beaumont), 43,
 172.
 Elizabeth, 43.
 Florence, 43.
 Francis, 43.
 Hellen = Hudson, 43.
 Hellen (Creuker), 43.
 Henry, 43.
 Humphrey, 43.
 Hellen, 43.
 Isabell (Whatley), 43.
 Jane (Mill), 43.
 Jane, 43.
 Joan (Lucy), 43.
 Johanna = Temple, 167.
 Joyce (Wilson), 43.
 John, 43.
 Margery = Willington, 43.
 Richard, 43.
 Maria = Eyton, 183.
 Mary (Browne), 43.
 Prudence = Golde, 43.
 Susan (Cotton), 43.
 Symon, 43, 172.
 Thomas, 43.
 William, 43, 183.
 — (Esse), 43.
 — (Nethermill), 43,
 — = Skipwith, 43.
 Brasebridge, Editha = Brokes-
 by, 49.
 Bray, Anna, 112.
 Egidius, 112.
 Katherina (Chetwood), 112.
 Micheall, 112.
 Richard, 112.
 Breerton, Matilda = Noell,
 113.
 Brestofte, Anna = Hubert, 38.
 Thomas, 38.
Breton, 161.
 BRETON, 161.
 Alicia (Wright), 152, 161.
 Christopher, 95.
 Daniell, 161.
 Elizab. (Dacon), 161.
 Elizab. = Ducket, 161.
 Francis, 161.
 John, 161.
 Katherina (Guest), 152, 161.
 Katherina, 161.
 Margaret = Turner, 95.
 Maria = Newton, 161.
 Maria, 161.
 Nicholas, 161.
 Richard, 152, 161.
 Robert, 152, 161.
 William, 161.
Brett, 206.
 BRÉTT, 206.
 Alexander, 206.
 Anna (Beaumont), 171, 206.
- BRETT—*continued.*
 Anna = Cranfeild, 206.
 Arthur, 206.
 George, 206.
 Henry, 206.
 Joan (Palmer), 39.
 Katherin = Ashby, 14.
 Margareta (Seames), 206.
 Robert, 14.
 William, 39, 171, 206.
 Brian, Guy de, 23.
 John, 195.
 Maria = Dixon, 195.
 Matilda de = Camville, 23.
 Bridemaine, Thos., 9, 196.
 Mary = Hartop, 9, 196.
 Bridges, Eliz. = Turvile, 55.
 Jana (Savill), 93.
 Richard, 93.
 Thomas, 55.
 Britaine, Goditha = Trunnell,
 176.
 Walter, 176.
 Broadgate — = Wright, 152.
 Brocas, Barnard, 141.
 Frances = Hasebrigge, 16.
 Francisca = Bale, 141.
 William, 16.
 Brocket, Anne (Cave), 127.
 Edward, 130.
 John, 15, 127.
 Johanna (Thame), 130.
 Mabilia = Haselrigge, 15.
 Margaret (Hastings), 15.
 Brodgate, Grace = Halford,
 144.
 Katherin (Strelley), 194.
 Maurice, 194.
 Brokas, Francis = Starismore,
 99.
 William, 99.
Brokesby, 49.
 BROKESBY.
 Agnes (Ashby), 14.
 Alice (Sherley), 49.
 Alicia = Pochin, 106.
 Anna = Walcott, 49.
 Anne (Sapcotts), 49.
 Anthony, 49.
 Bartholomew, 49, 173.
 Bersheba = Leigh, 174.
 Brigetta (Berwick), 174.
 Dorothy (Congreve), 49.
 Dorothea (Wiseman), 49.
 Editha (Brasebridge), 49.
 Edward, 49, 106.
 Elizab. (Stanton), 173.
 Ellin (Vaux), 49.
 Emma = Barkley, 49.
 Emma (Miles), 49.
 Felix = Bouge, 54.
 Francis, 49, 174.
 Henry, 49, 54.
 Humphrey, 49.
 Jana (Beaumont), 60, 172.
 John, 49.
 Lucy = Woodford, 38.
 Maria = Vincent, 81, 82.
 Maria, 49.
 Richard, 49, 173.
 Robert, 49, 60, 172, 173, 174.
 Thomas, 173.

BROKESBY—*continued.*

- William, 49, 173.
 Winifred = Inglefeild, 49.
 Bromfeild, Anthony, 108.
 Elizab. (Cooke), 108.
 Bromley, Marg^t (Whaley), 148.
 Robert, 148.
 William de, 133.
 Bronwick, Eliz. (—?—), 51.
 Henry, 51.
 Isabell, 51.
Brooke, 65.
 BROOKE, 65.
 Agnes (Winter), 24.
 Alice = Leeche, 65.
 Alice = Delves, 65.
 Alice (Croxtan), 65.
 Anne (Venables), 65.
 Anne (Whitney), 65.
 Anne = Sheldon, 65.
 Anne (Audeley), 65.
 Andrewe, 65.
 Arthur, 136, 146, 186.
 Christian (Carew), 65.
 Dorothy (Smith), 146.
 Edward, 65.
 Elizabeth (Starkie), 65.
 Elizabeth = Walker, 65.
 Henry, 65.
 Jane (Meverell), 65.
 Jana (Salisberie), 186.
 John, 65.
 Margaret = Maneringe, 65.
 Margerie (Manwaring), 65.
 Margery (Staveley), 136.
 Ralphe, 65.
 Reingnold, 65.
 Richard, 65.
 Robert, 65.
 Sir Bassett, 65.
 Sir Richard, 65.
 Thomas, 65, 146.
 William, 25.
 — (Fetherston), 65.
 Brooke, Lord, 16.
Brookesby, 201.
 BROOKESBY, 201.
 Alicia (Shirley), 201.
 Alicia (Michell), 201.
 Anthony, 201.
 Bartholomew, 201.
 Elizabeth (Goodwin), 201.
 Elizabetha, 201.
 Francisca, 201.
 George, 201.
 Humphrey, 201.
 Johanna (Frank), 201.
 John, 201.
 Margaret (Wake), 201.
 Margareta = Wase, 200.
 Mary = Ebney, 114, 201.
 Maria, 201.
 Phillip, 201.
 Richard, 201.
 Robert, 201.
 Thomas, 196, 200, 201.
 William, 38, 201.
 Brough — (—?—), 195.
 Browne, Anna (Sherman), 204.
 Beatrix (Shirley), 25.
 Elizab. = Purifoy, 32, 33.
 Elizab. (Sherman), 204.

Browne—*continued.*

- Isabella = Purifoy, 35.
 John, 25, 35, 36.
 Katherin (Skeffington), 112.
 William, 112.
 Browne, Sir John, 43.
 Mary = Brasbridge, 43.
 Browne, Alice (Digby), 41.
 Anthony [V. Montague], 75.
 Anne = Dannel, 64.
 Elizabeth (Skeffington), 112.
 Frances = Ashby, 64.
 Sir Mathew, 64.
Brow, 10.
 Broxley, Marg^t (Hartop), 9.
 Thomas, 9.
 Broysesfeild, Katherine = Purifoy, 35.
 Richard, 35.
Brudnell, 143.
 BRUDENELL, 143.
 Agnes = Flacket, 143.
 Anna = Ap Rese, 143.
 Anna, 143.
 Anthony, 143.
 Dorothea (Smith), 143.
 Edmund, 143.
 Elizabeth (Burnell), 143.
 Elizabeth, 143.
 Ellena = Felder, 143.
 Francisca, 143.
 George, 143.
 Jana (Elrington), 143.
 Jana, 143.
 Margaret (Entwisell), 143.
 Margareta = Palmer, 143.
 Paul, 143.
 Richard, 143.
 Robert, 143.
 Thomas, 143.
 William, 143.
 — (Everard), 13.
 — (Freeman), 143.
 — (Warner), 143.
 — (Wymark), 143.
 Bruin, Henry, 24.
 Johanna = Burdet, 24.
 Buckby, William, 137.
 Maria = Walker, 137.
 Buckingham, C^{ess} of [Beaumont], 171.
 C^{ess} of [Villers], 30.
 M^q of [Villers], 30.
 Ed. D. of [Stafford], 195.
 Buckland, William, 135.
 Margery = Nowers, 135.
Bugg, 12, 50.
 Baldwin, 59.
 Bugg, Galfridus, 103.
 Isabella = Peper, 103.
 Mary (Motton), 59.
 Bugges, Anna = Mutton, 80.
 Thomas, 80.
 Bullock, Alicia (Cooke), 108.
 Thomas, 108.
Bulmer, 21.
 Bunning, Richard, 92.
 Francisca = Whiting, 92.
 — = Whiting, 92.
 Bunting — = Wigley, 97.
Burdet, 23.
 BURDET, 23, 24.

BURDET—*continued.*

- Agnes = Shepey, 24.
 Agnes (Waldif), 24.
 Amabilia (—?—), 140.
 Anne = Bowes, 24.
 Anne, 24.
 Blanch = Samborn, 24.
 Briget (Curson), 24.
 Briget (Greisley), 24.
 Briget, 24.
 Dorothy, 24.
 Elinora (Veale), 23.
 Elianor = Willerscotts, 24.
 Elizabeth (Camvil), 13, 23.
 Elizab. (Garshull), 23.
 Elizabeth (Allen), 109.
 Elizabeth = Stafford, 24.
 Elizabeth (Cokaine), 24.
 Elizabeth = Hutton, 24.
 Elizabeth, 24.
 Felicia, 23.
 Francis, 24.
 Geraldus, 23.
 Gerard, 18.
 George, 24.
 Hawise = Harecourt, 18.
 Hugo, 23, 140.
 Hugh, 18.
 Humphrie, 24.
 James, 18.
 Jane (Francis), 24.
 Jane, 24.
 Johanna (Bruin), 24.
 Johanna (Harvy), 140.
 John, 18, 23, 24, 140.
 Juliana (—?—), 140.
 Katherine = Tedley, 24.
 Katherine (Gerveis), 71.
 Margaret (Rodney), 24.
 Mary (Throckmorton), 24.
 Mary (Wilson), 24.
 Mary (Frampton), 24.
 Maria (Croft), 140.
 Maria (Cave), 125.
 Michaeil, 18.
 Nicholas, 18, 23, 24, 140.
 Osborn, 24.
 Richard, 18, 23, 71, 109, 140.
 Robert, 18, 23, 24, 140.
 Sir Richard, 18.
 Sir Robert, 18.
 Thomas, 24, 140.
 William, 18, 23, 24.
 — = Camois, 24.
 — (Harewell), 24.
 Burgaine, Eliz. = Temple, 167.
 Robert, 167.
 Burgalaine, Robert, 185.
 Eliz. = Salisberie, 185.
 Burgh, Richard, 8.
 Burnaby, Anna = Robertes, 203.
 Thomas, 203.
 Burnell, Eliz. = Brudnell, 143.
 Eliz. = Cave, 128.
Burton, 56, 121, 160.
 BURTON, 56, 57, 160.
 Abigall (Whiting), 92.
 Adam de, 56.
 Abigall (Chomley), 160.
 Alicia (Peck), 160.
 Anne (Bolston), 57.

BURTON—*continued*.

Anne = Bradshawe, 57, 161.
 Anna (Digby), 160.
 Anna (Reinolds), 160.
 Anna, 161.
 Barton, 160.
 Dorothy = Willnes, 57.
 Dorothy (Faunt), 28, 57.
 Edward, 57.
 Elizabeth (Cotton), 57.
 Elizabeth (Ockover), 57.
 Elizabeth (Hardwick), 57,
 140.
 Elizabeth, 57, 160.
 Frances, 57.
 Francis, 160.
 George, 57.
 James, 57.
 Jane, 57.
 Joan (Creucure), 56.
 John, 160.
 Jone, 160.
 John de, 56.
 Katherin = Milles, 57.
 Katherin (Ripington), 42, 57.
 Katherine, 57.
 Mary = Wakefeilde, 57.
 Matilda (Gibon), 57.
 Mawde (Curtois), 57.
 Mudwynne = Creueker, 43,
 57.
 Nicholas de, 56.
 Oliver, 56, 57.
 Phillippa (Cobham), 160.
 Raphe, 43, 44, 57, 140.
 Richard, 57, 120.
 Robert, 42, 57, 140.
 Rous, 92.
 Rudolph, 28.
 Sir James, 56, 120.
 Sir Thomas, 160.
 Susanna (Wilcockes), 136.
 Thomas, 57.
 William, 57, 136, 140, 160.
 — Sharpe, 89.
 Bury, Briget (Cave), 127.
 Dionisia = Halford, 144.
 Gilbert, 127.
 James, 127.
 John, 79.
 Mary (Cave), 127.
 Maria = Bent, 79.
 Maria = Vincent, 79.
 Bushby, Francisca (Whaley),
 148.
 Jone (Dixon), 195.
 Richard, 148.
 Robert, 195.
 Bussie, Gracia (Halford), 144.
 Milo, 144.
 Bussy, Edward, 145.
 Elizabeth (Berkley), 2.
 Elizabeth = Halford, 145.
 Sir John, 2.
Butler, 64.
 Butler, Elizabeth = Everard,
 13.
 — = Everard, 50, 80.
 — = Purifoy, 39.
 Elizabeth (Villers), 30.
 Sir John, 30.
 Byrond, John, 20.

Byrond—*continued*.

Isabell = Lyard, 20.
 Cage = (Wincoll), 156.
Caldwell, 192.
 CALDWELL, 192.
 Alicia (More), 192.
 Anna (Helmsted), 192.
 Anna (Purshull), 192.
 Anna, 192.
 Dorothy (Morton), 192.
 Edward, 192.
 George, 192.
 Jane = Acton, 192.
 Johanna (Fishwick), 192.
 Johanne, 192.
 John, 192.
 Joseph, 192.
 Maria (Skinner), 192.
 Maria = Weston, 192.
 Presilla = Nicolls, 192.
 Rebecca, 192.
 Richard, 192.
 Robert, 192.
 Samuel, 192.
 Sara = Dannet.
 Talbot, 192.
 Thomas, 192.
 William, 192.
 — (Smith), 192.
 Calthrop, Eliz. (Smith), 66.
 Martin, 66.
 Calverley, Maude (Hubert), 38.
 Sir Hugh, 38.
 Camden, Viscount, 4.
Cambrudy, 7.
 Cambridge, Jone (Donne), 7.
 Matilda = Oldbeefe, 110.
 Maude = Oldbeefe, 7.
 William, 7, 110.
 Cambridge, E. of [Hamilton],
 31.
 Camois, 24.
 Camvile, Albreda (Marmion), 23.
 Elizab. = Burdet, 18, 23.
 Galfrid, 23.
 Isend (—?)—, 23.
 Matilda (de Brian), 23.
 Matilda = Stafford, 23.
 Sir Geoffrey, 18.
 William, 23.
 Cannon, Joanna = Dixson, 195.
 Capet, John, 83.
 Johanna (Warde), 83.
 Cardwell, Eliz. = Gore, 85.
 Carew, Christian = Brooke, 65.
 Gawen, 6.
 Goditha = Staresmore, 6.
 John, 65.
 Maria = Whiting, 92.
 Carey, Anna (Corbet), 177.
 Carick, Emma (Wigley), 97.
 Francis, 97.
 Carlton — = Digbie, 199.
 Carre, Emmot = Hollingworth,
 184.
 William, 184.
Carrington, 130, 131, 145.
 CARRINGTON al's SMITH,
 131, 145, 146.
 Anna (Farnell), 131, 145.
 Edmond, 145.

CARRINGTON al's SMITH—*cont.*

John, 131, 145.
 Katherin (Montague), 131, 145.
 Katherin (Heriell), 145.
 Margaret (Rosse), 131, 145.
 Michael, 145.
 Millicent (Laynham), 131,
 145.
 Sir Michael, 145.
 Sir William, 131, 145.
 Cartier — = Duport, 124.
 Cartwright, Joane (Legard), 19.
 Thomas, 19.
 Castlehaven, Earl of, 4.
Cater, 1.
 CATER, 1.
 Alice (—?)—, 1.
 Cornelius, 1.
 Edward, 1.
 Francis (Baynes), 1.
 George, 1.
 Gertrude (Harvy), 1.
 Henry, 1.
 John, 1.
 Mary (Dent), 1.
 Richard, 1.
 Suzan, 1.
 William, 1.
 Catesby, Anne (Haselrigge),
 15.
 Edward, 15.
 Margaret (Purifoy), 33.
 Modwina (Smalley), 75.
 Catiell, Richard, 98.
 Margareta (Whitalph), 98.
 Catlin, Judge, 173.
 Anna = Bickerton, 173.
Cave, 122.
 CAVE, 120, 122, 125, 126, 127,
 128, 133.
 Abigail = Sherrard, 10.
 Agnes (Houghton), 127.
 Alexander, 125, 127.
 Alicia = Skeffington, 111.
 Ambrose, 126, 128.
 Anna = King, 120, 127.
 Anna = Sherman, 128, 204.
 Anna (Warde), 125.
 Anna = Stapleton, 125.
 Anna = Ingoldby, 125.
 Anna (Marshall), 68, 126.
 Anna = Marshall, 126.
 Anna = Hampden, 126.
 Anna (Lany), 127.
 Anna (Brocket), 127.
 Anna (Durant), 127.
 Anna (Hunston), 127.
 Anna = Smith, 127.
 Anna, 128, 133.
 Anthony, 120, 124, 126, 127,
 128, 207.
 Augustin, 128.
 Barbara, 133.
 Barbara (Feilding), 128.
 Brian, 120, 127, 128, 133.
 Brigetta = Bury, 127.
 Brisetta = Tanfeild, 128.
 Barbara (Devereux), 73, 128.
 Catherina (Somerville), 125.
 Catherina = More, 125.
 Cicell, 10.
 Clement, 126.

CAVE—*continued.*

Beatrix, 125.
 Constance (Leedes), 125.
 Dorothy, 120.
 Dorothy (Smith), 66, 128.
 Dorothea (Malory), 126.
 Dorothea = Barnard, 127.
 Dorothea = Evans, 127.
 Dorothea = Gray, 128.
 Edward, 120, 126, 127, 128.
 Elianora (Gray), 128.
 Elizabeth, 122, 127, 128, 133.
 Elizabeth (Constable), 125.
 Elizabeth (Marvin), 126.
 Elizab. (Danvers), 40, 111, 126.
 Elizabeth (Lovet), 126.
 Elizabeth = Wirley, 126.
 Elizabeth (Burnell), 128.
 Elizabeth (Isham), 128, 133.
 Elizabeth (Ewart), 128.
 Elizabeth (Marbery), 133.
 Erasmus, 133.
 Eusebius, 133.
 Francis, 40, 80, 120, 122, 126, 128, 133, 206.
 Francisca = Shuger, 122.
 Francisca (Duport), 124, 127.
 Francisca = Jenkenson, 127.
 Francisca (Dreden), 133.
 Francisca, 128.
 George, 133.
 Grace, 125.
 Henry, 68, 120, 126, 127, 128, 133.
 Isabella (Allen), 120, 127.
 Isabella (Needham), 100.
 Isabella (Wake), 127.
 Isabella = Chippingdale, 127, 157.
 Jane (Vincent), 50, 80.
 John, 122, 125, 127, 128, 133.
 Juditha, 122.
 Juditha (Porter), 122.
 Juditha = Chester, 126.
 Katherina, 120.
 Katherina = Andrewes, 126.
 Katherina (Colt), 127.
 Katherina = Cheyney, 127.
 Lisle, 120, 122, 127.
 Marcia, 128.
 Margareta, 120.
 Margareta (Lisle), 120, 122, 126.
 Margaret (Cecill), 66.
 Margareta (Saxby), 126.
 Margareta (Wellington), 126.
 Margareta (Knolles), 126.
 Margareta (Babington), 127.
 Margaret (Skeffington), 8.
 Margareta (Clermont), 127.
 Margareta = Babington, 127, 206.
 Margareta = Bury, 207.
 Margareta (Throckmorton), 128.
 Margareta (Trussell), 128.
 Margareta (Marbery), 133.
 Margeria (Cowper), 151.
 Margeria = Boughton, 126.
 Margeria (Farnham), 77.

CAVE—*continued.*

Maria, 122, 128, 133.
 Maria = Peck, 128, 147.
 Maria (Samson), 122.
 Maria (Genill), 125.
 Maria = See, 125.
 Maria = Weston, 126.
 Maria = Lounde, 125.
 Maria (Burdet), 125.
 Maria (White), 128.
 Mary, 133.
 Mary = Skeffington, 112.
 Martha, 122.
 Martha = Newdigate, 126.
 Matilda (Maldacum), 125.
 Mathew, 128.
 Maude = Perwich, 63.
 Phillippa (Braham), 120, 127.
 Pierce, 125.
 Piers, 125.
 Prudentia (Crooke), 128.
 Ralph, 126.
 Richard, 66, 122, 126, 128, 133.
 Robert, 125.
 Roger, 66.
 Rosa = Harecourt, 128.
 Rosa = Hunnings, 128.
 Ruth, 122.
 Sir Alexander, 125.
 Sir Thomas, 8.
 Susanna (Fineux), 151.
 Susanna, 122.
 Temperans, 127.
 Theophilus, 120, 127.
 Thomas, 9, 40, 77, 100, 111, 125, 126, 128, 151, 152, 157, 192, 207.
 Tobias, 127.
 Ursula = Davenport, 122.
 William, 17, 120, 127, 128, 147, 206.
 — (Belgrave), 68, 126.
 — (Malorie), 126.
 — (Passemer), 126.
 — (Cliffe), 127.
 Cawley, Alice = Gregorie, 188.
 Robert, 188.
Chamberlaine, 137.
 CHAMBERLAINE, 137.
 Anna (Stanford), 137.
 Anna = Binnington, 137.
 Elizab. = Bradshawe, 162.
 Elizabeth, 137.
 Francis, 137.
 Francisca (Jervis), 137.
 Henry, 137.
 Jocosa = Turner, 95.
 John, 137.
 Libeus, 95.
 Margareta (Poole), 137.
 Ralph, 9, 197.
 Richard, 162.
 — = Hartop, 197.
 — = Ward, 83.
Chambers, 51.
 CHAMBERS, 51, 52.
 Barbara (Pochin), 52, 106.
 Ellinor (Dannet), 51.
 Elizabeth, 52.
 Elizabeth (Villers), 51.
 John, 52.

CHAMBERS—*continued.*

Mary = Barnes, 52.
 Richard, 51, 52, 106.
 William, 51, 52.
 — (Ashbie), 52.
 — (Lathberye), 51.
 — (Mallowe), 51.
Champaine, 12, 50, 53.
 Champaine, Hugo de, 53.
 Nicholas de, 53.
 Champion, Alicia (Bent), 159.
 Elizab. = Hardwick, 53.
 John, 103, 159.
 Katherin = Marshall, 103.
 Marg^t = Foucher, 53.
 Marg^t (St Loo), 53.
 Robert, 53.
 Sir Robert, 53.
 Chancellor, Thos, 26.
 Alice (Shirley), 26.
 Chancy al's Giles, 118.
 Chantrell, Robert, 67, 68.
 Maria = Belgrave, 67.
 Mary = Belgrave, 68.
 Chaplin — = Wincoll, 156.
 Chapman, Edward, 194.
 Elizab. (Strelley), 194.
 — = Gore, 85.
 Charde, Edward, 181.
 Elizab. = Baynbrig, 181.
 Chare, Elizab. = Bainbrig, 190.
 Charles, Nicholas [Lanc. Her.], 123.
Charnells, 122.
 CHARNELLS, 122, 123.
 Anna, 123.
 Cicilia (—?—), 122.
 Edward, 123.
 Elizab. (Francis), 123.
 Francisca = Allen, 123.
 Godierus, 123.
 John, 123.
 Katherina = Wirley, 123.
 Muriella, 123.
 Muriella (Arden), 123.
 Nicholas, 122.
 Petronilla (Bereford), 122.
 Ralph, 122.
 Robert, 123.
 Thomas, 123.
 Walter, 123.
 William, 122, 123.
 — = Hayward, 123.
 Chaweband, Eliz. = Swyke, 68.
 Chaworth, Elizab. (Noell), 4.
 John, 4.
 Maria = Crofte, 140.
 George, 140.
 [Viscount], 4.
 Chedlow, Juditha = Morton, 184.
 Cheney, Christian, 129.
 Katherin (Cave), 129.
 Cheny, Catherin = Kempe, 27.
 Cheselden, Alice (Wilston), 20.
 Anna (Skevington), 20.
 Briget (Montgomerie), 20.
 Edward, 20.
 Elizabeth, 20.
 Ema (—?—), 20.

Cheselden—*continued.*

Richard, 20.
 Thomas, 20.
 William, 20.
 CHESELDON, 107.
 Anna, 107.
 Anna (Stacy), 107.
 Anna (Warde), 83.
 Elizabeth, 107.
 Francisca, 107.
 George, 107.
 James, 20.
 Johanna (—?—), 107.
 Jocosa, 107.
 Jocosa (Barsby), 107.
 John, 20, 107.
 Kellam, 20.
 Richard, 107.
 Thomas, 107.
 William, 107.
 — (Marbury), 20.
 Cheselhurst, Thomas, 36.
 Beatrix = Purifoy, 36.
 „ = Strelley, 36.
Cheselton, 20.
 CHESELTON, 20.
Chester, 138.
 CHESTER, 138.
 Alicia = Sharpe, 138.
 Anna = Sharpe, 138.
 Augusten, 138.
 Brigetta (Sharpe), 138.
 Charles, 138.
 Clement, 138.
 Dorothea (Hooker), 138.
 Febe (Michell), 138.
 Frances (Tuffe), 138.
 George, 138.
 Jana (Savill), 138.
 John, 136.
 Juditha (Cave), 126.
 Leonard, 136.
 Maria, 136.
 Maria = Roberts, 117.
 Robert, 136, 203.
 Samson, 136.
 William, 117, 126, 136.
 — = Robertes, 203.
 Chettle, Anna = Morton, 184.
 Chetwin, Walter, 73.
 Chetwood, Anne (Laurence),
 102.
 Isabella (Noell), 113.
 John, 102.
 Katherin = Skevington, 8,
 112.
 „ = Bray, 112.
 Richard, 8, 112.
 Thomas, 113.
 Chibenhurst, Thomas, 33.
 Beatrix = Purifoy, 33.
 Chicheley, Clement, 3.
 — = Pagenham, 3.
 Chichester, Francis (Harring-
 ton), 59.
 Sir Robert, 59.
Childe, 7.
Chippingdale, 157.
 CHIPPINGDALE, 157.
 Christina = Staresmore, 99,
 157.
 Edmund, 157.

CHIPPINGDALE—*continued.*

Edward, 157.
 Elizabeth, 157.
 Elizabeth = Bale, 142, 157.
 Elizabeth (Harkes), 157.
 Elizabeth = Meredith, 157.
 Francisca (Oliver), 157.
 George, 157.
 Henry, 157.
 Isabella (Cave), 157.
 Johanna (—?—), 157.
 John, 99, 142, 157.
 Katherin = Walker, 157.
 Katherin, 157.
 Maria, 157.
 Maria (Garret), 157.
 Stevens vel, 6.
 Tobias, 127, 142, 157.
 William, 157.
 Chomley, Abigall = Burton,
 160.
 Ciampanti, Kath. (Robertes),
 203.
 Cicell, Albania, 4.
 Dorothea, 4.
 Margaret = Cave, 66.
 „ = Smith, 66.
 [Lord Burley].
 Sir Edward, 4.
 Clare, Isabell = Rockley, 74.
 William, 74.
 Clarence, D. of [Plantagenet],
 72.
 Claremont, — = Duport, 124.
 Clarke, Agneta = Bent, 159.
 Collet = Beaumont, 60.
 Edmond, 194.
 Francisca (Strelley), 194.
 Jana = Gregorie, 189.
 Richard, 60.
 William, 159.
 Clarvaux, Alice (Faunt), 28.
 John, 28.
 Thomas, 28.
 — = Faunt, 28.
 Clavering, John, 21.
 Euphemia = Nevill, 21.
 Claxston, Ralph, 103.
 Sibilla = Marshall, 103.
 Cleark, Mary = Corbet, 48.
 Thomas, 48.
Clerk, 40.
 Clerk, Agnes = Digby, 40.
 „ = Seddell, 40.
 Colletta = Beaumont, 170.
 John, 40.
 Richard, 170.
 Clerke, Anna (Vincent), 79.
 Mary = Corbet, 17.
 Richard, 79.
 Thomas, 17.
 Clerkson, Elizab. (Hartop),
 197.
 Michaell, 197.
 Clermont, George, 127.
 Margaret = Cave, 127.
 Cleyton, Margeria (Turville),
 55.
 Cliffe, Ellin = Legard, 19.
 Nicholas, 19.
 — = Cave, 127.
 Clifton, Alice (Digby), 40.

Clifton—*continued.*

Alice (Nevill), 21.
 Cuthbert, 131.
 Dorothea (Smith), 131.
 Gervice, 21.
 Climpeston, John, 119.
 Marg^t = Sturton, 119.
 Clinton, Mary = Prestwich,
 63.
 Cliveroe, — = Cotton, 191.
 Cobham al's Brooks, Henry,
 160.
 Philippa = Burton, 160.
 Coble, William, 63.
 Alicia (Houghton), 63.
 Mary = Pace, 63.
 Cockaine, Elizab. = Everard,
 142.
 Sir John, 25.
 Thomas, 142.
 Cockeran, — (Bradley), 112.
 Cockin, Anne (Repington), 42.
 Thomas, 42.
 Cogan, Dorothy (Pochin), 106.
 William, 106.
 Cokaine, Elizab. = Burdet,
 24.
 Sir Thomas, 24.
 Coke, William, 86, 148.
 Isabella = Danvers, 86.
 Margaret = Whalley, 148.
 Colborne, John, 97.
 Katherina = Wigley, 97.
 Colbron, Humphrie, 20.
 Coleclough, Anne = Wase,
 200.
 Thomas, 200.
 Coleman, Johanna = Halford,
 144.
 Coles, Amicia (Ward), 83.
 Amy = Vincent, 80.
 Alexander, 83.
 Peter, 80.
 — = Vincent, 50.
 Colledg, — = Bradshaw, 44.
 Colley, Anthony, 8, 111.
 John, 154.
 Katherin (Skeffington), 8,
 111.
 Maria (Abney), 154.
 Collingwood, Robert, 15.
 Elizabeth (Haselrigg), 15.
 Collins, Ellina (Marston), 101.
 James, 204.
 Maria = Hall, 204.
 William, 101.
 Colman, Henry, 101.
 Margaret (Marston), 101.
Colsell, 7.
 Colt, Katherin = Cave, 127.
 Thomas, 127.
 Colteclough, Dorothy = Stur-
 ton, 119.
Colvile, 12, 60.
Comberford, 5.
 Compton, Francisca (Hastings),
 73.
 Henry, Lord, 73.
 Mary (Beaumont), 60, 171.
 Sir Thomas, 60.
 Thomas, 30, 171.
 [E. of Northampton], 171.

- Congrave, Dorothea Brokesby, 49.
 Dorothea (Gifford), 26.
 John, 26, 49.
- Coniers, Dorothy = Noell, 3, 114.
 „ = Flower, 3, 114.
 Richard, 3, 114.
- Coningham, Maria = Mulsho, 155.
 John, 155.
- Constable, Elizab. = Cave, 125.
 Jones (Nevill), 22.
 John, 125.
 Margaret = Legard, 19.
 Sir John, 22.
 Thomas, 19.
- Cooe, Joane = Smith, 66.
 John, 66.
- Cook, Oliver, 9, 196.
 Precilla (Hartop), 9, 196.
- COOKE, 108.
 Abraham, 108.
 Agneta = Lichfeild, 108.
 Alicia = Bullock, 108.
 Anne = Turville, 55.
 Anthony, 75.
 Eliz. = Bromfeild, 108.
 Eliz. (Twigden), 108.
 Eliz. = Gilbert, 189.
 Francisca = Gray, 75.
 Isack, 108.
 James, 108.
 John, 108.
 Katherin (Robertes), 117.
 Katherina = Watkin, 108.
 Margareta (Greene), 108.
 Margareta = Shepard, 108.
 Sir Edward, 46.
 Susanna, 108.
 William, 75, 108, 189.
 Winifred = Mungay, 46.
 „ = Neele, 46.
- Cooney, Alicia = Farrent, 202.
- COOPER, 90.
 Alicia, 90.
 Christian, 90.
 Daniell, 90.
 Edmund, 90.
 Elizabeth (Gilbert), 90.
 Elizabeth (Frier), 90.
 Emmot, 90.
 Francis, 90.
 Galfred, 90.
 George, 90.
 Gilbert, 90.
 Grace, 90.
 Jana (Staresmore), 90.
 Joanna (Dawson), 90.
 John, 90.
 Jones, 90.
 Katherin, 90.
 Lidia, 90.
 Margeria (Denston), 90.
 Maria = Farrent, 202.
 Maria = Alsop, 105.
 Maria, 90.
 Mathew, 90.
 Richard, 202.
 Samuel, 90.
 William, 90, 105.
- Copendall, — = Logard, 19.
Corbet, 17, 48, 177.
- CORBET, 17, 48, 177.
 Agnes (Fay), 48.
 Andreas, 177.
 Anna (Windsor), 177.
 Anna = Carey, 177.
 Anna, 177.
 Anne = Belgrave, 68.
 Anne (Wimark), 17, 48.
 Anne (Ive), 17.
 Arthur, 17, 44, 48, 101.
 Christopher, 17, 48.
 Dorothea (Poyner), 177.
 Edward, 17, 48.
 Elizabeth = Curson, 177.
 Elizabeth = Wallop, 177.
 Hierome, 177.
 Humphrey, 17, 48.
 Jana (Banister), 165, 177.
 Jana, 177.
 John, 17, 48.
 Margaret = Palmer, 177.
 Mary (Bradshawe), 17, 44, 48, 161.
 Mary (Clerke), 17, 48.
 Richard, 177.
 Robert, 165, 177.
 Roger, 17, 48, 177.
 Rowland, 17, 48.
 Sir Robert, 177.
 Sir Thomas, 38.
 Thomas, 48, 177.
 Vincent, 177.
 Walter, 177.
 — (Boothby), 177.
 — (Hubert), 38.
 — (Humberston), 177.
 — (St. John), 177.
- Corbison, Rachell (Bainbrig), 190.
 Thomas, 190.
- Corbyn, Anne = Brasbridge, 43.
 Thomas, 43.
- Cosby, — (Bradshawe), 44.
- Cotes, 94.
- COTES, 94.
 Agneta (Sterkie), 94.
 Alexander, 91, 94.
 Anna = Swinfon, 94.
 Anna (Warde), 94.
 Anna (—?), 94.
 Ellena (Yarde), 94.
 Elinora (Yarde), 91, 94.
 Elizabeth = Andrewes, 94.
 „ = Linfeild, 94.
 Francis, 94.
 Hellena (Gillett), 94.
 John, 91, 94.
 Katherina = Foxley, 94.
 „ = Roe, 94.
 Robert, 94.
 Roger, 94.
 Thomas, 94.
- Cotton*, 191.
- COTTON, 191, 192.
 Ann, 192.
 Anna (Smith), 191.
 Anna (Tarlton), 191.
 Anna = Leadoch, 191.
 Dorothea, 192.
- COTTON—*continued*.
 Edmond, 191.
 Edward, 191, 192.
 Elizabeth, 192.
 Elizabeth = Horton, 191.
 Elizab. = Shukebrough, 192.
 Elizabeth = Sherrard, 88.
 Elizabeth = Burton, 51.
 Eusiby, 192.
 Goditha = Parker, 191.
 Hanna = Cradock, 149.
 Henry, 192.
 Jana = Sutton, 192.
 John, 68, 88, 96, 192.
 Jonathan, 191.
 Lucia (Harvy), 140.
 Margareta (Villers), 191.
 Margareta = Belgrave, 68, 96.
 Martha = Saunders, 191.
 Mary, 192.
 Nathaniell, 191.
 Richard, 42.
 Robert, 191, 192.
 Ruth, 192.
 Samuell, 192.
 Sara, 192.
 Susan = Basbridge, 43.
 Thomas, 43, 57, 140, 149, 191, 192.
 William, 191, 192.
 — (Cliveroe), 191.
- Couper, Alicia = Ball, 141.
 Amy (Whithill), 45.
- Courteney [E. of Devon], 74.
 Elizab. (Grey), 74.
- Cowley*, 119.
- Cowper*, 152.
- COWPER, 152.
 Agnes, 152.
 Agnes = Glover, 152.
 Agneta (Luffe), 152.
 Anthony, 152.
 Elizabeth (Gramer), 152.
 Elizabeth (Phillipps), 152.
 Francis, 152.
 George, 152.
 Henry, 152.
 Katherin = Pollard, 152.
 Margeria (Cave), 152.
 Robert, 152.
 Susanna = Becke, 152.
 Susanna (Lovet), 152.
 Susanna, 152.
 Thomas, 152.
 William, 152.
- Cox, Anna = Banister, 165.
 Anna (Swynfen), 13.
 Elizab. = Swynfen, 134.
 Martha = Staresmore, 6, 99.
 Richard [Bp. of Eli], 124.
 Thomas, 165.
 William, 134.
- CRADOCK, 149.
 Benjamin, 149.
 Edward, 149.
 Elizabeth, 149.
 Elizabeth (Longe), 149.
 Hanna, 149.
 Hanna (Cotton), 149.
 John, 149.
 Joseph, 149.

CRADOCK—*continued.*

Maurice, 149.
 Robert, 149.
 Sara, 149.
 Thomas, 149.
 William, 149.
 Cranfeild, Anna (Brett), 206.
 Lionell, 206.
 Cranwell, John, 102.
 Elizab. (Laurence), 102.
 Crathorn, John, 116.
 Jana = Dixey, 116.
 Creach, Anna (Digby), 199.
 Sammuell, 199.
 Creekland, Alicia = Davies, 117.
 „ = Robertes, 117.
 Cresses, Robert, 99.
 — = Staresmore, 99.
 Creswell, John, 185.
 Anna = Salisberie, 185.
 Creueker, William, 57.
 Mudwynne (Burton), 57.
Creuker, 56.
 Creuker, Joan = Burton, 56.
 Crewker, Anne = Teverey, 43.
 Anthony, 43.
 Elizabeth (Winter), 43.
 Hellen = Brasbridg, 43.
 John, 43.
 Mudwynam (Burton), 43.
 William, 43.
 Crispe, Elizab. (Lawrence), 102.
Croft, 140.
 CROFT, 140, 141.
 Anna (Ducket), 140.
 Anna = Meade, 141.
 Anna (Tilson), 140.
 Anthony, 140.
 Barnabas, 140.
 Dorothea (Harvey), 140.
 Dorothea, 140.
 Dorothea = Wightman, 141.
 Elizabeth = Barwell, 140.
 Elizabeth = Goodall, 140, 141.
 Esaias, 140.
 George, 141.
 Gracia = A verey, 141.
 Henry, 141.
 James, 140.
 John, 140.
 Katherina, 140, 141.
 Katherina (Stone), 140.
 Maria, 140.
 Maria = Burdet, 141.
 Maria (Chawworth), 140.
 Maria (Rose), 140.
 Susanna (Wright), 141.
 Thomas, 140, 141.
 William, 140, 141.
Croftes, 21.
 Croftes, Anna = Meade, 151.
 William, 151.
 Croke al's Blount, 128.
 John, 128.
 Prudentia (Cave), 128.
 Croper — = Ashton, 198.
 Crowcest, Edward, 134.
 Croxton, Alice = Brooke, 65.
 William, 65.

Cruse, John, 17.
 Margery (Staresmore), 17.
 Mary = Grey, 17.
 Cudden, Francis, 174.
 Margareta = Noone, 174.
 Cumberland, Dorothea (Beaumont), 170.
 Curson, Briget = Burdet, 24.
 Elizabeth (Corbet), 177.
 Jocosa = Apleby, 11.
 „ = Lewes, 11.
 John, 45.
 Jone = Sacheverell, 45.
 Thomas, 11, 24.
 Vincent, 177.
 — = Ashby, 13, 132.
 — = Wigley, 97.
Cutler, 138.
 CUTLER, 138.
 Anna, 138.
 Arthur, 138.
 Elizabeth, 138.
 George, 138.
 Heath (Fish), 138.
 Henry, 138.
 James, 138.
 John, 138.
 Margaret = Dracott, 138.
 Margaret (Herne), 138.
 Maria, 138.
 Timothy, 138.
 Dabernon, Rob., 167.
 Maria = Temple, 167.
 Dacomb, John, 146.
 Alicia = Smith, 146.
 Dacon, Elizab. = Breton, 161.
 Dakins, Jana = Ap Rice, 117.
 Jana = Roberts, 117.
 Philip, 117.
 Dale, Elizab. = Hall, 204.
 Dall, Richard, 37.
 Margaret (Purifoy), 37.
 Dalley, Marg^t = Maye, 180.
 Dalton, Lawrence, *alias*, 27.
 Anne = Wrenne, 27.
 Constance = Lampton, 27.
 Elizab. = Hutton, 27.
 Jane (Redman), 27.
 Jane = Todd, 27.
 John, 27.
 Rafe, 27.
 William, 27.
 — (Strangwayes), 27.
Daniell, 70.
 DANNAT or DANNET, 64.
 Agnes (Allen), 51.
 Agnes (Belmeg), 64.
 Agnes (Peake), 64.
 Alice = Burnham, 64.
 Anne (Browne), 64.
 Anne (Ellingbridge), 64.
 Anne (Higford), 64.
 Audley, 64.
 Ellinor = Chambers, 51.
 Elizabeth = Arundell, 64.
 Elizab. = Bedford al's Sandy, 51.
 Elizabeth (Lenton), 64.
 Gerrard, 64, 192.
 Joane (de la Haye), 64.
 John, 51, 64, 192.

DANNAT—*continued.*

Juliana (Plantagenet), 64.
 Leonard, 64.
 Marg^t. (Skeirshall), 51.
 Mary (Belknap), 64.
 Mary = Medley, 64.
 Mawde (Knightley), 64.
 Mawde (Pickwell), 64.
 Richard, 64.
 Robert, 64.
 Sara (Caldwall), 192.
 Sir John, 64.
 Sir William, 51, 64.
 Thomas, 51, 64.
 Thomasin (Wheatley), 51.
 William, 64.
Dannet, 64.
 Dansey, John, 83.
 Margareta (Warde), 63.
Danvers, 86.
 DANVERS, 86.
 Agneta (—[?]—), 86, 87.
 Anne = Digbye, 40.
 Anne = Mulsho, 87, 155.
 Anne (Pury), 40.
 Alicia (Venables), 86.
 Bertram, 86.
 Brigetta (Werley), 87.
 Dorothea = Barford, 87, 178.
 Dorothy = Hubert, 40.
 Elizabeth = Cave, 40, 111, 126.
 Elizabeth = Skeffington, 111.
 Elizabeth (Skeffington), 87.
 Elizabeth (Babington), 87, 206.
 Elizabeth, 87.
 Francis, 86, 87.
 Isabella (Coke), 86.
 Jocosa = Barfoote, 86.
 Jocosa = Kendall, 86.
 John, 40, 86, 87, 126, 155, 178.
 Margaret (Kingston), 86.
 Margaret (Hamton), 40.
 Margaret (Shirley), 86.
 Margaret (Walcott), 86.
 Sir Thomas, 40.
 Thomas, 86.
 William, 86, 87, 206.
 Darell, Sir Edward, 8.
 Alice (S —[?]), 8.
 Darker, Henry, 200.
 Jane = Wase, 200.
 Dartnoll, John, 175.
 Katherin = Sterkie, 175.
 Davenport, John, 37.
 Jane = Purifoy, 37.
 Ursula (Cave), 122.
 William, 122.
 Davies, Alicia (Creekland), 117.
 William, 117.
Daves, 98.
 DAWES, 98.
 Beatrix = Woode, 98.
 Charitie (Lightfoote), 98.
 Daniell, 98.
 Ellena (Seller), 98.
 Elizabeth, 98.
 Elizabeth (Gerveis), 98.
 Gerveis, 98.

DAWES—*continued.*

- Isack, 98.
 John, 98.
 Joseph, 98.
 Margaret (Vernam), 98.
 Maria (Saunders), 98.
 Richard, 98.
 William, 98.
 Dawney, John, 26.
 Isabell (Shirley), 26.
 Dawney, John, 26.
 Isabell (Shirley), 26.
 Dawson, Johanna = Cooper, 90.
 Deane, Alicia (Wigley), 97.
 Brian, 110.
 James, 97.
 Joane = Cambridg, 110.
 Joane = Roose, 110.
 Decon, Clement, 100.
 Grace (Needham), 100.
 Deepcup, Anna = Allen, 195.
 Edward, 195.
 Deering, Richard, 111.
 — (Skeffington), 111.
 De la Fontaine, Erasmus, 4.
 Mary (Noell), 4.
De la Haye, 64.
 De la Haye, Joanne = Darnet, 64.
 Mawde (Knightly), 64.
 Thomas, 64.
De la Laund, 2.
 De la Laund, Jone = Denton, 2.
 Katherina (Wells), 2.
 Margaret = Berkley, 2.
 Thomas, 2.
 Delves, Alice (Brooke), 65.
 George, 65.
 Denbigh, E. of [Fielding], 4, 30.
 Denham Elina = Lawrence, 102.
 — (Hersie), 102.
 Dennis, Alicia = Berie, 207.
 Hugo, 207.
 Denston, Johanna = Maye, 180.
 Margaret = Cooper, 90.
 William, 90, 180.
 Dent, Alice = Cater, 1.
 Margaret (Dixson), 195.
 William, 1.
Denton, 2.
 Denton, Alice = Purifoy, 32, 35.
 Anne = Greville, 35.
 Isabell (Browne), 35.
 Jone (de la Laund), 2.
 Susanna (Temple), 168.
 Thomas, 2, 32, 35, 168.
Derby, 18, 183.
 DERBY, 18.
 Edward, 18.
 Elizabeth = Eyton, 183.
 John, 163.
 Libius, 174, 183.
 Lilius = ?, 18.
 Mary (Noone), 174.
 William, 163.
 Dercy, L^d [D'Arcy], 170.

Dercy—*continued.*

- Johanna = Beaumont, 170.
 Desmond, E. of [Fielding], 31.
 Dester — = Hackluit, 194.
 — = Mitton, 194.
 DETHICK, 88.
 Alicia = Sterkie, 88, 175.
 Ciculia (—?—), 88.
 Rowland, 88.
 Thomas, 88.
 William, 88, 175.
 Devereux, Barbara = Cave, 73, 128.
 Barbara = Hastings, 73.
 Barbara = Roper, 73.
 Dorothea (Hastings), 72.
 Dorothy = Shirley, 26.
 Maria (Gray), 75.
 Robert [E. of Essex], 26.
 Walter [Vis' Hereford], 72, 75.
 William, 73, 128.
 Dickinson, Agnitia = Vough, 194.
Digby, 40, 87.
 DIGBIE or DIGBY, 40, 41, 87, 199.
 Abrigall (Henningham), 41.
 Abigall, 41.
 Agnes (Clerk), 40.
 Agnes (Shilton), 40.
 Agnes = Tracy, 40.
 Agnes = Villers, 30.
 Alice, 40.
 Alice (Weles or Walleys), 40.
 Alice = Clifton, 40.
 Alice = Browne, 41.
 Ambrose, 41.
 Anne = Burton, 163.
 Anne (Danvers), 40.
 Anne = Skeffington, 8, 41, 111.
 Anne (Throckmorton), 41.
 Anne (Nicholson), 41.
 Anna = Lacy, 75, 180.
 Anna = Creach, 199.
 Anna, 40, 199.
 Anthony, 41.
 Beatrix (Walcott), 41.
 Briget = Sherard, 10.
 Dorothy (Oxenbridge), 40.
 Dorothy, 40.
 Edward, 199.
 Ellin (Wheeler), 41.
 Ellina (Secheverell), 199.
 Elizabeth = Humphrie, 40.
 Eliz. (Hartop), 197.
 Elizab. = St. Leger, 41.
 Elizab. = Vernam, 199.
 Elizabeth, 46, 87, 199.
 Emma, 199.
 Everard, 8, 41, 46, 111.
 Francis, 46.
 George, 41, 46.
 Henry, 87.
 Jana, 199.
 Jane (Bellers), 40.
 Jaquet (Ellis), 40.
 John, 30, 41, 46, 63, 75, 87, 111, 186, 197, 199.
 Katherin (Griffin), 40.

DIGBIE and DIGBY—*continued.*

- Katherin = Fisher, 41.
 Katherin = Meeres, 41.
 Keleme, 41.
 Kenolm, 80.
 Libbes, 40.
 Margaret (—?—), 87.
 Margaret, 41.
 Margery (Heyton), 41.
 Maria (Gegge), 87.
 Maria, 199.
 Mary, 41, 46.
 Mary (Neele), 46.
 Nathaniell, 199.
 Penelope, 199.
 Percivall, 40.
 Phillip, 41.
 Reignold, 40.
 Robert, 40.
 Rose (Prestwich), 63.
 Rowland, 40.
 Sara, 199.
 Sir Everard, 8, 46.
 Sir George, 41.
 Sir John, 8, 14, 40, 41.
 Sir Libbes, 40.
 Sir Robert, 41.
 Sir Thomas, 40.
 Symon, 41, 63.
 Symond, 40.
 Tabitha, 199.
 Thomas, 40, 87, 199.
 Ursula (Halfhead), 87.
 William, 40, 63, 199.
 — = Ashby, 14.
 — (Carlton), 199.
 — (Dixwell), 199.
 — = Drayton, 40.
 — = Bowles, 40.
 — (Hunt), 40.
 — = Strelley, 40.
 — = Gee, 180.
 — (Peto), 199.
 Diglin, Elina = Roberts, 118.
 Gilbert, 118.
 Dilkes, Anne (Fisher), 42.
 Dillingham, Henry, 195.
 Katherin = Allen, 195.
 Katherin (Marston), 101.
 William, 101.
 Dillon, Anna (Beaumont), 61, 171.
 John, 61, 171.
 Dingley, Richard, 6.
 — = Staresmore, 6.
 Disney, Mary (Nevill), 22.
 Dison, John, 85.
 Elizabeth (Pratt), 85.
Dixie, 116.
 DIXIE or DIXY, 116.
 Anna (Jephson), 116.
 Anna (Draper), 52, 116.
 Brigetta, 116.
 Brigetta (Rolt), 116.
 Brigetta (Bedell), 116.
 Charity, 116.
 Charity (Henson), 116.
 Dorothea = Barkor, 116.
 Elizabeth, 116.
 Francis, 116.
 Francisca (Beaumont), 61, 116, 171.

DIXIE or DIXY—*continued.*

Francisca (Throckmorton), 116.
 Francisca = Rolt, 116.
 Jana, 116.
 Jana (Crathorne), 116.
 Joanna (Walkden), 116.
 John, 116.
 Maria, 116.
 Richard, 116.
 Sir Wolstan, 52, 61.
 Thomas, 116.
 Walter, 116.
 William, 116.
 Wolstan, 116, 171.
 Yougus, 116.
 — (Bassingham), 116.
 — (Beridge), 116.
 DIXON or DIXSON, 195.
 Agneta, 195.
 Anna (Armestronge), 195.
 Anna (Dudley), 195.
 Audria = Astwell, 195.
 Dorothea (Bedell), 195.
 Dorothea (Everard), 195.
 Elizabeth (Peck), 148.
 Elizabeth (Pratt), 85.
 Friswold, 195.
 Henry, 148.
 Joanna (Cannon), 195.
 Joanna, 195.
 John, 85, 195.
 Jone = Bushby, 195.
 Margeria = Sharpe, 89, 195.
 Margareta = Dent, 195.
 Margareta (Howe), 195.
 Margeria, 195.
 Maria, 195.
 Maria (Brian), 195.
 Oliver, 195.
 Richard, 89, 195.
 Ruth, 195.
 William, 195.
Dixsey, 115.
 Dixsey, Sir Beaumont, 115.
 Dixwell, — = Digbie, 199.
 Barbara = Purifoy, 35.
 William, 35.
 Docura, Anthony, 82.
 Maria = Shipward, 82.
Doiley, 7.
 Doiley, John, 113.
 Roisia (Duston), 113.
 Donluer, Lord [Madonell], 30.
 Donne, Brice, 7.
 Jone = Cambridg, 7.
 „ = Roose, 7.
 Dorset, Marquis of [Grey], 74, 75.
 Dove, Dr., 106.
 — = Pochin, 106.
Downe, 7.
 Dracott, Jane = Noell, 113.
 John, 138.
 Margaret (Cutler), 138.
 Roger, 113.
Draper, 52.
 DRAPER, 52.
 Alice (Faunt), 28.
 Anne (Dixie), 52, 116.
 Benet = Fromond, 52.
 Bennet = Webbe, 52.

DRAPER—*continued.*

Briget = Woodroffe, 52.
 Christopher, 116.
 Elizabeth = Bowyer, 116.
 Elizabeth (Fifeild), 116.
 John, 116.
 Margaret (Greene), 116.
 Mathew, 116.
 Robert, 116.
 Sara (Blackwell), 116.
 Sir Christopher, 116.
 Thomas, 116.
 — (Agar), 116.
 — (Gunston), 116.
 — (Kettlebye), 116.
 Drayton, — (Digby), 40.
 Dreden, Erasmus, 133, 197.
 Francisca (Cave), 133.
 Maria = Hartop, 197.
 — = Berie, 207.
Dribly, 58.
 Dribly, Alice = Malory, 58.
 „ = Basset, 58.
 John, 58.
 Driver, Anna = Ruding, 104.
 John, 104.
 Dryden, Erasmus, 9.
 Mary = Hartop, 9.
 Duccombe, Sir John, 22.
 Alice = Smith, 22.
 Duck, Margeria (Sherman), 204.
 Duckett, Anna = Croft, 140.
 Elizabeth (Breton), 161.
 Francis, 161.
 Grace (Gerveis), 71.
 Henry, 182.
 John, 140.
 Noe, 71.
 Sara (Bainbrig), 182.
 Dudley, Anna = Dixon, 195.
 Edmond, 74.
 Edward, 195.
 Elizabeth = Grey, 74.
 „ = Plantagenet, 74.
 Gifford, 75.
 John [D. of Northumberland], 74.
 Jana (Gray), 75.
 Duncalph, — = Hollingsworth, 184.
Duport, 123. (Crest, 124.)
 DUPORT, 124.
 Alexander, 124.
 Anna = Polson, 124.
 Anne (Higate), 124.
 Cornelia (Norton), 124.
 Cornelia = Segrave, 124.
 Emma (Montague), 124.
 Eudochia, 124.
 Frances = Cave, 124, 127.
 Guillaume, 124.
 Henry, 124.
 Jaques, 124.
 Jean, 124.
 Katherina = Higate, 124.
 Margaret, 124.
 Maria = Plumbe, 121, 124.
 Thomas, 121.
 — (Cartier), 124.
 — (Claremont), 124.
 — (Galliard), 124.

DUPORT—*continued.*

— (Vincent), 124.
 Durant, Anne = Cave, 127.
 Gregory, 127.
 Margaret (Sherard), 10.
 William, 10.
 Dutton, Laurence, 60, 172.
 Isabella = Beaumont, 60, 172.
 Earle, Ann (Lovett), 4.
 Edward, 4.
 Eastwell, Agnes (Bent), 159.
 William, 159.
 Eastwick, Richard, 136.
 Lucia = Staveley, 136.
 Eaton, Edward, 18.
 Elizabeth (—?), 18.
 Mary (Ashby), 14.
 Ebney, Paul, 201.
 Maria (Brookesby), 201.
 Edward IV. [of England], 74.
 Eiton, — = Staresmore, 5, 99.
 Elkins, Thomas, 199.
 — = Ashton, 199.
 Eldrington, Edward, 26.
 Beatrix (Shirley), 26.
 Eli, Bishop of [Kirkby], 29.
Elkington, 153.
 ELKINGTON, 153.
 Anna, 153.
 Edward, 153.
 Egidius, 153.
 Elizabeth (Swynfen), 134, 153.
 Gracia = Marshall, 85.
 Henry, 153.
 Humphrie, 153.
 Johanna, 153.
 John, 85, 134, 153.
 Katherin = Gerveis, 118.
 „ = Robertes, 118.
 Magdalena (Parslow), 153.
 Maria, 153.
 Richard, 118, 153.
 Thomas, 85, 153.
 Elingbridge, Ann = Dannel, 64.
 Elliot, Eliz. (Neele), 46.
 Ellis, Anna (Sherrard), 10.
 Anthony, 10.
 Jacquet = Digby, 40.
 Jilian = Feilding, 40.
 John, 40.
 — = Gee, 181.
 Elmes, Elizab. = Halford, 145.
 Francis = Haselrigg, 16.
 Thomas, 145.
 Elrington, Jana = Brudnell, 143.
 Elwood, Elizabeth (Lacy), 75, 186.
 John, 75, 186.
Engane, 2.
 Engleby, Ric., *see* Ingleby, 112.
 Englefeild, *see* Inglefeild, 49.
 Sir Francis, 49.
English, 7.
 English, Margareta = Oldbeefe, 7, 110.
 Richard, 7.
 William, 110.

English—*continued.*

— = Winter, 42.
 Entwissell, Editha (Bracebridge), 15.
 Elizabeth (Stanton), 15.
 Lucia = Haselrigg, 15.
 Margareta = Brudenell, 143.
 Thomas, 15, 143.
 Erdeswicke, Mary (Neele), 46.
 Samson, 46, 131.
 — = Smith, 131.
 Erdiswicke, Jane, 46.
 Mathew, 46.
 Richard, 46.
 Erdwick, Alicia (Gregory), 187.
 Hugo, 187.
 Stephen, 187.
 Erse, — = Brasbridge, 43.
 Erselington, Robert, 15.
 — = Haselrigg, 15.
 Esick, Thomas [J. P.], 109.
 Esle, Edward, 59.
 Lucy (Harington), 59.
 Essex, Earl of [Devereux], 26.
 Etingdon, Henry of, 25.
 Eure, Lord [Eure], 4.
 Anne, 4.
 Elizabeth, 4.
 Francis, 4.
 Katherine, 4.
 Lucia (Noell), 4.
 Mary, 4.
 Margaret, 4.
 Ralph, 4.
 Sir William, 4.
 William, 4.
 Evans, Arthur, 127.
 Dorothea (Cave), 127.
Everard, 12, 50, 142.
 EVERARD, 12, 142, 175.
 Anna (Aston), 142.
 Anna = Bainbrig, 190.
 Anna = Mercy, 142.
 Anna = Webster, 142.
 Christopher, 13, 142.
 Dorothea (Dixson), 195.
 Elianora (Latham), 142.
 Elizabeth, 175.
 Elizabeth (Butler), 13.
 Elizabeth (Cockaine), 142.
 Elizabeth (Palladay), 142.
 Elizabeth = Watts, 175.
 Francisca (Reeve), 175.
 George, 175.
 Henry, 175.
 Hester, 142.
 Humphrie, 13.
 James, 142.
 Jana, 175.
 Jana (Babington), 175, 206.
 Jana = Gorston, 142.
 " = Rarwick, 142.
 Jana Madock, 142.
 Jane (Waterton), 80.
 John, 13, 142.
 Joice = Beresford, 13.
 Margareta (Marvin), 142.
 Margareta (Wolverston), 12, 142.
 Marmaduke, 142.
 Maria, 142.
 Maria (Rocke), 142.

EVERARD—*continued.*

Maria = Samson, 175.
 Maria = Snelling, 142.
 Peter, 142.
 Richard, 12, 13, 50, 80, 142, 175, 190.
 Robert, 12, 142, 175.
 Samson, 142.
 Stephen, 142, 175, 206.
 Thomas, 142, 175.
 William, 142, 195.
 — = Brudenell, 13.
 — (Langham), 12, 175.
 — (Latham), 175.
 — (Madox), 13.
 — (Whittington), 13.
 — = Woodlake, 13.
 Everingham, Katherin =
 Beaumont, 169.
 Margaret (Bouge), 54.
 Thomas, 54, 169.
 Everton, Henry, 168.
 Isabella = Temple, 168.
 Ewart, Elizabeth = Cave, 128.
 Paul, 128.
 Exeter, E. of [Cicell], 4.
Eyre, 193.
 EYRE, 193.
 Christopher, 193.
 Elizabeth, 193.
 George, 69.
 Henry, 193.
 Jervais, 193.
 John, 193.
 Margaret (Belgrave), 69.
 Richard, 193.
 Robert, 193.
 Roger, 193.
 Rowland, 193.
 Ruth, 193.
Eyton, 183.
 EYTON, 183.
 Anna = Pilkington, 183.
 Anthony, 183.
 Apulia, 183.
 Damoris, 183.
 Debora, 183.
 Edward, 183.
 Elizabeth (Derby), 183.
 Isaack, 183.
 Maria (Brasbridge), 183.
 Maria (Gray), 183.
 Mary (Ashby), 183.
 Presilla, 183.
 Richard, 183.
 Symon, 183.
 Farington, Hester (Smalley), 77.
 John, 77.
Farmer, 179.
 FARMER, 179.
 Bartholmeus, 179.
 Barthomeus, 179.
 Dorothea, 179.
 Edward, 179.
 Elizabeth, 179.
 Elizabeth (Borde), 179.
 Elizabeth (Hill), 179.
 Francis, 179.
 George, 179.
 Humphrey, 179.

FARMER—*continued.*

John, 168, 179.
 Katherine, 179.
 Lawrence, 179.
 Leticia, 179.
 Margeria (—?—), 179.
 Margeria, 179.
 Maria (Purifoy), 179.
 Maria (Temple), 168.
 Ralph, 179.
 Thomas, 179.
 Ursula (Mottes), 179.
 William, 179.
 — (Steines), 179.
 — (Wikeman), 179.
 Farnell, Anna = Carrington, 131, 145.
 Edmond, 131, 145.
Farnham, 77.
 FARNHAM, 77.
 Anna (Harrold), 77.
 Francis, 77.
 Johanna = Belgrave, 67, 77.
 John, 77.
 Katherin = Beaumont, 61, 171.
 Margareta (Kingston), 77.
 Margareta (Whatton), 77.
 Margeria (Cave), 77.
 Maria (Laughton), 77.
 Robert, 67, 77.
 Thomas, 77, 171.
 William, 77.
 Farrar, Henry, 186.
 Isabella = Lacey, 186.
 FARRENT, 202.
 Alicia (Cooney), 202.
 Anthony, 202.
 Elizabeth (Lumley), 202.
 Francis, 202.
 George, 202.
 James, 202.
 Johanna (Thorley), 202.
 Laurence, 202.
 Maria, 202.
 Maria (Cooper), 202.
 Martha (Marriot), 202.
 Richard, 202.
 Thomas, 202.
 — = Winter, 202.
 Farriant, Eliz. (Swynfen), 134.
Faunt, 28.
 FAUNT, 28.
 Alice, 28.
 Alice = Clarvaux, 28.
 Alice = Draper, 28.
 Alice = Purifoy, 28, 37, 121.
 Alice = Plumbe, 121.
 " = Purifoy, 121.
 Alice = Vincent, 50, 81.
 Anne (Feilding), 28.
 Anthony, 28, 81, 172.
 Arthur, 28.
 Barbara, 28.
 Barbara = Beaumont, 172.
 Dorothy = Burton, 28, 57.
 Elizabeth (Noell), 28, 114.
 Francis, 28.
 Griswold = Hales, 28.
 Henry, 28.
 Jane, 28.
 Jane (Vincent), 28, 50, 81.

FAUNT—*continued.*

John, 28.
 Judith, 28.
 Lucy (Harrington), 28.
 Mabill = Hastings, 28.
 Mary = Kerkin, 28.
 Sir William, 28.
 Thomas, 28, 81.
 Vincent, 28.
 William, 28, 37, 57, 121.
 — (Clarvaux), 28.
 — (Hide), 28.
 — (Moulton), 28.
 — (Moynes), 28.
 — (Scot), 28.
 — (Vincent), 28.
 Fauson, Agnes (Halford),
 144.
 Thomas, 144.
 Fawer, Henry, 75.
 Isabella = Lacy, 75.
 Fawknor, Anna = Trinnell,
 176.
 Feilding, Anna = Faunt, 28.
 Ann (Weston), 31.
 Ann, 31.
 Barbara = Cave, 128.
 Basil [L^d F., of Newnham
 Padox], 31.
 Elizabeth, 31.
 George [E. of Desmond],
 31.
 James, 31.
 Mary = Hamilton, 31.
 Margery (Purifoy), 33.
 Sir Everard, 40.
 Sir William, 28, 33.
 Sir William [E. of Denbigh],
 30.
 Susan (Villers), 30.
 William, 128.
 Felder, Clement, 143.
Fencotts, 21.
 Fencotts, Sir Thomas, 21.
 Ellena (Brudnell), 143.
 Fendern, Mary = Turvill, 55.
 Thomas, 55.
 Fenton, Elizab. (Malory), 58.
 John, 58.
 Ferne, Elizab. (Needham),
 146.
 John, 146.
 Fernwold, Anne (Shirley),
 26.
 Richard, 26.
 Ferrers, Anna = Gray, 74.
 Ellin = Turvill, 54.
 Elizabeth = Gray, 74.
 Humphry, 188.
 Jana = Gregorie, 188.
 John, 188.
 Lady Jane = Berkley, 2.
 Lord of Groby, 17.
 Robert [L^d of Titbury], 25.
 Robert [E. Ferrers and
 Darby], 2.
 Sir John, 54.
 William, Earl of, 25.
 Fetherston — = Brooke, 56.
 Fielding, Lady Ann = Noell, 4.
 [E. of Denbigh], 4.
 Fifeild, al's Lowe, John, 52.

Fifeild—*continued.*

Elizab. = Draper, 52.
 Findern, Averia (Beaumont),
 171.
 Thomas, 171.
 Fines, Ann = Villers, 30.
 Richard [Lord Say], 30.
 Fish, George, 138.
 Heath = Cutler, 138.
 Fisher, Anna = Dilkes, 42.
 Elizabeth = Goodman, 84.
 Elizabeth (Whaley), 148.
 Joane = Hartop, 9, 197.
 Katherine (Digby), 41.
 Letice, 42.
 Margaret (Repington), 42.
 Mary = Littleton, 42.
 Octavian, 9, 84, 194, 197.
 Sir Clement, 41, 42.
 Sir Robert, 42.
 Thomazin = Vough, 194.
 William, 148.
 Fishwick, William, 192.
 Johanna = Caldwell, 192.
 Fitz-Alan [E. of Arundel],
 165.
 Fitz-Harbert, Anthony, 33.
 Anne = Banister, 165.
 Editha = Babington, 205.
 Mary = Purifoy, 33.
 Nicholas, 165.
 Ralph, 205.
 Fitz-Randall, Ralph, 9, 196.
 Barbara = Hartop, 9, 196.
 Flacket, John, 143.
 Agnes (Brudnell), 143.
Flamvill, 53.
 Flamvill, Henry, 53.
 John, 53.
 Robert, 53.
 Thomas, 53.
 William, 53, 54.
 — = Turvile.
 Flanders, John, 44.
 Margaret = Whethill, 44.
Flaunders, 44.
 Fletcher, Margeria (Bent),
 159.
 Thomas, 159.
 Flint, Mary (Haselrigg), 16.
 Floker — = Sturton, 119.
 Flower, Dorothy (Coniers), 3,
 114.
 Jane (Plesington), 49.
 Roger, 49.
 Foljamb, Sir Godfrey, 22.
 Katherin = Nevill, 22.
Folville, 47.
 Folville, Emma = Bellers, 29.
 John, 47.
 Mabilla (—?—), 47.
 Mabill = Woodford, 47.
 Sir Walter, 29.
 — = Sherard, 10.
 Forman, Maria = Vincent,
 81.
 Richard, 81.
 — = Vincent, 50.
 Forster, Elizabeth = Bankes,
 150.
 Elizabeth (Haselrigg), 16.
 Richard, 150.

Forster—*continued.*

William, 134.
 — = Bradshawe, 44, 161.
 Foucher, John, 53.
 Margaret (Champion), 53.
 — = Bouge, 54.
 Foulchurst, Sir Robert, 54.
 Elizabeth = Turvile, 54.
 Foulke, Cassandra = Staes-
 more, 5.
 Johanna (Leveson), 111.
 William, 111.
 Fowcher, Alice, 53.
 Avis, 53.
 Edmond, 53.
 Jane, 53.
 Marian, 53.
 Robert, 53.
 Fowler, Anne = Noell, 3,
 114, 140.
 Barbara (Harvy), 140.
 Elizabeth (Neele), 164.
 Hogo, 164.
 John, 3, 114, 140.
 Margaret = Beresford, 179.
Fox, 149.
 FOX, 149.
 Agneta (Hill), 149.
 Barbara = Beardmore, 149.
 Briget (Ashby), 14.
 Elizabeth (—?—), 149.
 Elizabeth (Barret), 107.
 Elizabeth (Sprott), 149.
 Elizabeth (Stamford), 149,
 160.
 George, 149.
 Henry, 200.
 John, 149.
 Margaret (Wase), 200.
 Nicholas, 149.
 Richard, 149.
 Robert, 107.
 Samuel, 149.
 Thomas, 149.
 William, 149, 160.
 Foxley, Jana (Halford), 144.
 Katherine (Cotes), 94.
 Nicholas, 94, 144.
 Foxston, Nicholas, 36.
 — (Pell), 36.
 Frampton, Richard, 24.
 Mary (Burdet), 24.
 Francis, Cicilye = Fowcher,
 53.
 Elizabeth = Charnells, 123.
 Jane — = Burdet, 24.
 John, 24, 49, 53.
Vel Plesington, 49.
 William, 24.
 Frank, Joanna = Brookesby,
 201.
 Thomas, 201.
 Franklin, Francisca (Roberts),
 203.
 John, 203.
 — = Gregorie, 189.
 Fransum, Katherin (Strelley),
 194.
 Thomas, 194.
 Frearch, Elizab. (Lacy), 186.
 Thomas, 186.
 Freeman, Alicia (Bent), 159.

Freeman—*continued.*

- James, 204.
John, 159.
Susanna = Hall, 204.
— = Brudnell, 143.
Freford, Thomas de, 133.
Fresby, Jane (Swynfen), 134.
John, 134.
Frier, Elizab. = Cooper, 90.
Robert, 90.
Frisby, Felicia = Warde, 83.
John, 83.
Fromond, Benet (Draper), 52.
John, 52.
Frost, John, 19.
Margaret (Legard), 19.
Fulcher Son of Sewall, 25.
Fulcher, Sewall son of, 25.
Fuliambe, Mary (Villers), 29.
— = Plumpton, 29.
Fulk, Cassandra = Staresmore, 99.
Fulwood, John, 4, 114.
Francisca = Noell, 4, 114.
Furtho, Anne = Purifoy, 36.
Anthony, 136.
- Gage, Clement, 104.
Jane (Ruding), 104.
Galliard — = Duport, 124.
Gamble, Anna = Needham, 100.
Joanna = Bale, 141.
Richard, 100.
Gardiner, Henry, 133.
Garret, Ellinore = Allen, 109.
John, 109.
Maria = Chippingdale, 157.
William, 167.
Garshull, Elizab. = Burdet, 23.
Robert, 23.
Garstangs = 62.
Garton, Elizab. (Whaley), 148.
Robert, 148.
Gaunt, John of, 120.
Geary, Anna (Banister), 165.
Jane (Robertes), 118.
Nicholas, 118.
William, 165.
Gedney, Andrew, 123.
Anna (Bickerton), 168.
Elianor = Ashby, 13.
Maria = Ashby, 123.
Thomas, 168.
— = Segrave, 18.
- Gee*, 180.
GEE, 180, 181.
Alexander, 180.
Anna = Legard, 181.
Anna = Pudsey, 181.
Anna (Savage), 181.
Briget, 181.
Edmund, 180.
Elianor, 181.
Elizabeth (Hart), 181.
Elizabeth (Hawbark), 180.
Elizabeth (Jobson), 181.
Elizab. (Stephens), 181.
Eustace, 181.
Francisca, 181.

GEE—*continued.*

- Grace (Baskerville), 180.
Henry, 180.
John, 180, 181.
Jone = Ives, 181.
Richard, 180.
Robert, 180.
Roger, 180.
Samuel, 181.
Thomas, 180.
Thomazim (Hutton), 81.
Ursula (Nevill), 180.
Walter, 181.
William, 181.
— (Digbie), 180.
— (Ellis), 181.
— (Poole), 180.
— (Villiers), 180.
Geerie — = Swynfen, 134.
Gegge, Maria = Digby, 87.
Raphe, 87.
Gell — = Wigley, 97.
Genill al's Gilliott, 125.
Maria = Cave, 125.
Peter, 125.
George, Elizab. = Temple, 167.
John, 167.
- GERVEIS, 71.
Alicia (Holyoke), 71.
Anna (Purefoy), 71.
Anna = Ward, 71.
Dorothea = Robertes, 118.
Edmund, 71.
Elizab. = Bradgate, 71.
Elizabeth = Dawes, 98.
Elizab. (Henshaw), 71.
Elizab. (Shepard), 71.
Francisca (Marson), 71.
George, 71, 98.
Grace = Ducket, 71.
Johanna = Payne, 71.
John, 71.
Katherin = Burdet, 71.
Katherin (Elkington), 118.
Katherina (Ward), 71.
Marg^t (Goodman), 71.
Ralph, 71.
Robert, 71.
Thomas, 71.
William, 71, 118.
- Gibbons, Marg^t = Bradshawe, 161.
Gibon, Matilda = Burton, 57.
Robert, 57.
— = Bradshawe, 44.
Gibson, Mary = Pilkington, 78.
Richard, 78.
- Gifford, Anna = Smith, 131.
Dorothea = Congrave, 26.
Dorothea = Shirley, 26.
Edward, 111, 175.
George, 181.
Johanna (Leveson), 111.
Jocosa (Nicolls), 187.
Maria (Everard), 175.
- Gilbert*, 189.
GILBERT, 189.
Agneta (Meade), 151.
Elizabeth = Cooke, 189.
Elizabeth = Cooper, 90.

GILBERT—*continued.*

- Francis, 189.
Hugo, 189.
Maria, 189.
Maria (Hoode), 189.
Mathew, 189.
Sara = Wellock, 189.
Thomas, 151, 189.
William, 90, 189.
- Giles, Chancy al's, 118.
Gill, Goditha = Wigley, 97.
Mary (Turvile), 55.
Gillett, Hellena = Cotes, 94.
Jone = Salisberie, 185.
Robert, 94.
Gilliot, Genill al's, 125.
Gillott, Nicholas [Mayor of Leicester], 109.
Gilman, Henry, 6.
Jane (Staresmore), 6.
Gladwyn, Ann (Morton), 184.
George, 184.
Glen, Ellina (Abney), 153.
John, 153.
- Glene*, 68.
Hugh, 68, 96.
Katherina, 68.
Katherin = Belgrave, 96.
Glossop, Elizab. = Whaley, 148.
William, 148.
- Gloucester, Robert, E. of [Clare], 74.
Glover, Agnes (Cowper), 152.
Anna = Bradshaw, 44, 161.
Jana (Robertes), 203.
Maria = Robertes, 203.
Thomas, 203.
- Gobson*, 69.
Goddard, 190.
GODDARD, 190.
Alicia, 190.
Anna (Bickerton), 173.
Anna, 190.
Elizab. (Pembleberie), 190.
Henry, 190.
John, 168, 190.
Katherina, 190.
Margeria (Gregson), 190.
Maria, 190.
Maria (Blewett), 190.
Thomas, 190.
William, 190.
— = Bent, 158.
- Goderich — = Marston, 101.
Goistock, Dorothy (Belgrave), 69.
John, 69.
- Golde, Prudence (Brasbridge), 43.
Gomond, Jana = Roberts, 117.
Goodall, Anne = Swynfen, 134.
Elizabeth (Croft), 140, 141.
Hugo, 140, 141.
Richard, 37.
Susanna (Purifoy), 37.
- Goodier, Henry, 174.
Katherina = Noone, 174.
- GOODMAN, 84.
Anna = Hartop, 9, 84, 197.

GOODMAN—*continued.*

- Anna = Sawier, 84.
 Elizabetha, 84.
 Elizabeth (Fisher), 84.
 Elizabeth (Whaley), 84.
 Everard, 84.
 Francis, 207.
 Francisca, 84.
 George, 84.
 Jana (Hales), 84.
 John, 84.
 Laurence, 84, 159.
 Margareta = Bent, 84, 159.
 Margaretta (Pratt), 84.
 Margaret = Gerveis, 71.
 Maria (Berye), 207.
 Maria, 84.
 Richard, 84.
 Thomas, 71, 84.
 Valentine, 84.
 William, 9, 84, 197.
 Goodwin, Blendina = Purifoy, 36.
 Edmond, 201.
 Elizabeth = Brookesby, 201.
 Isabell (Purifoy), 35.
 Thomas [Bp. of Bath and Wells], 36.
 Goodwyn, Cicely = Purifoy, 33, 36.
 John, 33, 36.
 GORE, 85.
 Anthony, 85.
 Charles, 85.
 Dorothea, 85.
 Edward, 85.
 Elizabetha, 85.
 Elizabeth (Cardwell), 85.
 Francisca (Marshall), 85.
 Gracia, 85.
 Grissell (Latham), 85.
 Henry, 85.
 Johanna = Pratt, 85.
 John, 85.
 Jonathan, 85.
 Margareta (Bletsho), 85.
 Maria, 85.
 Thomas, 85.
 — (Bailes), 85.
 — (Chapman), 85.
 — (Sabin), 85.
 Gorges, Francis = Heselrigg, 16.
 William, 16.
 Gorston, Jane (Everard), 142.
 Nicholas, 142.
 Goslinge — (Whethill), 45.
 Gottes, John, 194.
 Jana (Strelley), 194.
 Gourdon, Anna = Wincoll, 156.
 John, 156.
 Gramer, Francis, 152.
 Elizab. Cowper, 152.
Gray, 74.
 GRAY, 74, 75.
 Anna (Ferrers), 74.
 Anna (Windsor), 75.
 Anna (Rockley), 74.
 Anthony, 177.

GRAY—*continued.*

- Catherina (Percy), 74.
 Catherina = Seimer, 75.
 Cicilia (Bonvile), 74.
 Constantia (Holland), 74.
 Dorothea (Cave), 128.
 Edmond, 74.
 Edward, 74.
 Elianore = Cave, 128.
 Elinor (Strange), 74.
 Elizabeth (Hastings), 74.
 Elizabeth (Talbot), 74.
 Elizabeth (Ferrers), 74.
 Elizabeth (Woodvile), 74.
 Elizabeth (Dudley), 74.
 Elizabeth = Courtney, 74.
 Elizabeth (Nevill), 75.
 Elizabetha, 75.
 Francisca (Brandon), 75.
 Francisca = Cooke, 75.
 Gracia = Ward, 177.
 Henry, 74, 75.
 Humphrey, 128.
 Jone (Ashley), 74.
 John, 74, 75.
 Juna = Dudley, 75.
 Lady, Eva, 21.
 Margaret (Roos), 74.
 Margareta (Wotton), 74.
 Maria = Browne, 75.
 Maria = Devereux, 75.
 Maria, 75.
 Matilda (Basset), 74.
 Matilda (Boutort), 74.
 Maude = Nevill, 21.
 Munell (Howard), 74.
 Phillipa, 75.
 Reginald, 74.
 Robert, 74.
 Roger, 74.
 Thomas, 74, 128.
 Greene, Barbara (Harecourt), 108.
 Henry, 52.
 Margaret = Cooke, 108.
 Margaret = Draper, 52.
 Thomas, 108.
 — = Smith, al's Nevill, 22.
Gregory, 187.
 GREGORY, 187, 188, 189.
 Ada, 187.
 Alicia (Cawley), 188.
 Alicia, 189.
 Alicia = Erdswick, 187.
 Alionora (Billesby), 188.
 Anthony, 189.
 Arthur, 188.
 Christopher, 188.
 Edmond, 188, 189.
 Elizabeth, 188.
 Elizabeth = Leigh, 174.
 Elizabeth (Wade), 188.
 Francis, 188.
 Francisca, 189.
 Francisca (Baker), 189.
 Hellena (Malin), 188.
 Henry, 188.
 Isabella (Segrave), 188.
 Jana (Clarke), 189.
 Jana (Ferrers), 188.
 Johanna (Billesby), 188.
 John, 187, 188, 189.

GREGORY—*continued.*

- Laurence, 189.
 Leonard, 189.
 Margareta (—?—), 188.
 Margareta (Alsop), 189.
 Maria, 189.
 Matilda (Pekulton), 187.
 Nicholas, 187.
 Ralph, 188.
 Richard, 187, 188.
 Robert, 188.
 Thomas, 188, 189.
 Walter, 187.
 William, 174, 188, 189.
 — (Bosworth), 188.
 — (Franklin), 189.
 Gregory, John, 190.
 Margeria = Goddard, 190.
 Greisley, Briget (Burdet), 24.
 Sir George, 24.
 Thomas, 24.
 Grevill, Anna (Denton), 35.
 Sir Edward, 35.
 Sir Foulk, 35.
 Sir John, 35.
 Greville, Lady Dorothy = Haselrigg, 16.
 [Jord Brooke], 16.
 GREY, 17, 139.
 Anna (Blannerhasset), 139.
 Anna (Woodvile), 139.
 Anthony, 37, 139.
 Benedicta (—?—), 17.
 Charles, 139.
 Christiana, 139.
 de Ruthlin, Lord, 74.
 Dorothy (Cave), 17.
 Dorothea = Pochet, 17.
 Edmond [E. of Kent], 17, 139.
 Edward [L^d Ferrers of Goby], 17.
 George, 139.
 Gracia = Warde, al's Farmer, 139.
 Henry, Lord, 76.
 Henry, 139.
 Humphrey, 17.
 Job, 139.
 John, Lord, 17.
 John, 17, 139.
 Jone (Astley), 17.
 Katherin (Herbert), 139.
 Katherin (Percy), 139.
 Lancelott, 17.
 Leonard, 17.
 Magdalena (Purifoy), 139.
 Magdalena, 139.
 Margaret (de Roos), 17.
 Margeria (St. John), 139.
 Margeria (Staresmore), 6.
 Mary (Cruse), 17.
 Mary = Eyton, 133.
 Mary = Staresmore, 17.
 Mawdelain (Purifoy), 37.
 Nathaniell, 139.
 Patientia, 139.
 Priscilla, 139.
 Regnold, 17.
 Reignold, Lord, 17.
 Reignold, 17.
 Reginald, 139.

GREY—*continued.*

- Richard, 139.
 Robert, 17.
 Theophilus, 139.
 Thomas, 17.
 — = Harebottle, 17.
 — (Holland), 139.
 — (Hussi), 139.
 — (Salvaine), 139.
 Griffin, Bridget = Haselrigg, 16.
 " = Lane, 16.
 Edward, 56.
 Frances = Smith, 66.
 Jane = Kebell, 56.
 Katherin = Digby, 40.
 Nicholas, 40.
 Sir Edward, 30.
 Sir Nicholas, 22.
 Sir Thomas, 66.
 Thomas, 16.
 — = Nevill, 22.
 — = Villers, 30.
Griffith, 205.
 GRIFFITH, 205.
 Alicia (Barnard), 205.
 Alicia (Preston), 205.
 Alicia, 205.
 Elizabeth = Middleton, 205.
 Elizabeth (Skeffington), 111.
 George, 111, 205.
 Francis, 205.
 Margaret, 205.
 Maria, 205.
 Maria (Bent), 205.
 Phillip, 205.
 Rebecca, 205.
 Robert, 205.
 Theophilus, 205.
 Walter, 205.
 William, 205.
 Grigge, Dorothea (Overton), 193.
 John, 193.
 Margery (Mulsho), 155.
Grimsby, 12, 50.
 Grimsby, Alice = Vincent, 59.
 Anne (Moton), 12, 50, 59, 80.
 Anne = Vincent, 12, 50, 80.
 " = Waterton, 12, 50, 80.
 Elizab. = Montgomery, 50.
 Thomas, 12, 50, 80.
 William, 12, 50, 59, 80.
 — (Harebert), 80.
 — (Harecourt), 50.
 Grisley, Katherin = Winter, 42.
 Sir William, 42.
 Groome — = Wincoll, 156.
 Grunday, Margeria (Bent), 158.
 Nicholas, 158.
 Guest, Edward, 161.
 Etheldreda (Newham), 100.
 Elizabeth = Breton, 161.
 Katherin = Breton, 152.
 " = Wright, 152.

Guest—*continued.*

- Phillip, 100.
 Guerdin, Camilla = Harvy, 22.
 Vincent, 22.
 Guilford, Elizabeth = Shirley, 26.
 Sir Richard, 26.
 Gunston — = Bent, 159.
 — = Draper, 52.
 Gunter, Charles, 55.
 Jane (Turvile), 55.
 Hacker, Katherine (Stanford), 160.
 Richard, 160.
 Hackluit — = Dester, 194.
 Haldenby, Joane = Legard, 19.
 Hales, Griswold (Faunt), 28.
 Jana = Goodman, 84.
 John, 28.
 Halfeheade, Ursula = Digby, 82.
 HALFORD, 144, 145.
 Agnes = Fauson, 144.
 Andrew, 144.
 Anthony, 144.
 Dionisia (Bury), 144.
 Dionisia = Sprigge, 144.
 Edward, 144.
 Elizabeth, 144.
 Elizabeth (Bussy), 145.
 Elizabeth (Elmes), 145.
 Emma = Bale, 142, 144.
 Emma, 144.
 George, 144.
 Gracia (Brodgate), 144.
 Gracia = Bussie, 144.
 Henry, 144.
 Isabella (Bowman), 144.
 Jana, 145.
 Jana (Foxley), 144.
 Jana (Saunders), 145.
 Johanna (Barret), 144.
 Johanna (Coleman), 144.
 Johanna, 144.
 John, 144, 145.
 Nicholas, 144.
 Richard, 144.
 Roger, 144.
 Thomas, 145.
 William, 142, 144, 145.
 — = Henson, 144.
 Haliford — (Bradshaw), 44.
Hall, 204.
 HALL, 204.
 Anna = Banister, 165.
 Anthony, 204.
 Elinor (Vincent), 81.
 Elizabeth (Dale), 204.
 Elizabeth = Parker, 204.
 Elizabeth (Smith), 67.
 Henry, 204.
 James, 204.
 John, 67.
 Jone = Neele, 46.
 Maria, 204.
 Maria = Bankes, 150.
 Maria (Collins), 204.
 Martha, 204.
 Martha (Lumley), 204.

HALL—*continued.*

- Mary = Berkley, 3.
 Richard, 204.
 Robert, 165.
 Sara, 204.
 Susanna (Freeman), 204.
 Thomas, 204.
 Weblin, 204.
 William, 204.
 — = Mackworth, 46.
 — (Neele), 46.
 Halton, Maria = Warde, 83.
 Roger, 83.
Hamelyn, 2.
 Hamilton, James, 31.
 Mq^{ss} of, 31.
 Hamon, Cisley = Thame, 130.
 John, 130.
 Hampden, Anna (Cave), 126.
 Griffith, 126.
 Hampton, Robert de, 76.
 Hamton, Margaret = Davers, 40.
 William, 40.
 Hancock, Fulke, 173.
 Dorothea (Bickerton), 173.
 Harebert — = Grimsby, 80.
 Harebottle — (Grey), 17.
Harcourt, 166.
 HARCOURT or HARE-COURT, 39, 166.
 Alicia (Noel), 113.
 Anne, 39.
 Anna = Beaumont, 170.
 Anthony, 39, 198, 165, 166.
 Barbara = Greene, 108.
 Dorothy, 39.
 Dorothy (Hardwick), 39, 165, 166.
 Edward, 39, 166.
 Elizabeth, 166.
 Elizabeth (Leigh), 39, 166.
 Elizabeth = Brasbridge, 43.
 Francis, 166.
 George, 39, 166.
 Hanna, 166.
 Jane (Palmer), 39, 166.
 John, 18.
 Jone = Tew, 166.
 Margaret, 166.
 Margareta (Shukbrough), 166.
 Maria, 166.
 Richard, 113.
 Sir Robert, 43.
 William, 39, 113, 166.
 — = Cater, 39.
 — = Grimsby, 50.
 — = Motton, 59.
 — (Shugborowe), 39.
 Hardwick, Anna (Appleby), 11.
 Anne (Langham), 12, 42.
 Anne = Winter, 42.
 Dorothea = Banister, 165.
 Dorothea = Harcourt, 39, 165, 166.
 Edward, 53.
 Elizabeth = Burton, 57, 120.
 Elizabeth (Champion), 53.

Hardwick—*continued.*

- John, 11, 12, 34, 37, 39, 42, 57, 120, 166.
 Joyce = Purifoy, 34, 37.
 Thomas, 108.
 — = Harecourt, 108.
 Harwell, Agneta = Smith, 131, 146.
 John, 131, 146.
 — = Burdet, 24.
 Harkes, Garbrand, 157.
 Elizab. = Chippingdale, 157.
 Harper, Dorothea = Overton, 193.
 Elizab. (Noel), 4.
 Maria = Shirley, 26.
 Sir John, 4.
 Thomas, 26.
 Harpur, Isabell = Sherard, 10.
 Sir John, 10.
 Harrington or Harington.
 Anne (Keloway), 59.
 Ellina (Pochin), 106.
 Elizabeth (Motton), 59.
 Francis = Chichester, 59.
 James, 73, 80, 114.
 Jane = Villers, 31.
 John, Lord, 59.
 John, 31, 146.
 Johanna = Peck, 146.
 Lord Bonville and, 72.
 Lucy = Erle, 59.
 Lucy = Faunt, 28.
 Lucy (Sidney), 59.
 Mabel = Noell, 3, 114.
 Margaret = Barkley, 2.
 Richard, 106.
 Sara = Hastingses, 73.
 Sara = Kings, 73.
 Sara = L^d Zouch, 73.
 Sir James, 3, 59, 28.
 Sir John, 2, 59.
 Harris, Margareta (Bankes), 150.
 Harrison, Anna Maria (Peck), 148.
 William, 148.
 Harrold, Ann = Farnham, 77.
 Henry, 77.
 Hart, Elizabeth = Gee, 181.
Hartop, 196.
 HARTOP, 9, 196, 197.
 Alexander, 9, 196.
 Anna (Porter), 9, 196.
 Anne (Goodman), 9, 84, 197.
 Anne, 9, 197.
 Audria, 196.
 Autheria, 9.
 Barbara (Fitz Randall), 9.
 Barbara (Fitz Randolph), 196.
 Briget (Mason), 9, 197.
 Christian (Williams), 9, 196.
 Dorothea (Bendish), 197.
 Edward, 9, 197.
 Ellen (—?—), 9, 196.
 Elianor (Adcot), 9, 197.
 Elianor, 197.
 Elizabeth, 9, 197.

HARTOP—*continued.*

- Elizabeth = Bale, 9, 141, 197.
 Elizabeth = Clerkson, 197.
 Elizabeth = Digby, 197.
 Francisca, 197.
 George, 9, 197.
 Grace (Blewet), 9.
 Henry, 9, 196.
 Isabell = Blesby, 9, 196.
 Jane (Inglebeard), 9, 196.
 Joane = Fisher, 9, 197.
 John, 9, 196.
 Jone = Stret, 9, 197.
 Judith, 9.
 Juditha = Jack, 197.
 Margareta (Bridemaine), 9, 196.
 Margaret = Brokesby, 196.
 Margaret = Broxby, 9.
 Maria, 197.
 Maria (Dreden), 197.
 Mary (Dryden), 9.
 Mary = Lebourne, 9, 196.
 Mary (Rolt), 9, 197.
 Mary = Stringer, 9, 197.
 Marion, 9, 196.
 Phillippa = Holleys, 9, 196.
 Precilla = Cooke, 9, 196.
 Ralph, 9, 196.
 Richard, 9, 197.
 Robert, 9, 196.
 Samuell, 9, 197.
 Sir William, 9.
 Susan, 9.
 Susan = Odingsells, 197.
 Thomas, 9, 76, 197.
 Ursula = Ashley, 9.
 Valentine, 9, 84, 141, 196.
 William, 9, 84, 197.
 — (Allen), 9, 197.
 — (Cave), 9, 197.
 — (Chamberlayne), 9, 197.
 — (Moynes), 9, 196.
 — (Pratt), 9, 197.
 Harvy, Audrye (Humphrey), 62.
 Barbara = Fowler, 140.
 Camilla (Guierdin), 22.
 Dorothea = Croft, 140.
 Elizabeth, 22.
 Elizabeth = Vincent, 79.
 Francis, 22, 109, 146.
 Gertrude = Cater, 1.
 Johanna = Heselrig, 140.
 Johanna (Burdet), 140.
 John, 22.
 Lucia = Cotton, 140.
 Maria (Nevill), 146.
 Phillipa (Willoughby), 140.
 Richard, 62.
 Thomas, 140.
 Haselden, Margareta = Peck, 146.
Haselrig, 15, 70.
 HASELRIG [or Hasilirigg, or Haselrigge, or Hasillridge, or Heselrigg, etc.], 15, 16.
 Anne = Catesby, 15.
 Anne (Southill), 15.

HASELRIG—*continued.*

- Anne (Nicolls), 16, 187.
 Anna = Hunt, 16.
 Anne = Waite, 16.
 Anthony, 16.
 Arthur, 16.
 Austrius, 16.
 Bartram, 15.
 Bertinus, 16.
 Briget (Griffin), 16.
 Brigetta = Alicock, 16.
 Donaldus, 16.
 Dorothy (Greville), 16.
 Editha = Thorney, 16.
 Edward, 16.
 Elizabeth = Colingwood, 15.
 Elizabeth (Shirley), 15.
 Elizabeth (Stanton), 15.
 Elizabeth = Forster, 16.
 Frances (Brocas), 16.
 Frances (Gorges), 16.
 Francis, 16.
 Francis (Elmes), 16.
 Francis = Wood, 16.
 Gulielmus, 15.
 Herald = Williams, 15.
 Hugo, 140.
 Isabell (Heron), 15.
 Jana, 16.
 Jane = Wedgwood, 16.
 Johanna (Harvy), 140.
 John, 15, 16.
 Katherina = Ashley, 15, 132.
 Katherine, 16.
 Lucia (Entwisell), 15.
 Mabilia (Broket), 15.
 Maria, 16.
 Maria = Nudigate, 16.
 Maria = Rouse, 16.
 Mary = Blith, 16.
 „ = Flint, 16.
 „ = Plum, 16.
 Miles, 16.
 Milicent = Kebell, 15, 56.
 Rebecca, 16.
 Rebecca (Shefe), 16.
 Robert, 15.
 Sir Arthur, 16, 70.
 Susanna, 16.
 Symon, 15.
 Thomas, 15, 16, 56, 129.
 Ursula (Andrewes), 16.
 William, 15, 132.
 — (Esselington), 15.
 — (Neale), 15.
 — = Skeffington, 111.
 Haselwood — (Marmion), 78
 [in a note].
Hastings, 72.
 HASTINGS, 72, 73.
 Alicia, 73.
 Anna = ?, 72.
 Anna (Stafford), 72.
 Anna = Stanley, 72.
 Barbara (Devereux), 73.
 Dorothea = Devereux, 72.
 Dorothea (Post), 73.
 Edward, Lord, 72.
 Edward, 73.
 Elizab. = Beaumont, 6, 172.

HASTINGS—*continued.*

Elizabeth = Gray, 74.
 Elizabeth = Somerset, 73.
 Elizabeth (Stanley), 73.
 Ferdinando, 73.
 Francis, 72, 73.
 Francisca = Compton, 73.
 George, 72, 73.
 Henry, 28, 73.
 Isabell (Sodington), 15.
 Jane (Sheffield), 26.
 Jocosia = Roper, 73.
 John, 74.
 Katherin = Brandon, 73.
 Katherina = Chetwin, 73.
 „ = Umpton, 73.
 Katherin (Nevill), 72.
 Katherin = Percy, 73.
 Katherin (Poole), 72.
 Katherin = Stanhope, 73.
 Lord, 60.
 Mabill (Faunt), 28.
 Margaret = Broket, 15.
 Maria (Hungerford), 72.
 Matilda (Longford), 73.
 Ralph, 15.
 Richard, 72.
 Sara (Harington), 73.
 Sir Edward, 28.
 Thomas, 72.
 Walter, 73.
 William, Lord, 72.
 William, 26, 60, 72, 172.
 — (Willoughby), 73.
 Hatfield — (Yorksheir), 80.
Hauberk, 10.
 Hawbark, Elizab. = Gee, 180.
 John, 180.
 Hawes, Anna = Marston, 101.
 Margareta = Marston, 101.
 William, 101.
 Hawkins, Elizab. (Smith), 132.
 Thomas, 132.
 Hayes, Isabella = Lawrence, 102.
 Heath, Elizab. = Whiting, 92.
 Richard, 92.
 Heirik, Cicely (Ashby), 14.
 Helmsted, Anna = Caldwell, 192.
 Heltons, Baron of, [Wells], 2.
Helwell, 10.
 Helwell, Margarit = Sherard, 10.
 Sir John, 10.
 Heminges, Maria = Bagsham, 187.
 „ = Nicolls, 187.
 Hemingham, Abigall, 41.
 Sir Anthony, 41.
 Hemming, Faith (Sherman), 104.
 Henry, 204.
 Hemsley, Dorothea (Mountney), 179.
 William, 179.
 Henshaw, Elizab. = Gerveis, 71.
 Michell, 71.
 Henson, Charity = Dixy, 116.
 Elizab. = Walker, 137.

Henson—*continued.*

Robert, 144.
 Thomas, 116.
 — (Halford), 144.
 Herbert, William [E. of Pembroke], 139.
 Hereford, V^t [Devereux], 72, 75.
 Herick, Elizabeth (Yarde), 91.
 Francis, 91.
 Francisca = Noble, 115.
 John, 91.
 Maria, 91.
 Robert, 91, 115.
 Thobias, 91.
 William, 91.
 Hერიell, Katherin = Carrington, 145.
 Thomas, 145.
 Heritage, Alicia = Temple, 168.
 John, 168.
 Herne, Henry, 138.
 Margareta = Cutler, 138.
 Heron, Anna = Savill, 93.
 Edward, 93.
 Isabell = Haselrig, 15.
 Jana = Smith, 66.
 Roger, 15.
 Sir Edward, 66.
 Hershie, John, 102.
 — = Denham, 102.
 Hertford, Earl of [Seymour], 75.
 Hewett, Thos., 159.
 Ursula (Bent), 159.
 Heyton, Sir John, 41.
 Margery = Digby, 41.
 Heyward, Gabriell, 123.
 — (Charnells), 123.
 Hichinson, Ellin (Neale), 164.
 William, 164.
 Hickson — = Robertes, 117.
 Hide, George, 28.
 Katherin = Baghot, 151.
 Richard, 151.
 — = Faunt, 28.
 Hidson, Jana = Pate, 89.
 Higate, Ann = Duport, 124.
 Elizabeth = Berie, 207.
 Guillaum, 124.
 Katherin (Duport), 124.
 Thomas, 124.
 Higatt — = Porte, 48.
 Higford, Ann = Dannat, 64.
 Hill, Agneta = Fox, 149.
 Alice (Bailey), 200.
 Audria (Merihurst), 149.
 Dorothea (Beaumont), 171.
 Edward, 91.
 Elizabeth = Farmer, 179.
 John, 91, 149.
 Margeria (Yarde), 91.
 Maria, 91.
 Thomas, 91.
 William, 91, 200.
 Hilliard, Isabella = Legard, 19.
 Piers, 19.
Hinde, 21.
 Hinde — = Turvile, 55.
 Hix, Baptist, 114.
 Elizabeth = Noel, 114.

Hix—*continued.*

Julian = Noel, 4.
 Sir Baptist, 4.
 Hobson — = Needham, 100.
Hodges, 154.
 HODGES or HODGIS, 154.
 Anna = May, 154.
 Anna (Warde), 83, 154.
 Dorothea (Poultney), 154.
 Francis, 83, 154.
 John, 154.
 Leticia (Ashton), 199.
 Martha (Toakey), 154.
 Phoebe = Thornton, 154.
 Robert, 199.
 Thomas, 154.
 Holland, Constanica = Gray, 74.
 Elizabeth (Plantagenot), 74.
 George, 181.
 John, 74.
 Patience (Hollingworth), 184.
 Tristam, 184.
 — = Gray, 139.
 Holleis (or Holleys), George, 9, 196.
 Philippa (Hartop), 9, 196.
 Holliday, Anna (Wincole), 156.
 Leonard, 156.
Hollingworth, 184.
 HOLLINGWORTH, 184.
 Edward, 207.
 Ellina, 184.
 Elizabeth, 184.
 Elizabeth (Berie), 207.
 Emmot (Carre), 184.
 Francisca (Saunderson), 184.
 Isabella (Shawe), 184.
 Patience = Holland, 184.
 Ralph, 184.
 Susan, 184.
 Susanna (Whitby), 184.
 — (Duncalf), 184.
 — (Leversage), 184.
 Holt, Edward, 151.
 Joyce (Purifoy), 37.
 Maria = Smith, 131.
 Thomas, 37.
 Holwell, Richard de, 162.
 Holyoke, Alicia = Gerveis, 71.
 Hoode, Henry, 114.
 Katherin = Noble, 114.
 Maria = Gilbert, 189.
 Thomas, 189.
 Hooker, Dorothea = Chester, 138.
 Thomas, 138.
 Hopkins, George, 185.
 Elizabeth = Salisberie, 185.
 Hopton, Elizabeth = Noell, 3, 114.
 Elizabeth = Perient, 3, 114.
 John, 3, 114.
 Horneblow, Marg^t (Belgrave), 96.
 William, 96.
 Horton, Elizabeth (Cotton), 191.
 Laurence, 191.
 Hotham, Anna = Peck, 147.

Hotham—*continued*.

- John, 147.
 — = Legard, 19.
 Houghton, Agnes = Cave, 127.
 Alice = Cobley, 63.
 Hugh, 63.
 Jana = Smith, 146.
 Maria (Shipward), 82.
 Richard, 82.
 Thobias, 127, 146.
 — = Smith, al's Nevill, 22.
 Howard, Muriell = Gray, 74.
 Thos. [D. of Norfolk], 74.
 Howby, Alice = Sutton, 29.
 Anthony, 29.
 John, 29.
 Mawde (Kirkby), 29.
 Sir Anthonie, 29.
 Sir Walter, 29.
 Sutton al's, 30.
 Howe, Audria = Abney, 152.
 Margareta = Bedell, 195.
 „ = Dixson, 195.
 Robert, 152.
 Howett, Ann = Needham, 100.
 Howland, Sir John, 4.
 Susanna = Noell, 4.
 Huband, Alicia (Walcott), 86.
 Richard, 86.
 Hubarke, Anna = Sherard, 10.
 HUBERT, 38.
 Anne (Brestofte), 38.
 Anne = Sherard, 38.
 Dorothy (Davens), 40.
 Jone (Barnack), 38.
 Mary (Ailesbury), 38.
 Mary = Swinford, 38.
 Mawde = Calveley, 38.
 Nicholas, 40.
 Sir Henry, 38.
 Sir Hugh, 38.
 Sir John, 38.
 — (Corbett), 38.
 Hudeson, Maria (Wincoll), 156.
 Thomas, 156.
 Hudson, Hellen (Brasbridge), 43.
 Huet, Margeria = Vincent, 79.
 Humberston — = Corbett, 177.
Humphrey, 62.
 HUMPHREY, 62.
 Anne, 62.
 Anne = Page, 62.
 Audrey = Harvy, 62.
 Edward, 62.
 Ellina = Ashfeild, 62.
 „ = Stafford, 62.
 Elianor (Vaux), 62.
 Elinor = Babington, 62.
 Elizabeth (—?—), 62.
 Elizabeth (Digby), 40.
 Isabell (Stanley), 62.
 Jane (Linne), 62.
 Jane (Parsells), 62.
 John, 62.
 Margaret (Rous), 62.

HUMPHREY—*continued*.

- Mary (Lane), 62.
 Mary (Merings), 62.
 Mary = Malorye, 62.
 Mawde (Knightley), 62.
 Nathaniell, 62.
 Peter, 62.
 Richard, 62.
 Sir Peter, 62.
 Sir Thomas, 62.
 Susanna (Pilkington), 78.
 Theodosia, 62.
 Thomas, 78.
 William, 62.
 Zacharias, 62.
 Hungerford, Robert Lord, 72.
 „ — = L^d Moelis, 72.
 Maria = Hastings, 72.
 Hunings, Rosa (Cave), 128.
 Hunne, Edward, 95.
 Jocosa (Turner), 95.
 Hunnet, Ellin (Neale), 164.
 Richard, 164.
 Hunston, Anna (Cave), 127.
 Thomas, 127.
 Hunt, Alicia (Bainbrig), 181.
 Dorothea (Skeffington), 8, 112.
 Gartrude = Lany, 196.
 John, 196.
 Thomas, 8, 112, 181.
 William, 109.
 — = Digby, 40.
 Hunter, Elizab. = Peck, 147.
 Hugo, 147.
 Huntington, E. of [Hastings], 73, 74.
 E. of [Holland], 72, 74.
 Hurst, Johanna = Yarde, 91.
 William, 91.
Hursey, 183.
 Hursey, Elizab. (Berkley), 2.
 John, Lord, 2.
 Sir William, 2.
 Hussi, William, 139.
 Hutchin, Anna (Shipward), 82.
 John, 82.
 Hutton, Anthony, 24.
 Doctor, 181.
 Elizab. (Burdet), 24.
 Elizab. (Dalton), 27.
 John, 27.
 Sir William, 24.
 Thomazin = Gee, 181.
 Illingworth, Agnes = Ashley, 14.
 Sir Richard, 14.
 Ingarsby, Jocosa (Skeffington), 112.
 Ingell, John, 67.
 Joyce (Smith), 67.
 Inglebeard, Jana = Hartop, 9, 196.
 William, 9, 196.
Ingleberd, 21.
 Ingleby, Elizab. (Skeffington), 8, 112.
 Richard, 8, 112.
 Inglefeild or Englefeild, Francis, 49.

Inglefeild—*continued*.

- Winifred (Brokesby), 49.
 Ingoldby, Anna = Cave, 125.
 Ralph, 125.
 Ingoldsby, Joyce (Skeffington), 8.
 Isham, Elizabeth = Cave, 128, 133.
 George, 128.
 Gregory, 133.
 Isle, Vis^t de l' [Gray], 74.
 Vis^t de l' [Talbot], 74.
 Isley, Mary = Shirley, 26.
 Thomas, 26.
 Ive, Anna = Corbett, 17.
 George, 17.
 William, 109.
 Ives, Jone (Gee), 181.
 Margaret (Smith), 66.
 Jack, Juditha (Hartop), 197.
 William, 197.
 Jackson, Anna = Bainbrig, 182.
 Elizabeth (Starkie), 175.
 Gracia = Bothom, 165.
 Jacomb, John, 101.
 Maria (Marston), 101.
 Jacques, Elizab. = Banister, 165.
 Robert, 165.
 Jarvis, Ann (Purifoy), 34.
 William, 34.
 Jay, Amicia = Bent, 159.
 Jenkenson, Francisca (Cave), 127.
Jenney, 7.
 Jenney, Edward, 35.
 Susan (Purifoy), 35.
 Jennings — = Kendall, 91.
 Jennings, Marg^t (Bradshaw), 44, 161.
 Jephson, Anna = Dixy, 116.
 Jermin, Elianor (Sherman), 204.
 George, 204.
 Jerveis, Francisca = Chamberlain, 137.
 Jetter [or Jettour], William, 111, 112.
 Elizab. (Skeffington), 111, 112.
 Jobson, Elizabeth = Gee, 181.
 Walter, 181.
 Johnson, Margareta = Robertes, 117.
 Richard, 117.
 Jones, Elizabeth, 130.
 Elizabeth (Thame), 130.
 Francis, 6, 99.
 Francisca = Staesmore, 99.
 John, 133.
 Katherin = Staesmore, 6, 99.
 Maria (Mulsho), 155.
 Richard, 130.
 — = Staesmore, 6.
 Jorton, Jana (Peck), 146.
 Richard, 146.
 Juy, Agnes = Corbett, 48.
 George, 48.

- Jykett, John, 168.
Milicent = Temple, 168.
- Karleton, Herbert de, 129.
Robert de, 129.
- Kebell*, 56.
- KEBELL, 56.
Elizabeth, 56.
Elizabeth = Noble, 114.
Francis, 56.
Henry, 56.
Jane (Griffin), 56.
John, 114.
Margaret, 56.
Milicent (Hasilrigge), 15, 56.
Walter, 15, 56.
— (Sacheverell), 56.
- Keere, Elizab. (Miller), 155.
Thomas, 155.
- Keloway, Ann = L^d Harrington, 59.
Robert, 59.
- Kempe, Ann = Shirley, 27.
Sir Thomas, 27.
- Kendall*, 90.
- KENDALL, 90, 91.
Alicia (Bent), 158.
Bartholmeus, 90.
Catherina, 91.
Christopher, 90.
George, 91, 206.
Henry, 91.
Humphrey, 91.
Jocosa (Danvers), 86.
John, 91.
Katherina = Babington, 206.
Margeria (Sadler), 91.
Margareta, 91.
Margareta (Repington), 42.
Margareta (Swayfeild), 91.
Susanna (Leeson), 91.
Thomas, 158.
William, 86, 90.
— (Armstronge), 91.
— (Jenninges), 91.
— (Shepee), 90.
- Kenning, Elizabeth = Noble, 115.
- Kent, E. of [Gray], 17, 74, 139.
- Kerchewall, Anne (Purifoy), 34.
- Kerkin, George, 28.
Mary (Faunt), 28.
- Kettle, Alice = Thame, 130.
John, 130.
- Kettleby*, 52.
- Kettleby — = Draper, 52.
- Killingham, Thomas, 27.
Elizab. = Laurence, al's Dalton, 27.
- Kime, Francis (Legard), 20.
Gabiell, 20.
- King, Anna (Cave), 120, 127.
Elizab. = Morton, 184.
Phillipa = Needham, 100.
William, 100, 120, 127, 184.
- Kings, George, 73.
Sara (Harrington), 73.
- Kingston, George, 8, 86.
- Kingston—*continued*.
Margaret = Danvers, 86.
Margaret = Farnham, 77.
Mary (Staresmore), 8.
Mary (Skeffington), 112.
- Kinsman*, 69.
- Kirk, Amfillis (Staresmore), 6.
- Kirkby, Anne, 29.
Ciceley, 29,
John, 29.
Mawde = Howby, 29.
Sir William, 29.
- Kirke, Edward, 185.
Elizabeth = Salisberie, 185.
— = Peck, 147.
- Kirketon, Robert, 162.
- Kisse, Jocosa (Vincent), 79.
Richard, 79.
- Knevitt, Johanna (Stafford), 170.
William, 170.
- Knight — (Nevill), 21.
- Knightley, Elizab. (Purifoy), 33.
Margaret = Purifoy, 33.
Mawde = Humphrey, 62.
Mawde = Dannat, 64.
Mawde = de la Hay, 64.
Sir Richard, 62.
- Knolles, Francis, 126.
Henry, 126.
Katherin = Belgrave, 69.
Margareta (Cave), 126.
Richard, 69.
- Knyveton, Ellena = Sturton, 119.
Francis, 119.
Gartruda (Sturton), 119.
William, 119.
- Lacy, 186.
- LACY or LACYE, 75, 166, 186.
Agnes, 166.
Andrew, 166.
Anna (Digby), 75, 186.
Elizabeth, 75, 186.
Elizabeth = Elwood, 75, 186.
" = Frearch, 75, 186.
Elizabeth (Lissay), 75, 186.
Elizabeth (Noell), 166.
Elizabeth (Stanbridg), 166.
Elizabeth (Wilcockes), 166.
Faith, 75, 186.
Gracia, 75, 186.
Henry, 166.
Hugh, 166.
Isabell, 75, 186.
Isabella (Fower or Farrar), 75, 186.
Isabella = Peck, 146.
Jana, 166.
Johanna (Muster), 75, 186.
Johannes, 75, 146, 186.
Leonard, 75, 186.
Margaret (Roskin), 75, 186.
Maria, 75, 166, 186.
Mathew, 75, 186.
Modwen, 75, 186.
Richard, 75, 186.
- LACY—*continued*.
Seth, 75, 186.
Thomas, 75, 186.
William, 75, 166.
- Laddes, Agnes = Ashton, 198.
- Lambe, Anna = Needham, 100.
Robert, 92.
Sara (Whiting), 92.
- Lampton, Constance (Dalton), 27.
- Lancaster, E. of [Plantagenet], 169.
Hugo, 87.
Martha = Warde, 83, 87.
- Lane, Anna = Lascelles, 155.
Bridget (Griffin), 16.
Dorothea (Ashby), 132.
Elizabeth = Villers, 31.
John, 31, 155.
Mary = Humphrey, 62.
Parr, 132.
Sir William, 62.
William, 16.
— (Vincent), 51, 81.
- Laneham*, 21.
- Langford, Sir Raphe, 21.
- Langham*, 12.
- Langham, Anna = Everard, 175.
Anne = Hardwick, 12.
Anne = Markham, 12.
Edward, 12.
Elizabeth = Apleby, 11, 12.
George, 12, 206.
Jana (Babington), 206.
Reignold, 12.
Robert, 11, 12.
Thomas, 12.
— (Purifoy), 37.
- Langley, Thomas, 167.
Katherin = Temple, 167.
- Lany*, 196.
- LANY, 196.
Anna = Cave, 127.
Anna = ?, 196.
Aslake, 196.
Bassebon, 196.
Benjamin, 196.
Faith = Sherman, 203.
Gartrude (Hunt), 196.
James, 196.
John, 196, 203.
Katherina (Yaxley), 196.
Maria (Pooly), 196.
Thomas, 196.
— (Aslake), 196.
- Lascelles*, 155.
- LASCELLES, 155.
Anna (Lane), 155.
Anna (Thornehill), 155.
Brian, 155.
Elizabeth, 155.
Elizabeth (Marbury), 155.
George, 155.
Henry, 155.
Hercules, 155.
Isabella (Montague), 155.
John, 155.
Maria = Sherman, 155, 204.
Samuell, 155.
Laser, Henry, 107.

Laser—*continued*.

- Margaret = Basset, 107.
Lathberye, 51.
 Lathberye — = Chamber, 51.
 Latham, Elianora = Everard, 142.
 William, 142, 162.
 — = Everard, 175.
 Latham, Grisell = Aston, 85.
 Grisell = Gore, 85.
 Latton, William de, 162.
 Laughton, Robert, 77.
 Maria = Farnham, 77.
 — = Hardwick, 42.
 Lavender, Marg^t (Salsberie), 184.
 Thomas, 184.
 Lawde, Lucia (Webbe), 182.
 William, 182.
 Lawe, Anna = Bainbrig, 182.
 Maria (Bainbrig), 182.
 John, 182.
 William, 182.
 Lawley — (Bingley), 5.
 Lawn, Dorothea = Robertes, 118.
Lawrence, 27.
 LAWRENCE, 27, 102.
 Al's Dalton [*see* DALTON], 27.
 Anna, 102.
 Anna = Chetwood, 102.
 Edward, 102.
 Ellina (Denham), 102.
 Elizabeth, 102.
 Elizabeth (Cranwell), 102.
 Elizabeth = Crispe, 102.
 Elizabeth (Litherland), 102.
 Elizabeth (Wright), 102.
 Isabella (Baroden), 102.
 Isabella (Hayes), 102.
 Jana (Parsons), 102.
 John, 27, 102.
 Katherin (Dalton), 27.
 Maria, 102.
 Maria = Sarson, 102.
 Rebecca, 102.
 Robert, 102.
 Sara, 102.
 Sara = Barnby, 102.
 Thomas, 102.
 William, 102, 162
 Laynham, Robert, 131, 145.
 Millicent = Carrington, 131, 145.
 Leadock, Anna (Cotton), 191.
 Joseph, 191.
 Leake, Anna = Bassett, 107.
 Ledes, Cicely (Shirley), 26.
 John, 26.
 Lee, Elizabeth (Shirley), 26.
 John, 26.
 — = Babington, 206.
 Leech, Alice (Brooke), 65.
 Elianora = Swynfen, 134.
 Raph, 65.
 Lecche, Anne = Sacheverell, 45.
 Roger, 45.
 Leedes, Susanna = Kendall, 91.
 Susanna = Savill, 91, 93.

Leedes—*continued*.

- Thomas, 93.
 — = Swinfen, 134.
Legard, 19.
 LEGARD, 19.
 Agnes = Willes, 19.
 Anne (Gee), 181.
 Beatrix = Replingham, 19.
 Christopher, 20.
 Constance (Routhe), 19.
 Constance = ? , 19.
 Elizabeth, 20.
 Elizabeth = Goodknappe, 19.
 Elizabeth = Portington, 19.
 Elizabeth (Whetworth), 19.
 Ellin, 19.
 Ellen = Pilate, 19.
 Ellin (Cliffe), 19.
 Ellin = Ufflett, 19.
 Frances, 20.
 Francis = Kime, 20.
 Isabell (Hilliard), 19.
 Isabell (Byrond), 20.
 Jane = Skepper, 20.
 Jane = Tounley, 20.
 Joane = Cartwright, 19.
 Joane (Haldenby), 19.
 John, 19, 20.
 Margaret (Constable), 19.
 Margaret = Frost, 19.
 Margaret (Moynes), 19.
 Peter, 19.
 Ralphe, 19, 20.
 Robert, 19, 20.
 Richard, 19, 20.
 Roger, 19.
 Thomas, 19.
 William, 19.
 — (Blacket), 19.
 — (Copendall), 19.
 — (Hotham), 19.
 — (Legards), 19.
 — (Rison), 19.
 Legards, Thomas, 19.
 — = Legard, 19.
Leicester, 108.
 Leicester, E. of [Montford], 188.
 Leife, Gracia = Strelley, 194.
 John, 194.
Leigh, 173.
 LEIGH, 173, 174.
 Anna, 174.
 Bartholomew, 174.
 Bersheba (Brookesby), 174.
 Elizabeth, 174.
 Elizabeth = Harecourt, 39, 166.
 Elizabeth (Gregorie), 174.
 Gilbert, 174.
 Henry, 39, 166.
 Isabella (Shipward), 82.
 James, 174.
 John, 174.
 Margeria, 174.
 Margeria (Bishop), 174.
 Maria, 174.
 Martin, 174.
 Phillip, 174.
 Robert, 82, 174.
 William, 174.

LEIGH—*continued*.

- = Beaumont, 170.
 Lenton, John, 64.
 Elizab. = Dannet, 64.
 Leois, Elizab. = Beaumont, 171.
 Le-Strang, Guido, 113.
 Margaret = Noel, 113.
 Leventhorp, William, 170.
 — = Beaumont, 170.
 Levesey, Elizab. (Berkley), 3.
 Robert, 3.
 Leveson, James, 111.
 Johanna = Foulke, 111.
 Johanna = Gifford, 111.
 Johanna = Skeffington, 111.
 Levins, Anna (Marston), 101.
 Lewes, Jocosa (Curson), 11.
 Thomas, 11.
 Lewis — = Beaumont, 61.
 Lichfield, Agneta (Cooke), 108.
 John, 108.
 Roger, 133.
 Thomas, 133.
 William de, 134.
 Lidiard, Clemence = Eyre, 35.
 Clemence = Purifoy, 35.
 Lightfoote, Charitie = Dawes, 98.
 James, 98.
 Lincoln, E. of [Brandon], 73.
 Lincoln, Anna (Power), 106.
 Anna = Willoughby, 106.
 Peter, 106.
 Lindsey, Earl of, 4.
 Margareta = Plumbe, 121.
 Linfield, Elizab. (Cotes), 94.
 Thomas, 94.
 Linne, Jane = Humphrey, 62.
 Thomas, 62.
 L'Isle, Talbot, Viscount de, 74.
 Gray, Viscount de, 74.
 Lisle, Margaret Cave, 120, 126.
 Thomas, 120, 126.
Lisley, 7.
 Lissey, Elizab. = Lacy, 75, 186.
 Litherland, Elizab. = Lawrence, 102.
 John, 102.
 Littleton, Sir Edward, 42.
 Mary (Fisher), 42.
 Liverseege — = Hollingworth, 184.
 Lloyd, John, 121.
 Margareta (Plumbe), 121.
 Lockwood — (Sherman), 203.
 Lole — = Beresford, 178.
 Longe, Elizab. = Cradock, 149.
 Longford, Richard, 73.
 Matilda = Hastings, 73.
 Matilda = Vernon, 73.
 Matilda = Roper, 73.
 Longuillers, John, 21.
 Margareta = Nevill, 21.
 Loudham, Will. de, 162.
 Lounde, Sir Alexander, 125.

- Lounde—*continued*.
 Maria (Cave), 125.
 — = Sheffield, 125.
- Louth, John, 147.
 Juditha (Peck), 147.
 — = Babington, 206.
- Lovell, Galfridus, 170.
 Margaret (—?—), 70.
 Nicholas, 70.
 Viscount, 170.
 — (Beaumont), 170.
- Lovett, Anna = Earle, 4.
 Anna = Noell, 4.
 Elizab. = Cave, 126.
 Jane = Shirley, 26.
 Jocosa = Temple, 167.
 Pinchpool, 152.
 Sir Robert, 4.
 Susanna = Cowper, 152.
 Thomas, 26, 126.
- Lowe, Fifeild al's, 52.
 Goditha (Bent), 159.
 Hugo, 159.
- Lowes, Isabell (Smith), 66.
- Lowther, Sir Christopher, 24.
- Lucy, Joane = Brasbridge, 43.
 Thomas, 43.
- Ludford, Anne (Skeffington), 8, 112.
 Thomas, 8, 112.
- Ludlow, Katherin = Abney, 154.
 William, 154.
- Luffe, Agneta = Cowper, 154.
- Lumley, Elizab. = Farrent, 202.
 Martha = Hall, 204.
- Luson, Elizabeth = Yarde, 91.
 John, 91.
- Luther, Anna = Rudiard, 202.
 Anthony, 202.
- Mablethorpe, Ann = Nevill, 21.
- Mackworth — (Hall), 46.
- Madock, Jana = Everard, 142.
 Susanna = Wincoll, 156.
- Madox — = Everard, 13.
- Makepeace, Abell, 176.
 Lucia = Trimmell, 176.
- Maldacum, Matilda = Cave, 125.
 Peter, 125.
- Malin, Hellenia (Gregorie), 188.
 John, 188.
- Mallorye*, 12, 58.
- Mallorye, Mallory or Malory.
 Alice (Driby), 58.
 Beatrix = Baghot, 59.
 Dorothea = Cave, 126.
 Elizabeth, 59.
 Elizabeth = Bowier, 134.
 Elizabeth = Fenton, 58.
 John, 58, 134.
 Margery = Motton, 59.
 Margery (Turvill), 55.
 Mary (Humphrey), 62.
 Nicholas, 126.
 Roger, 58.
 Sir Antikell, 58.
- Mallorye, Mallory or Malory—*continued*.
 Sir Thomas, 58, 59.
 Thomas, 58.
 William, 59.
 — = Staresmore, 5.
- Mallowe — = Chambers, 51.
- Malovell*, 7.
- Malson, Anna (Wilcocks), 136.
 Christopher, 136.
- Maneringe, Marg^t. (Brooke), 65.
 Roger, 65.
- Manfeild, Edward, 131.
 Maria (Smith), 131.
- Manley, Robert, 187.
 Susanna (Nicolls), 187.
- Manning, John, 141.
 Margaret = Bale, 141.
- Mannors, Francis [E. of Rutland], 30.
 Catherin = L^d Donlower, 30.
 — = Villers, 30.
- Mansfeild, Katherin = Peper, 103.
 Richard, 103.
- Manwaring, Charles, 65.
 Margery = Brooke, 65.
- Marbery, Edward, 133.
 Elizabeth (Cave), 133.
 Margareta (Cave), 133.
 Thomas, 133.
- Marbury, Elizab. = Lascellos, 155.
 William, 20.
 — = Cheselton, 20.
- Markham, Anne (Langham), 12.
 Anne = Smith, 132.
 Thomas, 38, 132.
 — = Woodford, 38.
- Marmaduke, Eliz. = Shirley, 26.
- Marmion, Albreda = Camvile, 23.
 Galfridus, 23.
 — = Pilkington, 78 [note].
 — = Haselwood, 78 [note].
- Marriott, Anthony, 202.
 Martha = Farrent, 202.
- Marrow, William, 60.
 — = Ashby, 60.
- Marsh, Agneta = Bent, 158.
 John, 158.
 Maria (Starkie), 175.
 Richard, 175.
- MARSHALL, 103.
 Anna (Cave), 68, 126.
 Christian (Staresmore), 6.
 Francis, 103.
 Francisca = Gore, 85.
 George, 103.
 Gracia (Elkington), 85.
 Isabella (Milborne), 103.
 James, 103.
 John, 68, 103.
 Katherina (Champion), 103.
 Katherin (Nevill), 21.
 Margareta (Milborne), 103.
 Ralph, 21.
 Roland, 103.
 Sara, 103.
- MARSHALL—*continued*.
 Sibilla, 103.
 Sibilla (Claxton), 103.
 Thomas, 85, 103.
 William, 103.
 — (Smith), 103.
- Marson, Francisca = Gerveis, 71.
 Richard, 71.
- Marstone*, 101.
- MARSTON or MARSTONE, 101, 102.
 Alicia (Payne), 101.
 Anna, 101.
 Anna (Hawes), 101.
 Anna (Marston), 101.
 Anna = Levins, 101.
 Benjamin, 101.
 Catherina, 101.
 Edward, 101.
 Elizabeth, 101.
 Elizabeth = Pratt, 101.
 Elizabeth (Savill), 101.
 Ellina = Collins, 101.
 Everard, 101.
 Gilbert, 100.
 Gracia = Moore, 101.
 Henry, 101.
 Jane, 101.
 Johanna, 102.
 Johanna (Bowman), 102.
 John, 101, 102.
 Katherina, 102.
 Katherina = Dillingham, 101.
 Lawrence, 101.
 Margareta (Hawes), 101.
 Margeria = Colman, 101.
 Maria = Jacomb, 101.
 Maria (Pickering), 101.
 Maria (Turvill), 101.
 Morell, 101.
 Thomas, 101.
 Tobias, 101, 102.
 William, 101, 102.
 — (Barret), 101.
 — (Goderich), 101.
 — (Payne), 101.
- Martin, Alicia = Baghot, 150.
 Anne = Turvill, 55.
 John, 55, 150.
 Nicholas, 6.
 Ursula (Staresmore), 6.
- Martival*, 129.
- MARTIVAL, 129.
 Agneta (—?—), 129.
 Anketinus de, 129.
 Fulco de, 129.
 Isabella (—?—), 129.
 Nicholas de, 129.
 Ralph de, 129.
 Robert de, 129.
 Thomas de, 129.
 William de, 129.
- Martivaux, William de, 129.
- Martivall, William de, 129.
- Martivast, William de, 129.
- Marvin, Eliz. = Cave, 126.
 Margaret = Everard, 142.
- Marward, Thomas, 169.
 Phillipa = Beaumont, 169.

- Mascall, Ellen = Overton, 193.
 Mason, Christopher, 81.
 Briget = Hartop, 9, 197.
 Elizabeth (Vincent), 81.
 William, 9, 197.
 Masterson, Maria = Turner, 95.
 Mathew, Barbara = Pilkington, 78.
 Edward, 78.
 Maxwell, Lord, 171.
 — = Beaumont, 171.
May, 180.
 MAYE or MAY, 180.
 Alicia = Wright, 180.
 Anna (Hodgis), 154.
 Dorothea = Twine, 180.
 Gracia (Mortimer), 180.
 Jeffery, 180.
 Joanna (Denston), 180.
 John, 180.
 Katheria, 180.
 Margareta, 180.
 Margareta (Dalley), 180.
 Marya, 180.
 Presilla (Stiles), 180.
 Richard, 180.
 Steven, 154.
 Thomas, 180.
 William, 180.
 Maynard, Isabell (Smith), 66.
Meade, 151.
 MEADE, 151.
 Agnetta = Gilbert, 151.
 Anna (Croftes), 141, 151.
 Elizabeth, 151.
 Henry, 141, 151.
 Hugo, 151.
 Jacob, 151.
 James, 151, 158.
 Jocosa = Weston, 151.
 John, 151.
 Margaret, 151.
 Maria, 151.
 Maria = Bent, 151, 158.
 Maria (Rodes), 151.
 William, 151.
 — (Wedgwood), 151.
 Medbourne, Raphe de, 129.
 Medley, George, 64.
 Margaret (Wotton), 74.
 Mary (Dannet), 64.
 William, 74.
 Meeres, Anthony, 41.
 Katherin (Digby), 41.
 Meidwell — = Staesmore, 6.
 Menell, Thomas, 133.
 Mercy, Anna (Everard), 142.
 Thomas, 142.
 Meredith, Elizab. (Chippingdale), 157.
 Richard, 157.
 Merihurst, Audry = Hill, 149.
 William, 149.
 Mering, Elizab. (Nevill), 21.
 William, 21.
 Meringe, Elizabeth (Vincent), 79.
 John, 79.
 Meringe—*continued*.
 Mary = Humphrie, 62.
 William, 62.
 Meverell, Elizabeth = Wase, 200.
 George, 200.
 Jane = Brooke, 65.
 Michell, Elizab. = Brookesby, 201.
 Elizab. (Salisberie), 185.
 Elizabeth (Shirley), 26.
 Febe = Chester, 138.
 John, 26, 138.
 Thomas, 201.
 William, 185.
 Michelson, Thos., 162.
 Middleton, Alicia = Peck, 147.
 Elizabeth (Griffith), 205.
 Middleham, Lady of, 21.
 Mary = Nevill, 21.
 Midleton, Elizabeth (Vincent), 79.
 John, 79.
 Milbourne, Isabella = Marshall, 103.
 Margaret = Marshall, 103.
 Rowland, 103.
 Miles, Alicia (Bent), 159.
 Emma = Brokesby, 49, 173.
 Francisca = Pilkington, 78.
 Richard, 159.
 Milgate, Isabella = Baynbridge, 181.
 William, 181.
 Mill, Jane = Brasbridge, 43.
 Thomas, 43.
 Miller, Elizab. = Keere, 155.
 Elizab. = Mulsho, 155.
 Milles, Katherin (Burton), 57.
 Mingay, Winifred (Cooke), 46.
 Minors, Dorothy = Ashby, 60.
 Thomas, 60.
 Mitford, Bartram Lord of, 21.
 Mitton, John, 194.
 Margaret = Vough, 194.
 — = Beaumont, 170.
 — (Dester), 194.
 Moelis, Lord [Hungerford], 72.
 Mogg, Anna (Staesmore), 6.
 Moleneux, Dorothea = Alsop, 105.
Molins, 48.
 Molins, Elizabeth (Montacute), 48.
 Jean (Montague), 124.
 Henry, 48.
 John, 48.
 Lord [Hungerford], 72.
 William, 48.
 Mollins, Jean, 124.
 Jean (Montague), 124.
 Monke, Maria (Skeffington), 112.
 Robert, 112.
 Montacute, Elizabeth = Molins, 48.
 Elizabeth = Molins, 48.
 Emmala = de Porte, 48.
 William, 48.
 Montague [*crest of*], 124.
 Agnes (Atmore), 124.
 Anna (Wincoll), 156.
 Edward, 155.
 Elianora = Bevin, 124.
 Emma = Duport, 124.
 Guillaume, 124.
 Henry, 156.
 Isabella = Lascelles, 155.
 Jean = Mollins, 124.
 Jean, 124.
 Katherin = Carrington, 131, 145.
 Lord [Poole], 72.
 Robert, 124.
 Viscount [Browne], 72.
 William, 131, 145.
 — (Peverell), 124.
 Montford, Simon de [E. of Leicester], 188.
Montfort, 64.
 Montgomery, Anne (Smith), 66.
 Bridget = Cheselton, 20.
 Elizabeth (Grimsby), 50.
 John, 50.
 Sherrington, 66.
 Moore al's Smith, Thos., 101.
 Anna = Sherard, 10.
 Edward, 164.
 Gracia (Marston), 101.
 Gregory, 10.
 Margaret = Allen, 109.
 Maria (Pochin), 106.
 Mary = Neale, 164.
 Robert, 106.
 More, Alice = Caldwell, 192.
 Catherine (Cane), 125.
 John, 125.
 Morgan, Mildred = Pilkington, 78.
 Walter, 78.
 Morris, George, 134.
 Katherin (Swynfen), 134.
 Mortimer, Gracia = Maye, 180.
 Luke, 180.
Morton, 47, 183.
 MORTON, 183, 184.
 Agnes, 47.
 Alicia (Borage), 183.
 Anna = Bent, 159.
 Anna (Bowyer), 184.
 Anna (Chettle), 184.
 Anna = Gladwyn, 184.
 Cecilye, 47.
 Dorothy = Caldwell, 192.
 Edward, 184.
 Elizabeth (King), 184.
 Francis = Slimun, 184.
 Francisca (Yate), 184.
 Hellen, 47.
 Hellena (Roper), 131.
 Jana = Smith, 146.
 John, 47, 131, 146, 183, 184.
 John [Archbp. of Cant.], 47.

MORTON—*continued.*

- John [Archbp. of York], 131.
 Juditha (Chedlow), 184.
 Margareta (Peck), 146.
 Margareta (Woodford), 146.
 Maria (Allen), 184.
 Maria = Smith, 146.
 Nicholas, 184.
 Robert, 183, 184.
 Thomas, 47, 131, 183.
 William, 47, 109, 159, 183, 184, 192.
 Mottes, Robert, 179.
 Ursula = Farmer, 179.
Motton, 12, 50, 58.
 MOTON or MOTTON, 58, 59.
 Agnes, 58.
 Alaine, 58.
 Alexander, 58.
 Alice (Basset), 58.
 Anne, 59.
 Anne = Grimsby, 12, 50, 59, 80.
 Edward, 59.
 Elizabeth (Mulso), 54, 59.
 Elizabeth = Harington, 59.
 Elizabeth = Poole, 59.
 Havise = Beaumont, 59.
 Henry, 58.
 John, 59.
 Julian (—?), 58.
 Katherin, 59.
 Margaret (Bugge), 59.
 Margery (Malory), 59.
 Margery = Purifoy, 59.
 Philippa (Willoughby), 59.
 Raphe, 58.
 Reignold, 50, 59, 80.
 Robert, 58, 170.
 Sara (—?), 58.
 Sir Robert, 54, 58, 59.
 Sir William, 58.
 Symon, 58.
 Thomazin = Beaumont, 59.
 William, 58.
 — = Beaumont, 170.
 — (Harecourt), 59.
 Moulton, Sir Thomas, 28.
 Mountacute [E. of Lindsey], 4.
 Elizabeth = Noell, 4.
Mountney, 179.
 MOUNTNEY, 179.
 Anne (Whithill), 45.
 Dorothea = Hemsley, 179.
 Francisca, 179.
 George, 179.
 Jocosa (Whithill), 179.
 Katherina, 179.
 Margareta, 179.
 Margareta (Taylor), 179.
 Stephen, 179.
 Thomas, 179.
 William, 179.
 Mowlesley, Marg^t. (Vincent), 79.
 William, 79.
 Moyne, Alexander, 9, 196.
 John, 19.
 Margaret = Legard, 19.

Moyne—*continued.*

- = Faunt, 28.
 — = Hartop, 9, 196.
 Muckeslow, Francis, 185.
 Elizabeth (Salisberie), 185.
 MULSHO, 155.
 Anna, 155.
 Anna (Danvers), 87, 155.
 Anna = Bailey, 155.
 Benedict, 155.
 Edward, 155.
 Elizabeth = Bouge, 54, 59.
 " = Motton, 54, 59.
 Elizabeth (Miller), 155.
 Elizabetha, 155.
 Francis, 87, 155.
 George, 155.
 Johanna (Abraham), 155.
 Margerie = Grigge, 155.
 Maria (Borowe), 155.
 Maria = Coningham, 155.
 Maria = Jones, 158.
 Richard, 155.
 Sir Edward, 55.
 — = Digby, 49.
 Muncke, Mary (Skeffington), 8.
 Thomas, 8.
 William, 8.
 Mussen, Anna (Whitaph), 98.
 Margeria (Peck), 147.
 William, 98, 147.
 Muster, Joanna = Lacy, 75, 186.
 Mutton, Alicia (Basset), 80.
 Anna (Bugges), 80.
 Elizabeth = Poole, 80.
 Reginald, 80.
 Robert, 80.
 William, 59, 80.
 NEALE, 163, 164.
 Agneta (Savag), 164.
 Anna = Stokes, 164.
 Elizabeth (Brabason), 164.
 Elizabeth (Rouse), 164.
 Elizabeth (Smith), 164.
 Ellin = Hunnct, 164.
 Ellina = Fowler, 164.
 Francis, 164.
 Isabella (Sprig), 164.
 Jana = Stevens, 164.
 Joanna = Prate, 163.
 John, 163, 164.
 Judith, 164.
 Maria (Moore), 164.
 Richard, 15, 163, 164.
 Theodora = Stokes, 164.
 Thomas, 164.
 William, 163.
 De Poultney, Adam, 70.
 Nedham, Prudencia (Peck), 147.
 William, 147.
Needham, 100.
 NEEDHAM, 100.
 Ambrose, 100.
 Anne (Howett), 100.
 Anne (Lambe), 100.
 Anne (Gamble), 100.
 Anna (Shawe), 100.
 Anna, 100.
 Anthony, 100.

NEEDHAM—*continued.*

- Briget, 100.
 Caleb, 100.
 Clement, 100.
 Constanca (—?), 100.
 Dorothea = Watson, 100.
 Edward, 100.
 Elizabeth = Ferne, 146.
 " = Smith, 146.
 Etheldrida = Guest, 100.
 Francis, 100.
 Grace = Decon, 100.
 Gracia, 100.
 Isabella, 100.
 Isabella (Cave), 100.
 Ismaell, 100.
 John, 100.
 Katherina, 100.
 Margery (Ashby), 100.
 Maria, 100.
 Mellicent, 100.
 Philippa (King), 100.
 Richard, 100.
 Robert, 100.
 Susanna, 100.
 Thomas, 100.
 William, 100.
 — (Hobson), 100.
 — (Parker), 100.
 — (Wilcock), 100.
 Neel, John, 162.
Neele, 45.
 NEELE, 46, 46.
 Alice (Sutton), 46.
 Alice (—?), 46.
 Alice = ?, 46.
 Anthony, 46.
 Christopher, 46.
 Edward, 46.
 Elizabeth = Elliott, 46.
 Elizabeth (Slorrey), 46.
 Francis, 46.
 George, 46.
 John, 46, 162.
 Jone = Hall, 46.
 Margaret, 46.
 Margaret (Bateman), 46.
 Mary = Digby, 46.
 " = Erdeswicke, 46.
 Richard, 45, 46, 163.
 Robert, 46.
 William, 46, 162, 163.
 Winifrede (Cooke), 46.
 — = Hall, 46.
 Nethercote, John, 92.
 Martha (Whiting), 92.
 Nethermill — = Brasbridg, 43.
Nevill, 21.
 NEVIL, NEVILLE, or NEVILL, 21, 22.
 Alice (Audley), 21.
 Alice = Clifton, 21.
 " = Thurland, 21.
 Amphelicia (Rolleston), 21.
 Anne (Maplethorp), 21.
 Cicilia (Blanchminster), 21.
 Clare = Nevill, 22.
 Edward, 75.
 Elizabeth = Gray, 75.
 " = Bingley, 75.
 " = Elizabeth (Babington), 21.

NEVIL, NEVILLE, OR NEVILL.—
continued.

Elizabeth = Mering, 21.
Euphemia (Clavering), 21.
Galfred, 21.
George [L^d Abergavenny],
72.
Isabella (Bartram), 21.
Jana = Poole, 72.
John, 21.
Jone (—?—), 22.
Jone = Constable, 22.
Katherin = L^d Bonville and
Harrington, 72.
" = L^d Hastings, 72.
Katherin = Marshall, 21.
Katherine (Palmer), 21.
Katherine (Foliamb), 22.
Margaret (Longuillers), 21.
Mary (Middleham), 21.
Mary = Pate, 19.
Mary = Disney, 21.
Mary = Harvy, 22, 146.
" = Smith, 22, 131, 146.
Matilda (Percy), 21.
Maud (Gray), 21.
Radulphus, 21.
Ralphe, 22.
Ranulphus, 21.
Richard [E. of Salisbury],
72.
Robert, 21.
Sir Alexander, 21.
Sir Andrew, 21.
Sir Ralphe, 21.
Sir Robert, 21.
Sir Thomas, 21, 22.
Sir William, 21, 22.
Thomas, 22, 131, 146, 180.
Ursula = Gee, 180.
William, 21, 22.
— (Fencotts), 21.
— (Griffin), 22.
— (Knight), 21.
— (Langford), 21.
— (Lucy), 22.
— = Stukeley, 21.
— (Ward), 22.
Nevill, Smith *alias*, 22.
Alice (Duccombe), 22.
Clement, 22.
Henry, 22.
Nevill, 22.
Sir Thomas, 22.
Thomas, 22.
William, 22.
Newdigate, John, 126.
Martha (Cave), 126.
Newport, William, 134.
Newton, Edward, 161.
Maria (Bretton), 161.
Nicholson, Anne (Digby), 41.
Anthony, 41.
Nicolls, 187.
NICOLLS.—
Anna, 187.
Anna (Haselrig), 16, 187.
Anna (Pell), 187.
Anna (Seamour), 187.
Augustine, 187.
Elizabetha, 187.
Francis, 187.

NICOLLS—*continued.*

Jane, 187.
Jocosa (Gifford), 187.
Lodovicus, 187.
Margeria = Purefoy, 187.
Maria (Bagshaw), 187.
Maria (Heminges), 187.
Maria, 187.
Presilla (Caldwall), 192.
Susanna = Manley, 192.
Thomas, 16, 187.
William, 187.
Nigell, John, 162, 163.
Richard, 162, 163.
Noble, 114.
NOBLE, 114, 115.
Agneta = Wattes, 115.
Catherina, 115.
Elizabeth (Kebell), 114.
Elizabeth (Kenning), 115.
Elizabeth = Sacheverell,
115.
Francis, 115.
Francisca (Herick), 115.
George, 114, 115.
Joseph, 115.
Katherina (Hooede), 114.
Margareta, 115.
Margareta = Wattes, 115.
Maria = Wattes, 115.
Robert, 115.
Thomas, 114, 115.
William, 114, 115.
— (Webster), 114.
Noel, 3, 113.
NOEL or NOELL, 3, 4, 113,
114.
Alexander, 4.
Alicia (—?—), 113.
Alicia = Harcourt, 113.
Alicia (Wiverston), 113.
Andreas, 3, 114.
Andrew, 4, 28, 114.
Anna (Fowler), 3, 114, 140.
Anne (Feilding), 4.
Ann (Lovett), 4.
Anne, 4, 114.
Arthur, 4, 114.
Baptist, 4.
Cicilia (—?—), 113.
Charles, 4.
Dorothea (Coniers), 3, 114.
Edward, 4, 114.
Eliador, 114.
Elizabeth (Hopton), 3, 114.
Elizabeth = Harper, 4.
Elizabeth = Chaworth, 4.
Elizabeth (Mountacute), 4.
Elizabeth = Faunt, 28, 114.
Elizabeth (Hix), 114.
Elizabeth = Lacy, 166.
Ellinor, 4.
Francis, 4, 114.
Francisca (Fulwood), 4, 114.
George, 114.
Henry, 3, 4, 114.
Hester, 4.
Hester (Wotton), 4.
Isabell = Chetwood, 113.
Jacobus, 3.
James, 114.
Jana (Dracott), 113.

NOEL or NOELL—*continued.*

Jana (Sonde), 113.
Joan (Acton), 113.
Johanna = Duston, 113.
John, 3, 4, 114, 140.
Julian, 4.
Julian (Hix), 4.
Judith, 114.
Katherin, 4, 114.
Lindsey, 4.
Lucia = L^d Eure, 4.
Mabell (Harrington), 3, 114.
Margareta (Le Strang), 113.
Mary = De la Fontaine,
4.
Mary, 4.
Matilda (Breerton), 113.
Penelopie, 4.
Phillip, 113.
Richard, 113, 114.
Robert, 113, 114.
Sir Andrew, 3.
Sir Edward, 4.
Susanna (Howland), 4.
Theodosia = Cecil, 4.
Thomas, 113.
Verney, 4, 114.
William, 4, 113, 114.
— (Asplane), 114.
— (Palmer), 114.
— (Poole), 114.
Noone, 174.
NOONE, 174.
Francis, 174.
George, 174.
Jana (Wymark), 174.
John, 174.
Katherin (Goodier), 174.
Margareta (Cudden), 174.
Maria = Derby, 174.
Robert, 174.
Thomas, 174.
William, 174.
Norrice, John, 109.
Norris, John, 148.
Maria (Whaley), 149.
North, Anne = Sturton, 119.
Edward, 119.
Northampton, E. of [Compton],
171.
Northumberland, D. of [Dud-
ley], 74.
Norton, Cornelia = Duport,
124.
John, 96.
Prudencia = Belgrave, 96.
— = de Port, 48.
— = Whethill, 45.
Norwich, Anna = Woodford,
38, 47.
Briget (Smith), 66.
Simon, 38, 47.
Norwood, Dorothy (Whethill),
45.
Nowers, 135.
Nowers, Margeria (Buckland),
135.
Margeria = Wilcocks,
135.
Ralph, 135.
Robert, 135.
Nudigate, Henry, 16.

- Nudigate—*continued*.
 Maria (Haselrigg), 16.
- Ockover, Phillip, 57.
- Odingselles, Ellianor (Adcot), 9.
- Odingsells, John, 197.
 Susan (Hartop), 197.
- Oldbeffe*, 7.
- Oldebeffe, Margaret (Skeffington), 7, 110.
 Margaret (English), 7, 110.
 Maude (Cambridg), 7, 110.
 Matilda (Cambridg), 110.
 William, 7, 110.
- Olife, Anna, 200.
 Augustin, 200.
 Elizabetha, 200.
 Elizabetha (Wase), 200.
 Thomas, 200.
- Oliver, Francisca = Chippingdale, 157.
 Margareta = Belgrave, 96.
 Thomas, 96.
- Orme, Dennis, 97.
 Ellina = Wigley, 97.
 — = Bradshaw, 44, 161.
- Ormeston, Anna (Swynfen), 134.
 Thomas, 134.
- Osborne, Edward, 92.
 Elizabeth = Roos, 92.
- Otefeild, Gracia = Bent, 158.
 Thomas, 158.
- Overey, Mary (Skeffington), 8, 112.
 — = Burgh, 8.
- OVERERTON, 193.
 Agneta, 193.
 Alicia, 193.
 Brigetta, 193.
 Dorothea, 193.
 Dorothea = Grigge, 193.
 Dorothea (Harper), 193.
 Edward, 193.
 Elianor (Mascall), 193.
 Ellena, 193.
 John, 193.
 Lucia, 193.
 Richard, 193.
 Thomas, 193.
 William, 193.
- Oxenbridge, Dorothy = Digby, 40.
 Thomas, 40.
- PACE, 63.
 Alice, 63.
 Alice (Reade), 63.
 Elizabeth (Touchbourne), 63.
 John, 63.
 Margaret (Cobley), 63.
 Thomas, 63.
- Page, Thomas, 62.
- Pagenham, Elizab. (Berkley), 3.
 Henry, 3.
 Robert, 3.
 — (Chicheley), 3.
- Paget, Emma (Peper), 103.
 William, 103.
- Paginton, Dorothy (Smith), 66.
 Sir John, 66.
- Palladay, Elizab. = Everard, 142.
Palmer, 21, 39.
- PALMER [ET HARECOURT], 39.
 Alicia = Bainbrig, 190.
 Christian, 39.
 Elizabeth (Purifoy), 33.
 Elizabeth = Purifoy, 39.
 Jane = Harecourt, 39, 166.
 Joan (Brett), 39.
 John, 39.
 Katherin = Nevill, 21.
 Margareta (Brudnell), 143.
 Maria (Belgrave), 96.
 Maria = Pochin, 39, 106.
 Nicholas, 39.
 Robert, 39, 190.
 Thomas, 21.
 William, 33, 39, 96, 106.
 — = Noell, 4.
- Palmes, Francis, 177.
 Margareta (Corbet), 177.
- Paramour, Maria (Beaumont), 61, 171.
 Richard, 61, 171.
- Parkenhall, Robert, 159.
 — = Bent, 159.
- Parker, Elizabeth (Hall), 204.
 Goditha (Cotton), 191.
 Henry [*note*], 1, 70.
 Katherin (Temple), 168.
 Nicholas, 168.
 Thomas, 159, 204.
 William, 191.
 — = Bent, 159.
 — = Needham, 100.
- Parre — = Sherard, 88.
 — = Staresmore, 6, 99.
- Parret, Katherin = Perin, 198.
 Thomas, 198.
- Parrlane, Dorothy (Ashby), 13.
 Parsells, Jane = Humphrey, 62.
 Robert, 62.
- Parsemer — = Cave, 126.
- Parslow, Magdalena = Elkington, 153.
- Parsons, Jana = Laurence, 102.
 Robert, 102.
- Partrich*, 5.
- Partrich — = Staresmore, 5, 99.
- Passon, Margeria = Peck, 147.
- Pate*, 89.
- PATE, 89.
 Anna, 89.
 Anna (Blount), 89.
 Edmond, 89.
 Edward, 89.
 Elizabeth, 89.
 Elizabeth = Starkie, 175.
 Ellena, 89.
 Helena (Saltmarsh), 89.
 Henry, 89.
 Jana (Hidson), 89.
- Pate*—*continued*.
 John, 89, 175.
 Maria (Nevill), 89.
 Rebecca, 89.
 Richard, 89.
 Timothy, 89.
 Thomas, 89.
- Pattinson, Faith = Robertes, 203.
- Pauncefoote*, 170.
 Johanna = Beaumont, 60, 170.
 Thomas, 170.
- Paurbeck, Viscount [Villers], 30.
- Pawcoe*, 69.
- Payne, Alicia = Marston, 101.
 Johanna (Gerveis), 71.
 Thomas, 71, 101.
 William, 101.
 — = Marston, 101.
- Peake, Agnes = Dannet, 64.
- Peche*, 65.
- PECHE, 65.
 Francis, 65.
 Henry, 65.
 John, 65.
 William, 65.
 — (Whitchevell), 65.
- Pechet*, 11.
- Pechet, William, 11.
- Peck*, 146.
- PECK, 146, 147, 148.
 Alicia = Barton, 160.
 Alicia (Middleton), 147.
 Alicia (Bradford), 147.
 Alicia = Turvey, 147.
 Anna, 147.
 Anna (Hotham), 147.
 Anne = Wigbett, 147.
 Anna Maria = Harrison, 148.
 Blanche, 148.
 Dorothea, 147.
 Elizabeth, 147, 148.
 Elizabeth (Hunter), 147.
 Elizabeth = Vavasour, 147.
 „ = Dixon, 148.
 Eustace, 147.
 Francis, 147, 148.
 Hugo, 147.
 Isabella (Lacy), 146.
 Isabella, 147.
 Jana = Jorton, 146.
 Jana (Anne), 147.
 Jasper, 147.
 Joane, 148.
 Johanna (Harrington), 146.
 Johanna, 147.
 John, 146, 147, 148.
 Juditha = Lowth, 147.
 Katherin = Scargill, 146.
 Katherin (Vavasour), 147.
 Margareta, 147.
 Margareta (Haselden), 146.
 Margareta = Marton, 146.
 Margeria (Passon), 147.
 Margeria = Musson, 147.
 Maria (Cave), 128, 147.
 Marie, 148.
 Nicholas, 147.

PECK—*continued.*

- Prudencia = Nedham, 147.
 Phillippa, 148.
 Rebecca = Smith, 147.
 Reginald, 147.
 Richard, 146, 147, 160.
 Simon, 148.
 Stephen, 128, 147, 148.
 Thomas, 146, 147, 148.
 William, 147, 148.
 — (Kirke), 147.
 — = Peck, 148.
 — (Sevens), 147.
 Peirpoint, Anne = Beaumont,
 60, 172.
 George, 5, 172.
 Sir George, 60.
 — = Walshall, 5.
 Peke, Margaret = Roos, 92.
 William, 92.
 Pekulton, Matilda = Grigo-
 rie, 187.
 Pell, Anne = Nicolls, 187.
 Jocosa (Ashby), 13, 132.
 John, 187.
 William, 132.
 — = Foxston, 36.
 — = Purifoy, 36.
 Pemleberie, Elizab. = God-
 dard, 190.
 Pembroke, E. of [Herbert],
 139.
 Penbery, Elizabeth (Ashby),
 14.
 Penint, Elizabeth (Hopton),
 3.
 John, 3.
Peper, 103.
 PEPER, 103.
 Emma = Paget, 103.
 Isabella (Bugg), 103.
 Jana = Worthington, 103.
 John, 103.
 Katherina (Mansfeld), 103.
 Maria (Shefeld), 103.
 Richard, 103.
 Robert, 103.
 Thomas, 103.
 William, 103.
 — = Smith, 67.
 Percy, John [D. of Northum-
 berland], 73.
 Henry [E. of Northumber-
 land], 139.
 Henry, Lord, 21.
 Katherin = Grey, 139.
 Katherin (Hastings), 73.
 Matilda = Nevill, 21.
 Perefoy — = Staresmore, 5.
 Perient, Eliz. (Hopton), 114.
 John, 114.
Pern, 198.
 PERIN, 198.
 Anna (Potter), 198.
 Elizabeth, 198.
 Elizabeth (Scrimshaw), 198.
 Gilbert, 198.
 Katherin, 198.
 Katherin (Parret), 198.
 Maria, 198.
 Sara, 198.
 Thomas, 198.

- Perkins, Anna (Roberts), 118.
 Margareta (Bent), 159.
 Richard, 159.
 Thomas, 118.
 — = Purifoy, 39.
 Pernich, Edmond, 63.
 Maude (Cave), 63.
 Sir Roger, 63.
 William, 63.
 Perrin, Anna = Purifoy, 34.
 Persall, Richard, 88.
 Elizab. = Sherrard, 88.
 l'erson, Rosa = Baghot, 150.
 Pert, Amicia (Baghot), 150.
 Daniel, 150.
 Peter — = Gregorie, 88.
 Peterborough, Bp. of [Dove],
 106.
 Peto — = Digby, 199.
 Pettie, Johanna = Bale, 141.
 Peverell — = Montague, 124.
 Phetiplace, Anne = Purifoy,
 33, 35.
 Richard, 35.
 Thomas, 33.
 Philipps, Elizabeth = Cowper,
 152.
 Gawinus, 78.
 Gertrude (Pilkington), 78.
 Thomas, 152.
 Pichley, Margery = Purifoy,
 34.
 Nicholas, 34.
 Pickering, Gilbert, 101.
 Joan (Billne), 30.
 Maria = Marston, 101.
 Sir William, 30.
 — = Berie, 207.
 Pickwell, John, 64.
 Mawde = Dannet, 64.
 Pigeon, Anna = Savill, 93.
 Simon, 93.
 Pilate, Ellin (Legard), 19.
 Thomas, 19.
 PILKINGTON, 78.
 Anna (Eyton), 183.
 Barbara (Mathews), 78.
 Dorothea (Powtrel), 78.
 Edmond, 78.
 Edmund, 78.
 Edward, 78.
 Elizabeth, 78.
 Francisca (Miles), 78.
 George, 78.
 Gertruda = Phillips, 78.
 Henry, 183.
 Hugo, 78.
 Jeronimus, 78.
 Katherina, 78.
 Katherina (Basset), 78.
 Lekus, 78.
 Margeri (Babington), 78.
 Maria = Armestronge, 78.
 Maria (Andrea), 78.
 Maria (Gibson), 78.
 Mildreda (Morgan), 78.
 Robert, 78, 183.
 Samuell, 78.
 Susanna = Humphrey, 78.
 Thomas, 78, 183.
 William, 183.
 — (Marmion) [*note*], 78.

PILKINGTON—*continued.*

- (Willoughby), 78.
 Pinchbeck, Anne (Billne), 30.
 Sir Thomas, 30.
 Plant, Emma = Wigley, 97.
 Plantagenet, Alianora = Bello-
 monte, 169.
 Arthur, 74.
 Elizabeth (Dudley), 74.
 Elizabeth = Holland, 74.
 George [D. of Clarence],
 72.
 Henry [E. of Lancaster],
 169.
 Juliana [*illegitimate*], 64.
 Plesington, Isabell = Fran-
 cis, 49.
 Isabell = Sapcott, 49.
 Jane = Flower, 49.
 John, 49.
 Margaret = Strelley, 49.
 Sir Humphrey, 49.
 Sir Robert, 49.
 William [*potius* John Fran-
 cis] 49.
 Plum, Mary (Haselrigg), 16.
Plumbe, 121.
 PLUMBE, 121.
 Alicia, 121.
 Alicia (Faunt), 121.
 Anna, 121.
 Cornelia = Smith, 121.
 Elizabeth, 121.
 Elizabeth (Fortescue), 121.
 John, 121, 124.
 Judith, 121.
 Katherina = Stafford, 121.
 Margareta (Lindsey), 121.
 Margareta = Lloyd, 121.
 Maria, 121.
 Maria (Duport), 121, 124.
 Maria = Pugh, 121.
 " = Thornes, 121.
 Ralph, 121.
 Thomas, 121.
 Walter, 121.
 William, 121.
 — = Redham, 121.
 Pochet, Andrew, 17.
 Dorothy (Gray), 17.
Pochin, 39, 106.
 POCHIN, 106.
 Alicia, 106.
 Alicia (Willoughby), 106.
 Alicia (Brookesby), 106.
 Barbara = Chambers, 52,
 106.
 Dorothea, 106.
 Dorothea = Cogam, 106.
 Edward, 106.
 Elizabeth, 106.
 Elizabeth (Shirley), 106.
 Ellina = Harrington, 106.
 Francis, 106.
 George, 39, 106.
 Gracia, 106.
 John, 106.
 Katherina, 106.
 Katherin = Skeffington,
 106.
 Katherin (Blewett), 106.
 Margaret, 106.

POCHIN—*continued.*

- Maria, 106.
 Maria (Moore), 106.
 Maria (Palmer), 39, 106.
 Mathew, 106.
 Pasca, 106.
 Richard, 106.
 Robert, 106.
 Valentine, 106.
 William, 39, 52, 106.
 — (Dove), 106.
- Pocklington, Margaret (Staresmore), 6.
 Pollard, Henry, 37.
 John, 152.
 Katherina (Cowper), 152.
 Mary (Purifoy), 37.
- Polson, Alexandre, 124.
 Anna (Duport), 124.
- Poole, Dorothea (Cave), 66.
 Elizab. (Mutton), 59, 80.
 Henry, 66, 72.
 Henry [L^d Montague], 72.
 Jana (Nevill), 72.
 Katherin = Hastings, 72.
 Margaret = Chamberlaine, 137.
 Margaret (Plantagenet), 72.
 Rafe, 59, 80.
 Richard, 72.
 — = Gee, 180.
 — = Noell, 114.
- Pooley, Maria = Lany, 196.
Porte, 48.
- PORTE, 48 [or PORT].
 Dorothea = Hastings, 73.
 Emmala (Montacute), 48.
 Henry, 48.
 James de, 48.
 John, 73.
 Thomas, 48.
 Thomas de, 48.
 — (Higatt), 48.
- Porter, Anne = Hartop, 9, 196.
 Austin, 10.
 John, 9, 196.
 Juditha = Cave, 122.
 William, 122.
- Portlington, Elizab. (Legard), 19.
 Thomas, 19.
- Potter, Anna = Perin, 198.
 Raph, 198.
- Pouchin, George, 112.
 Katherin (Skeffington), 112.
- Poultney*, 70.
- POULTNEY, 70.
 Adam Neale de, 70.
 Agnes = Ashby, 14.
 Dorothea = Hodgis, 154.
 Ellena = Owen de Poultney, 70.
 John, 7, 154.
 Johanna = Spigurnell, 70.
 Jone = Purifoy, 33.
 Margareta (—?—), 70.
 Matilda (—?—), 70.
 Micheal, 154.
 Owen de, 70.
 Robert, 70.
 Roisia = Sherard, 10.

POULTNEY—*continued.*

- Sara = P, 70.
 Sir John, 33.
 Sir Thomas, 10, 14, 63.
 — = Belgrave, 96.
 — = Prestwich, 63.
- Powchen, George, 8.
 Katherine (Skeffington), 8.
 Power, Anna = Lincoln, 106.
 Walter, 106.
- Powtrell, Dorothea = Pilkington, 78.
 Thomas, 78.
- Poyner, Dorothea = Corbet, 177.
 Thomas, 177.
- Prate, Johanna (Neale), 163.
 Richard, 163.
- Pratt, Ann = Dison, 85.
 Elizabeth = Brookesby, 85.
 Elizabeth (Marston), 101.
 Ellen (Aston), 85.
 Henry, 85.
 Hugh, 85.
 Johanna (Gore), 85.
 John, 84, 85.
 Margareta = Goodman, 84.
 Thomas, 85.
 — = Hartop, 9, 197.
- Prestgrave, Francis, 104.
 Elizab. = Ruding, 104.
- Preston*, 10.
- Preston, Alicia (Griffith), 205.
 Richard, 205.
- PRESTWICH, 63 [also Prestwith].
 Alice (Gifford), 63.
 Edmond, 63.
 Elizabeth (Woode), 63.
 John, 63.
 Mary (Clinton), 63.
 Richard, 63.
 Rose = Digby, 63.
 Sir Roger, 63.
 Thomas, 63.
 William, 63.
 — (Poultney), 63.
- Printoft — (Bradshaw), 44.
- Pudsey, Anna (Gee), 181.
- Pugh, Maria (Plumbe), 121.
 Roger, 121.
- Purifoy*, 32.
- PURIFOY, 32, 33, 34, 35, 36, 37.
 Alice, 33, 37.
 Alice (Denton), 33, 35.
 Alice (Faunt), 28, 37, 121.
 Annis (—?—), 32.
 Anne, 33, 35, 36, 37.
 Anne (Phetiplace), 33, 35.
 Anne (Windsor), 33, 36.
 Anne = Jarvis, 34, (71).
 Anne = Kirchewall, 34.
 Anne (Bingham), 34.
 Anne (Perrin), 34.
 Anne (Rooke), 35.
 Anne (Furtho), 36.
 Anne = Gerveis, 71.
 Arthur, 37.
 Barbara (Dixwell), 35.
 Beatrix (Chibenhurst), 33.

PURIFOY—*continued.*

- Beatrix (Chiselhurst), 36.
 Blendina (Goodwyn), 36.
 Charles, 33.
 Ciceley, 35.
 Ciceley (Goodwyn), 33, 36.
 Clemence (Lidiard), 35.
 Diolata, 36.
 Dorothea, 34, 37.
 Dorothea = Bradshaw, 37, 44.
 Edward, 33, 34, 35, 36.
 Elianor (Baskerville), 37.
 Elizabeth, 33, 34, 35, 30, 37.
 Elizabeth (Brome), 32, 33.
 Elizabeth = Knightly, 33.
 Elizabeth = Palmer, 33.
 Elizabeth (Sanders), 34.
 Elizabeth (Whetell), 34, 45.
 Elizabeth (Bradshaw), 34, 44.
 Elizabeth (Palmer), 39.
 Elizabeth = Ackworth, 35.
 Elizabeth (Williams), 35, 4.
 Francis, 33, 34, 35, 36, 37, 179.
 Francisca = Smalley, 37, 76.
 Frideswed, 34.
 Gamaliel, 37.
 George, 33, 34, 36, 37, 104.
 Henry, 33, 37.
 Humphrey, 28, 37, 121.
 Isabell, 33, 34.
 Isabell = Sutton, 33.
 Isabell (Brome), 35.
 Isabell = Goodwyn, 35.
 Isabell (Bradshaw), 37, 44.
 James, 35.
 Jane, 33, 35, 37.
 Jane = Wright, 37.
 Jane (Davenport), 37.
 Jana (Vincent), 50, 81.
 Janill, 36.
 Joane (Poultney), 33.
 Joane (Wistowe), 33.
 Joane = Staresmore, 34.
 Joan (Vincent), 34.
 Joane = Ruding, 104.
 Jocosa, 34.
 Joyce, 35, 37.
 Joyce (Purifoy), 33, 36.
 Joyce = Ruddings, 34.
 Joyce (Hardwick), 34, 37.
 Joyce = Purifoy, 33, 34.
 Joyce = Holt, 37.
 John, 32, 33, 34, 35, 36, 37, 39.
 Judith, 37.
 Katherin, 37.
 Katherin (Wellesborough), 32.
 Katherin = Staresmore, 33.
 Katherin (Broyesfeild), 35.
 Katherin = Wightman, 37.
 Katherin (Wigston), 37.
 Katherine (Staresmore), 6.
 Lucas, 36.
 Magdalena = Grey, 139.
 Margaret, 37.

PURIFOY—*continued*.

Margaret (Shelford), 32.
 Margaret = Dall, 37.
 Margaret (Knightley), 33.
 Margaret = Catesby, 33.
 Margery = Feilding, 33.
 Margery (Fitz-Harbert), 33.
 Margery (Pichley), 34.
 Margery = Salisbury, 37.
 Margery (Nicolls), 187.
 Margery (Motton), 59.
 Marian (Ayott), 32.
 Mary (Wenle), 32.
 Mary = Thorne, 33, 36.
 Mary = Bellers, 37.
 Mary (Boys), 33.
 Mary = Farmer, 179.
 Mary = Pollard, 37.
 Martyn, 35.
 Mawdelin = Grey, 37.
 Michael, 34, 37, 39, 76, 187.
 Nathaniel, 37.
 Nicholas, 33, 34, 35, 37, 39,
 50, 71, 81.
 Phillip, 32, 35.
 Ralph, 34, 37.
 Richard, 33, 36.
 Robert, 37.
 Simon, 32, 35.
 Susan, 36, 37.
 Susan = Jenney, 35.
 Susanna = Goodall, 37.
 Thomas, 32, 33, 35, 36, 37.
 William, 32, 33, 34, 35, 36,
 37, 39, 59.
 — (Butler), 39.
 — = Bradshaw, 161.
 — (Bradshaw), 37.
 — (Perkins), 39.
 — (Langham), 37.
 — (Staresmore), 99.
 Purshull, Anna (Caldwell),
 192.
 Edward, 192.
 Pury, Anne = Davers, 40.
 John, 40.
 Pusey, Rowland, 109.
 Quincy, Roger [E. of Win-
 chester], 86.
Raby, 21.
 Raglin, Margt = Shipward,
 82.
 Randall, Faith, 130.
 Francis, 130.
 Johanna (Thame), 130.
 John, 130.
 Robert, 130.
 Rarwick, Gabriell, 142.
 Jana (Everard), 142.
 Ravens, Dorothea (Belgrave),
 69.
 John, 69.
 Rayman, Winifred = Baghot,
 151.
 Reade, Alice = Pace, 63.
 Alicia = Bent, 158.
 Richard, 63.
 Roger, 158.
 Redham — (Plumbe), 121.
 Redman, Jana = Dalton, 27.

Redman—*continued*.

John, 27.
 Reeve, Thomas, 175.
 Francisca = Everard, 175.
 Reimes, Florence (Bradshaw),
 44.
 Reinger, Mary (Beaumont), 60.
 Reynolds, Ann = Burton, 160.
 Robert, 160.
 Repin, Richard, 162.
Repington, 42.
 REPINGTON, 42.
 Anne = Cocking, 42.
 Edith, 42.
 Edward, 42.
 Francis, 42.
 Francis (Stanford), 42.
 Humfrie, 42.
 John, 42.
 Katherin = Burton, 42.
 Margaret = Fisher, 42.
 " = Kendall, 42.
 Mary = Swinfen, 42.
 Maude (Cotton), 42.
 Richard, 42.
 Thomas, 42.
 William, 42.
 Replingham, Anna = Armes-
 ton, 176.
 Beatrix (Legard), 19.
 Edward, 176.
 Peter, 19.
 Reven, Maria = Allen, 109.
 Reyner, Mary (Beaumont), 30,
 171.
 William, 30, 171.
 Reynes, Dorothy (Barret), 107.
 Jocosa = Barret, 107.
 Nicholas, 107.
 Robert, 107.
 Ribbesford, John, 167.
 Matilda = Temple, 167.
 Ridlington, Baron of, 4.
 Rigden, Anne (Villers), 31.
 Thomas, 31.
 William, 31.
 Rigmeden, Dorothy (Beau-
 mont), 60, 172.
 Rinell, Richard, 162.
 Ringescott, Maria = Temple,
 167.
 William, 157.
 Ringley, Edmond, 5.
 Katherin (Walshall), 5.
 — = Lawley, 5.
 Ripariis *vel* Rivers, E., 74.
 Ripington, Katherin = Bur-
 ton, 57.
 William, 57.
 Ripon, John de, 162.
 Risley, Dorothea (Temple),
 168.
 Paul, 168.
 Rison — = Legard, 19.
 Rivers, E. [Grey], 139.
 E. [Woodvile], 74.
Robertes, 117.
 Roberts, 203.
 ROBERTES and ROBERTS,
 117, 118, 203.
 Alicia, 117.
 Alicia (Creekland), 117.

ROBERTES and ROBERTS—*cont.*

Anna, 118, 203.
 Anna = Perkins, 118.
 Anna (Burnaby), 203.
 Barnes, 203.
 Dorothea, 118.
 Dorothea (Gerveis), 118.
 Dorothea (Lawn), 118.
 Edmond, 203.
 Edmund, 117.
 Elianor (Diglin), 118.
 Elionora, 203.
 Elinora, 118.
 Elizabeth, 118.
 Elizabeth (Whitton), 117.
 Elizabeth = Sacheverill,
 117.
 Elizabeth = Wright, 118.
 Elizabeth = Wyndover,
 203.
 Elizabeth = Saunders, 203.
 Faith (Pattinson), 203.
 Francisca (Bale), 118, 142.
 Francisca = Franklin, 203.
 Francis, 203.
 George, 118.
 Gervase, 118.
 Henry, 117.
 Jana, 117.
 Jana (Gomond), 117.
 Jana (Dakins), 117.
 Jana = Geary, 118.
 Jana = Glover, 203.
 Jocosa (Staresmore), 6, 117.
 Jocosa = Bale, 118, 141.
 Jocosa, 118.
 John, 117, 118.
 Katherina, 118.
 Katherin = Cooke, 118.
 Katherin (Temple), 117.
 Katherin (Elkinton), 118.
 Katherin = Ciampanti, 203.
 Lucia = Acres, 118.
 " = Chancy, 118.
 Margareta (Johnson), 117.
 Maria, 117, 203.
 Maria (Chester), 117.
 Maria (Glover), 203.
 Michael, 118.
 Peter, 118.
 Richard, 117, 118, 141.
 Thomas, 117, 118, 203.
 Walter, 117.
 William, 6, 117, 118, 142, 203.
 — = Acton, 117.
 — (Bainham), 117.
 — (Hickson), 117.
 — (Worship), 117.
Robinson, 182.
 ROBINSON, 182.
 Elizabetha, 182.
 Henry, 182.
 John, 182.
 Lucia (Webb), 182.
 Lucy, 182.
 Sara, 182.
 Sara (Bainbrig), 182.
 Thomas, 182.
 William, 182.
 Rochford, Henry, 7, 110.
 Johanna = Stanhop, 7, 110.
Rochford, 7.

- Rocke, Maria = Everard, 142.
 Rockley, Anna = Gray, 74.
 Isabell (Clare), 74.
 Raphc, 74.
 Rodes, Maria = Meade, 151.
 Rodney, Marg^t = Burdet, 24.
 Marg^t = Wodhull, 24.
 Roe, Katherin (Cotes), 94.
 Roger, 94.
 Rogers, Elizab. = Savile, 93.
 Simon, 93.
Rolleston, 21.
 Rolleston, Amphelicia = Nevill, 21.
 Lady of, 21.
 Lord of, 21.
 Rolt, Brigetta = Dixy, 116.
 Francisca (Dixy), 116.
 John, 9, 197.
 Katherin (Staveley), 136.
 Maria = Hartop, 9, 197.
 Thomas, 136.
 Walter, 116.
 Rooke, Ann = Purifoy, 35.
 ROOS, 92.
 Elizabeth, 92.
 Elizabeth (Osberne), 92.
 Friswold, 92.
 Goditha, 92.
 Jacobus, 92.
 Jeaira, 92.
 Joan = Edward, 31.
 Johanna, 92.
 Jone (Donne), 7.
 Margaret = Gray, 17, 74.
 Margaret (Peko), 92.
 Margaret (Warde), 92.
 Maria, 92.
 Milo, 92.
 Richard, 92.
 Robert, 92.
 Rosa, 92.
 Thomas, 7, 31, 92.
 Wilfredus, 92.
 William, Lord, 74.
 Roose, Jone (Deane), 7, 110.
 Sir Robert, 7, 110.
 Thomas, 110.
 Roper, Barbara (Devereux), 73.
 Dorothe, 73.
 Edward, 73.
 Francis, 73.
 Hellena = Morton, 131.
 Henry, 73.
 Henry Hastings, 73.
 Jocosa (Hastings), 73.
 Matilda (Longford), 73.
 Walter, 73.
 William, 73.
 Ros, Goditha = Skeffington, 111.
 Thomas, 111.
 Roskin, Jasper, 75, 186.
 Margaret = Lacy, 75, 186.
 — (Bellers), 75, 186.
 Rosse, Edward, 133.
 Lord [*de Ros*], 17.
 Marg^t = Carrington, 131, 145.
 Maria = Croft, 146.
 Maria = Wilcocks, 136.
- Rosse—*continued*.
 Robert, 145.
 Sir Robert, 131.
 Rous — = Humphrie, 62.
 Rouse, Edward, 16.
 Elizabeth = Neale, 164.
 Maria = Hasclrigg, 16.
 William, 162.
 Routhe, Constance = Legard, 19.
 Sir John, 19.
 Rowell, Johanna = Strelley, 194.
 Nicholas, 194.
 Rowleston, Agnes (Turvile), 54.
 Thomas, 54.
 Ruddings, John, 34.
 Joyce (Purifoy), 34.
Rudiard, 202.
 RUDIARD, 202.
 Anna (Luther), 202.
 Anthony, 202.
 Benjamin, 202.
 Charles, 202.
 Edmund, 202.
 Elizabeth (Bidell), 202.
 James, 202.
 John, 202.
 Joseph, 202.
 Laurence, 202.
 Margareta (Shilton), 202.
 Nicholas, 202.
 Ralph, 202.
 Rebecca (Steward), 202.
 Richard, 202.
 Robert, 202.
 Thomas, 202.
 William, 202.
Ruding, 104.
 RUDING, 104.
 Anna (Driver), 104.
 Catherina, 104.
 Christian, 104.
 Dorothea = Symerell, 104.
 Dorothy (Wakefeild), 104.
 Elizabeth, 104.
 Elizabeth (Presgrave), 104.
 Francisca, 104.
 Franciscus, 104.
 George, 104.
 Gray, 104.
 Jane = Gage, 104.
 Jana = Beauchamp, 104.
 Joane (Purefoy), 104.
 John, 104.
 Martha, 104.
 Michael, 104.
 Richard, 104.
 Suzan (Watson), 104.
 Walter, 104.
 William, 104.
 Rudkin, Maria (Wilcocks), 136,
 Thomas, 136.
 Rugeley, Alice = Brasbridge, 43.
 John, 43.
 Ruskin, Elizab. (Bellers), 30.
 William, 30.
 Russell, Anna = Wigley, 97.
 Thomas, 97.
- Rutland, E. of [Manners], 30.
 Sabin — = Gore, 85.
 Sacheverell, Anne (Leeche), 45.
 Anna = Whitalph, 98.
 Eliz. (Noble), 115.
 Ellina = Digby, 199.
 Francis, 98.
 John, 45, 76.
 Jone (Curson), 45.
 Patrick, 45.
 Raphc, 45, 199.
 Robert, 45.
 Sir Robert, 45.
 Thomas, 115.
 William, 45.
 — = Kebell, 56.
 — = Slorrey, 46.
 Sachevill, Elizab. (Robertes), 117.
 John, 117.
 Sadler, Margeria = Kendall, 91.
 St Andrew, Barbara, 112.
 Jane, 112.
 John, 112.
 Maria (Skeffington), 112.
 William, 112.
 St John, Barbara = Villers, 30.
 Margeria = Grey, 139.
 Oliver, 139.
 of Bletsho, Lord, 139.
 Sir John, 30.
 — = Corbet, 177.
 St Leger, Elizabeth (Digby), 41.
 St Loo, Roger, 51.
 Sainte, Jocosa = Smalley, 77.
 William, 77.
Salisbury, 185.
 SALISBURY and SALISBERIE, 185, 186.
 Abigall, 185.
 Alicia, 186.
 Ambrose, 185.
 Anna, 185.
 Anna (Creswell), 185.
 Cornelia, 186.
 Cornelia (Berie), 185.
 Edward, 185, 186.
 Elizabeth, 186.
 Elizabeth (Hopkins), 185.
 Elizabeth = Michel, 185.
 Elizabeth (Kirke), 185.
 Elizabeth = Bent, 185.
 Elizabeth = Muckleslow, 185.
 Elizabeth (Burgalaine), 185.
 Elizabeth (Warde), 186.
 Francisca (Wightman), 185.
 Henry, 81.
 Hester = Barwell, 185.
 Jana, 185.
 Jana = Brooke, 186.
 John, 185, 186.
 Jone (Gillett), 185.
 Joseph, 185.
 Katherin (Salisberie), 185.
 Lidia, 185.
 Margaret = Lavender, 185.

- SALISBURY *and* SALISBERIE—*cont.*
 Margery (Purifoy), 37.
 Maria = Vincent, 81.
 Maria, 185, 186.
 Martha, 185.
 Nathaniell, 185, 186.
 Paul, 186.
 Raph, 37.
 Sara, 185.
 Sara = P, 185.
 Samuel, 185.
 Richard, 185, 186.
 Robert, 185.
 Thomas, 185, 186.
 William, 50, 185, 186.
 — = Vincent, 50.
 — (Wright), 185.
 Salisbury, C^{ess} of (Plantagenet), 72.
 George, Duke of, 72.
 Saltmarsh, Hellena = Pate, 89.
 Thomas, 89.
 Salvaine — = Grey, 139.
 Samborne, Blanch (Burdet), 24.
Sampson, 122.
 Sampson, Maria = Cave, 122.
 Robert, 122.
 Samson, Alice (Bent), 158.
 Maria (Everard), 175.
 Thomas, 175, 158.
 Sanders, Dorothy = Belgrave, 67.
 Elizabeth = Purifoy, 34.
 Laurence, 67.
 Sandes, Hester = Temple, 168.
 Michaell, 168.
 Sandey, Bedford al's, 51.
 Sandford, Eliz. (Billne), 30.
Sandon, 68.
 Sandon, Isabell = Belgrave, 68, 96.
 William, 68, 96.
 Sands, Briget (Smith), 66.
 Sapcotts, Anne = Brookesby, 49.
 Elizabeth = Beaumont, 171.
 Henry, 171, 175.
 Isabell (Plesington), 49.
 Thomas, 49.
 Sarson, George, 102.
 Maria (Laurence), 102.
 Saunders, Ambrose, 191.
 Anna = Villers, 31.
 Anna = Beaumont, 60, 171.
 Andry = Villers, 30.
 Clement, 68.
 Dorothy (Belgrave), 68.
 Edward, 126, 148, 168.
 Elizabeth (Roberts), 203.
 Jana = Halford, 145.
 Joane (Farnham), 68.
 Margaret (Cave), 126.
 Maria = Dawes, 98.
 Martha = Cotton, 191.
 Mathew, 145.
 Millicent (Temple), 168.
 Millicent = Whalley, 148.
 Sir Edward, 31.
 William, 30, 60, 68, 171.
- Saunderson, Frances = Ashby, 184.
 Frances = Hollingsworth, 184.
 Katherina (Bale), 141.
 Maria = Bock, 119.
 „ = Sturton, 119.
 Thomas, 119, 141, 184.
 Savage, Agnes = Neale, 164.
 Anna (Bent), 158.
 Anna = Gee, 181.
 Edward, 9, 99.
 Jane (Staresmore), 9, 99.
 John, 82, 181.
 Lawrence, 82.
 Robert, 158.
 Ursula = Shipward, 82.
 William, 164.
Savill, 93.
 SAVILL, 93.
 Anna = Allen, 93.
 Anna (Heron), 93.
 Anna (Pigeon), 93.
 Anthony, 93.
 Edward, 93.
 Elinora, 93.
 Elizabeth, 93.
 Elizabeth (Rogers), 93.
 Elizabeth = Marston, 101.
 Ellinor (Astoll), 93.
 George, 93.
 Humphric, 93.
 Jana, 93.
 Jana = Bridges, 93.
 Jana = Chester, 138.
 John, 93, 101.
 Katherina, 93.
 Katherina (Blaby), 93.
 Lavinia, 93.
 Martha (Villers), 93.
 Nicholas, 93, 138.
 Richard, 93.
 Robert, 93.
 Susanna (Beeson), 93.
 Thomas, 93.
 William, 93.
 Sawier, Anna (Goodman), 84.
 Edmond, 84.
 Saxby, Margaret = Cave, 126.
 Thomas, 126.
 Say, Richard Fines, Lord, 30.
 Scargill, Katherin (Peck), 146.
 Scot — = Faunt, 28.
 Scott, Alicia = Bankes, 150.
 John, 150.
 Scrimshaw, Eliz. = Perin, 198.
 Scams, Thomas, 206.
 Margareta = Brett, 206.
 Seamour, Anna = Nicolls, 187.
 David, 187.
 See, Maria de (Cave), 125.
 Piers de, 125.
 Segar, William [*Garter*], 123.
Segrave, 18.
 SEGRAVE, 18.
 Carolus, 18.
 Cornelia (Duport), 124.
 Edward, 18.
 Isabella = Gregorie, 188.
- SEGRAVE—*continued.*
 Ralph, 18, 124.
 William, 18.
 — = Vt Bindon, 18.
 — = Eyre, 193.
 — (Gedney), 18.
 Seimer, Catherine (Gray), 75.
 Edward [E. of Hertford], 75.
 Seller, Ellena = Dawes, 98.
 Sercole — (Ashby), 14.
 Sevens — = Peck, 147.
 Sewall, origin of Shirley, 25.
 Fulcher son of, 25.
 Henry son of, 25.
 son of Henry, 25.
 Sewell, Elinor (Vincent), 81.
 John, 81.
 Seyton, John, 129.
 Isabella (—p—), 129.
Sharpe, 89.
 SHARPE, 89.
 Alicia (Chester), 138.
 Anna (Chester), 138.
 Brigetta = Chester, 138.
 Eustachius, 89.
 Hugo, 89.
 John, 89, 138.
 Margeria (Dixson), 89, 195.
 Richard, 138.
 Robert, 138.
 William, 89.
 — (Burton), 89.
 Shaw, Isabella = Hollingsworth, 84.
 Shawe, Anna = Needham, 100.
 Thomas, 100.
 Shefe, Rebecca = Heselrig, 16.
 Thomas, 16.
 Shefeild, Maria = Peper, 103.
 Richard, 103.
 Robert, 125.
 — (Lounde), 125.
 Sheffield, Jane = Shirley, 26.
 Jane = Hastings, 26.
 Sir Robert, 26.
 Sheldon, Anne (Bwooke), 65.
 Anne = Turvile, 55.
 John, 55.
 Shelford, Margt = Purifoy, 32.
 Symon de, 32.
 Shelley, Anne = Shirley, 26.
 John, 26.
Shelton, 68.
 Shelton, Elizab. = Belgrave, 68, 95.
 Thomas, 68, 95.
 Shepard, Elizab. = Gervois, 71.
 Elizab. = Sutton, 71.
 Harman, 108.
 Margaret (Cooke), 108.
 Shepee, Alice (Swynfen), 134.
 John, 134.
 — = Kendall, 90.
Shepey, 44.
 Shepey, Agnes (Burdet), 24.
 Alicia (Walcott), 86.
 William, 24.
Sherard, 10.

- SHERARD and SHERRARD,
 10, 88.
 Abigail (Cave), 10.
 Anne (Hubarke), 10.
 Anne (Hubert), 38.
 Anne = Ellis, 10.
 Anne (Grigorie), 10.
 Benet, 10.
 Bridget (Digby), 10.
 Ciceley, 88.
 Dorothie, 10.
 Edward, 88.
 Elizabeth, 10, 88.
 Elizabeth (Persall), 88.
 Elizabeth (Cotton), 88.
 Ellen, 10.
 Francis, 10.
 Francis (Harrington), 10.
 Galfred, 10.
 Galfridus, 88.
 George, 10, 88.
 Hugo, 88.
 Isabell (Harpur), 10.
 Joanne, 10.
 John, 10, 88.
 Johanna (Tirrell), 88.
 Joyce, 10.
 Joyce (Ashby), 10, 14.
 Katherin, 10.
 Laurence, 10, 88.
 Margaret (Helwell), 10.
 Margaret = Black, 10.
 " = Durrant, 10.
 Mary, 88.
 Ralph, 88.
 Richard, 10, 88.
 Robert, 10, 38.
 Roisia (Poultney), 10.
 Rose, 10.
 Rowland, 10.
 Samuell, 88.
 Sir Phillip, 10.
 Sir William, 10.
 Susan, 10.
 Thomas, 10.
 William, 10.
 — = Beric, 207.
 — (Digby), 10.
 — (Folville), 10.
 — (Parre), 88.
 — (Porter), 10.
 — (Woodford), 10.
 SHERMAN, 203, 204.
 Anna, 204.
 Anna = Browne, 204.
 Anna (Cave), 128, 204.
 Anthony, 203.
 Bartholmew, 203.
 Elianor = Jermin, 204.
 Elizabeth, 204.
 Elizabeth = Browne, 204.
 Faith (Lany), 203.
 Faith = Ballard, 204.
 Faith = Hemming, 204.
 Francis, 203.
 Henry, 203.
 Jana, 204.
 Jeames, 203.
 John, 128, 203, 204.
 Margeria = Duck, 204.
 Maria (Lascelles), 155, 204.
 Millicent, 204.
- SHERMAN—continued.
 Owen, 204.
 Richard, 203, 204.
 Thomas, 203, 204.
 William, 155, 203, 204.
 — = Lockwood, 203.
 — (Thwaites), 204.
 Sherman, 203.
 Sherrard, 88.
 Shilton, Agnes = Digby, 40.
 John, 40, 202.
 Margareta = Rudiard, 202.
 Maria = Temple, 168.
 Robert, 168.
 Shipham — = Whiting, 92.
 Shipton, Roger, 68, 96.
 Susanna = Belgrave, 68, 95.
 SHIPWARD, 82.
 Anna, 82.
 Anna = Hutchin, 82.
 Barbara (Hutchin), 82.
 Christopher, 82.
 George, 82.
 Henry, 82.
 Isabella = Leigh, 82.
 John, 82.
 Katherin, 82.
 Margaretta (Raglin), 82.
 Maria = Houghton, 82.
 Maria (Docura), 82.
 Mathew, 82.
 Maurice, 82.
 Ursula, 82.
 Ursula (Savage), 82.
 Walter, 82.
 William, 82.
 SHIRLEY, 25, 26, 27.
 Agnes (Walton), 25.
 Alicia = Brookesby, 49, 201.
 Alice = Chancellor, 26.
 Alice (—?—), 25.
 Alice, 26.
 Anne, 26, 27.
 Anne (Shelley), 26.
 Anne = Fernwold, 26.
 Anne (Kempe), 27.
 Beatrix (Brewes), 25.
 Beatrix = Brome, 25.
 Beatrix = Eldrington, 26.
 Cicely, 27.
 Ciceley = Ledes, 26.
 Dorothy (Gifford), 26.
 Dorothy (Wroughton), 26.
 Dorothy (Devereux), 26.
 Edward, 26.
 Elinor (Willoughby), 26.
 Elizabeth, 25, 26, 27.
 Elizabeth = Hasillridge, 15.
 Elizabeth (Blount), 25.
 Elizabeth (Guilford), 26.
 Elizabeth (Marmaduke), 26.
 Elizabeth = Lce, 26.
 Elizabeth = Michell, 26.
 Elizabeth, 26.
 Frances (Berkley), 26.
 George, 26.
 Henry, 26.
 Isabell (Basset), 25.
 Isabella = Cockaine, 25.
 Isabella = Dawney, 26.
- SHIRLEY—continued.
 Jane, 27.
 Jane (Bellengham), 26.
 Jane (Sheffield), 26.
 Jane = Dawney, 26.
 Jane (Lovet), 26.
 Jeames, 25.
 Johanna (Basset), 25.
 John, 26.
 Leticia, 26.
 Lucy (Ashton), 25.
 Margaret, 26, 27.
 Margaret (Waldeshof), 25.
 Margaret = Danvers, 86.
 Margaret (Staunton), 25.
 Maria, 26, 27.
 Maria (Harper), 26.
 Mary (Isley), 26.
 Nicholas, 25.
 Ralph, 25, 26, 86.
 Sanche, 26.
 Sir Anthony, 27.
 Sir Hugh, 25.
 Sir Ralphe, 15, 25, 26.
 Sir Richard, 26.
 Sir Thomas, 25.
 Thomas, 26.
 William, 26.
 Shorte, Ellena (Wigley), 97.
 Richard, 97.
 Shugborow — = Harcourt, 39.
 Shuger, Arthur, 122.
 Francisca (Cave), 122.
 Shukbrough, John, 166.
 Margaret = Harcourt, 166.
 Shukebrough, Edward, 192.
 Elizab. (Cotton), 192.
 Sidney, Lucy = Harington, 59.
 Sir William, 59.
 Sinner, Elizab. = Smith, 66.
 Thomas, 66.
 Skeffington, 111.
 SKEFFINGTON, or SKE-
 FINGTON, or SKEU-
 INGTON, 7, 8, 110,
 111, 112.
 Agneta, 112.
 Alice, 8.
 Alicia (Cave), 111.
 Alice = Bandon, 112.
 Anna, 8, 111.
 Anna (Digby), 8, 41, 111.
 Anne = Ludford, 8, 112.
 Anne = Cheselden, 20.
 Anthony, 8, 112.
 Christopher, 8.
 Dorothy = Hunt, 8, 112.
 Edward, 8, 112.
 Elizabeth, 8, 111.
 Elizabeth = Ingleby, 8,
 112.
 Elizabeth = Griffith, 111.
 Elizabeth (Dering), 111.
 Elizabeth = Danvers, 86,
 111.
 Elizabeth = Jetter, 111,
 112.
 Elizabeth (Danvers), 111.
 Elizabeth = Brome, 112.
 Francis, 8, 112.

SKEFFINGTON, or SKEFINGTON,
or SKEUINGTON—cont.

Galfridus, 7.
George, 8, 111, 112.
Goditha (Ros), 111.
Henry, 112.
Isabell (—?—), 7, 110.
Isabell, 8, 111.
Isabell = Belgrave, 8, 96,
112.
Isabella (Biron), 8, 112.
James, 8, 111.
John, 7, 8, 86, 111, 112.
Johanna (Leveson), 8, 111.
Jocosa = Bendage, 112.
Jocosa = Ingarsby, 112.
Joice = Bendish, 8.
Joyce = Ingarsby, 8.
Katherin = Colley, 8, 111.
Katherin = Powchen, 8,
106, 112.
Katherin (Chetwood), 8,
112.
Katherin = Brome, 112.
Leonard, 8, 112.
Luna = Bell, 8, 112.
Margaret, 8, 112.
Margaret (Oldebeffe), 7, 110.
Margaret (Stanhop), 8.
Mabill (—?—), 7, 110.
Mary, 8.
Mary (Cave), 8, 112.
Mary = Overey, 8, 112.
Mary = Kingston, 8, 112.
Mary = Muncck, 8, 112.
Mary = St Andrew, 112.
Mathew, 112.
Petronilla (—?—), 7, 110.
Richard, 7, 110, 111.
Sir Galfrid, 7.
Sir John, 7.
Sir Robert, 7, 110.
Sir Symond, 7, 110.
Sir William, 41.
Thomas, 7, 8, 20, 96, 106,
110, 111, 112.
Ursula, 111.
Ursula (Skeffington), 111.
Ursula = Skeffington, 112.
William, 7, 20, 96, 110,
111, 112.
— (Ashby), 13, 132.
— (Bradley), 111.
— (Haselrig), 111.
Skeirshall, Marg^t = Dan-
net, 51.
William, 51.
Skeuington, 7.
SKEUINGTON, 7. [See
under SKEFFINGTON.]
Skinner, Maria = Caldwell,
192.
Skipper, Jane (Legard), 20.
Richard, 20.
Skipwith (Brasbridge), 43.
Skipwith, Henry, 66.
William, 66.
— = Smith, 66.
Sligh, Maria (Smalley), 76.
Slimun, Francesca (Morton),
184.
Robert, 184.

Slorey, Soltey *vel*, 80.
Will, 50.

Anne = Vincent, 50.
Slorrey, Anne = Vincent, 46.
Elizabeth = Neele, 46.
Richard, 46.
Thomas, 46.
William, 45, 46.
— (Beaumont), 46.
— (Sacheverell), 46.
— = Wood, 46.

Smalley, 76.

SMALLEY, 76, 77.

Adam, 77.
Alionora (—?—), 76.
Anthonius, 76.
Edward, 76.
Elizabeth = Sainte, 77.
Francisca (Purefoy), 37, 76.
Francisca = Bradshaw, 77.
George, 76.
Henry, 76.
Hester = Farington, 77.
Jana, 77.
John, 37, 76, 77.
Johanna, 76.
Jocosa (Walker), 77.
Margeria (—?—), 76.
Maria = Sligh, 76.
Maurice, 76.
Modwina = Catesby, 76.
— = Venables, 76.
Nicholas, 76.
Robert, 76.
Samuell, 77.
— = Atkins, 76.
— (Croke), 76.
— = Gulson, 76.

Smith, 21, 66, 119, 130, 131,
145.

SMITH, 22, 66, 67, 131, 132,
146.

[This includes Smith al's
Nevill, Smith al's Har-
ris, and Carrington al's
Smith.]

Agneta (Harewell), 131, 146.
Alathea, 132.
Alexander, 164.
Alicia (Duccombe), 22, 146.
Ambrose, 66, 67.
Anna, 131, 132.
Anna = Montgomerie, 67.
Anna (Bowles), 67.
Anna (Gifford), 131.
Anna (Markham), 132.
Anna = Abney, 152.
Anna (Cave), 127.
Anna = Cotton, 191.
Anthony, 66.
Briget = Norwich, 66.
— = Sands, 66.
Charles, 132.
Clara = Bendloes, 22, 146.
Clement, 22, 66, 146, 191.
Cornelia (Plumbe), 121.
Dorcas, 146.
Dorothea (Cave), 66, 128.
Dorothea (Smith), 66.
Dorothy = Barnham, 66.
— = Pagington, 66.
— = Arwaken, 67.

SMITH—continued.

Dorothea = Clifton, 131.
Dorothea = Brooke, 146.
Dorothea = Brudnell, 143.
Dorothy, 132.
Edmund, 131.
Edward, 66, 132.
Elizabeth, 67, 132.
Elizabeth = Calthrop, 66.
Elizabeth (Sinner), 66.
Elizabeth = Hall, 67.
Elizabeth = Hawkins, 132.
Elizabeth (Needham), 146.
Elizabeth (Bent), 159.
Elizabeth = Neele, 154.
Elizabeth (Bainbrig), 191.
Erasmus, 66.
Francis, 66, 131, 132, 146,
191.
Frances (Griffin), 66.
Francis = Sturton, 66, 119.
Francisca, 132.
George, 66, 67, 131.
Henry, 22, 66, 143, 146.
Hugo, 131, 145.
Humphrey, 67.
Isabell = Lowe, 66.
— = Maynard, 66.
Isabell (Toft), 131, 145.
James, 66.
Jana, 146.
Jana = Melley, 66.
Jane (Heron), 66.
Jane (Morton), 131.
Jana (Houghton), 146.
Jane = Berie, 207.
Joane, 67.
Joane = Cooe, 66.
John Carrington al's, 131,
145.
John, 66, 67, 131, 132, 145.
Joyce = Ingell, 67.
Lucia, 132.
Margaret (Cicell), 66.
Margaret (Ives), 66.
Margaret = Bery, 66.
Martha, 132.
Mary (Nevill), 22, 131, 146.
Mary (Allen), 66.
Mary = Wilkes, 66.
Mary (Holt), 131.
Mary = Manfeild, 131.
Maria (Morton), 146.
Millicent Carrington al's
(Laynham), 131, 145.
Nevill, 146.
Nicholas, 132, 159.
Rebecca (Peck), 147.
Robert, 66, 67, 131, 132,
145, 147, 153.
Roger, 66, 119.
Sir John, 146.
Sir Thomas, 22.
Sir William, 66.
Thomas, 22, 67, 121, 131,
145, 146.
Ursula, 132.
William, 22, 66, 67, 128,
146.
— (Baird), 66.
— (Houghton), 22.
— (Erdeswicke), 131.

SMITH—*continued.*

- (Greene), 66.
- (Peper), 67.
- (Woodcock), 66.
- (Woode), 131, 146.
- (Skipwith), 66.
- (Taylor), 66.
- = Caldwell, 192.
- = Marshall, 103.
- = Warde al's Farnour, 177.
- Snelling, John, 142.
- Maria (Everard), 142.
- Snoucell, Hugo, 171.
- Isabella (Beaumont), 171.
- Snowsdale — = Vincent, 81, 82.
- Snowse, Hugh, 61.
- Isabella (Beaumont), 61.
- Sodington, Isabella = Hastings, 15.
- Robert, 15.
- (Mortinall), 15.
- Soltey *vel* Storey, Richard, 80.
- Jane = Vincent, 80.
- Somerset, Ed. [E. of Worcester], 73.
- Elizabeth Hastings, 73.
- Somerville, Roger, 125.
- Catherine = Cave, 125.
- Sonde, Jana = Noell, 113.
- Southhill, Anne = Heselrigg, 15.
- Sir Henry, 15.
- Southwell, Elizabeth = Villers, 30.
- Spell, Anna = Wigley, 97.
- Richard, 97.
- Spencer, Alicia (Wincoll), 156.
- John, 156.
- Marg^t (Wincoll), 156.
- Maria (Alsop), 105.
- Richard, 105.
- William, 162.
- Spicer, Thomas, 163.
- Spigurnell, Hugo, 70.
- John, 70.
- Johanna (Poultney), 70.
- Thomas, 70.
- Spilware, Lettice = Ashton, 198.
- Thomas, 198.
- Sprig, John, 164.
- Isabella = Neale, 164.
- Sprigge, Dionisia (Halford), 144.
- Sprott, Edward, 149.
- Elizabeth = Fox, 149.
- Stacy, Anna = Cheselden, 107.
- Lucia = Bainbrig, 190.
- William, 107, 190.
- Stafford, Anna = Hastings, 72.
- Elianor (Humphrey), 62.
- Elizabeth (Burdet), 24.
- Humphrie, 24.
- Johanna = Vis^t Beaumont, 170.
- " = Knevit, 170.
- John, 121.
- Katherin (Plumbe), 121.
- Matilda = Ardern, 23.
- Matilda (Camvile), 23.

Stafford—*continued.*

- William, 62.
- [D. of Buckingham], 72, 105, 170.
- Stamford, Elizabeth (Sprott), 149.
- Thomas, 149.
- Stanbridge, Elizabeth (Lacy), 166.
- John, 166.
- Stanford, 160.
- STANFORD, 160.
- Anna (Staveley), 136, 160.
- Anne = Chamberlain, 137.
- Elizabeth (Bainbrig), 160, 182.
- Elizabeth = Fox, 160.
- Elizabeth, 160.
- Francis = Repington, 42.
- Henry, 160.
- John, 137, 160, 182.
- Margeria, 160.
- Thomas, 136, 160.
- William, 42.
- Stanhop, 7.
- Stanhop, Edmond, 111.
- Edward, 8.
- Henry, 110.
- Johanna (Rochford), 110.
- Jane (Rochford), 7.
- Katherin (Hastings), 73.
- Marg^t = Skeffington, 8, 111.
- Philip, Lord, 73.
- Sir Michall, 7.
- Thomas, 7, 110.
- Stanley, Anne (Hastings), 72.
- Cristian = Staresmore, 6.
- Elizabeth = Hastings, 73.
- Ferdinando [E. of Derby], 73.
- Francis, 6.
- Isabell = Humphrey, 62.
- " = Tanfeild, 62.
- Thomas [E. of Derby], 73.
- Stantow, Elizabeth = Haselrig, 15.
- " = Entwissell, 15.
- Elizabeth = Brookesby, 173.
- Elizabeth = Turvile, 15.
- Katherin = Turvile, 54.
- Margeria = Villers, 15.
- Thomas, 15, 54.
- = Danvers, 86.
- Stanton, 15.
- Stapleton, Anne (Cave), 125.
- Gilbert, 125.
- = Babington, 206.
- Staresmore, 5.
- STARESMORE [or Starismore], 5, 6, 99.
- Alice, 6.
- Amfillis = Kirk, 6.
- Anna = Mogg, 6.
- " = Winter, 6.
- Anna (Acworth), 6.
- Cassandra (Fulk), 5, 99.
- Christian = Marshall, 6.
- Christiana (Chippingdale), 99, 157.
- Cristian (Stanley), 6, 99.
- Cristian (Stephens), 6.

STARESMORE [or Starismore]

- continued.*
- Dorothea, 99.
- Edmond, 5, 6, 99.
- Edward, 6, 99.
- Elizabeth, 5, 6, 99.
- Elizabeth = White, 99.
- Elizabeth (Walshall), 5, 99.
- Francis, 5, 51, 81, 99, 157.
- Francis (Jones), 6, 99.
- Francesca (Brokas), 99.
- George, 6, 34, 99.
- Goditha = Carew, 6.
- Hæna, 99.
- Henry, 99.
- Ismaell, 6.
- Jacobus, 6.
- Jana = Savage, 6, 99.
- Jane = Gilman, 6.
- Joan (Purifoy), 34.
- Jane = Cooper, 90.
- Jocosa = Roberts, 6, 117.
- Johanna, 6.
- John, 5, 6, 17, 34, 99, 117.
- Katherin (Jones), 6, 99.
- Katherin (Purifoy), 6, 34.
- Lucia = Blount, 6.
- Margaret, 6.
- Margaret = Pocklington, 6.
- Margery = Grey, 17.
- " = Cruse, 17.
- Margeria = Wright, 6.
- Margeria = Grey, 6.
- Mary, 6.
- Mary (Pekelton), 5.
- Mary = Berwell, 5, 99.
- Maria (Vincent), 51, 81, 99.
- Martha (Cox), 6, 99.
- Michael, 6.
- Nathaniell, 6, 99.
- Nicholas, 5, 99.
- Richard, 6, 99.
- Sabinus, 6, 99.
- Thomas, 5, 6, 99.
- Ursula, 6, 99.
- Ursula = Martin, 6.
- Walter, 6.
- William, 5, 6, 90, 99.
- (Malory), 5.
- (Eiton), 5, 99.
- (Partrich), 5, 99.
- (Cresses), 5, 99.
- (Parr), 6, 99.
- (Dingley), 6.
- (Worshipp), 6.
- (Meidwell), 6.
- (Wolbeck), 6.
- (Bolton), 6.
- (Purifoy), 99.
- Starkey, John, 150.
- Margaret = Bankes, 150.
- Starkie, 175.
- STARKIE, 175.
- Alicia (Dethick), 175.
- Anna, 175.
- Cicilia (Winter), 175.
- Edward, 175.
- Elizabeth (Pate), 175.
- Elizabeth = Brook, 65.
- Elizabeth = Jackson, 175.
- Elizabeth = Tiltcote, 175.
- George, 175.

STARKIE—*continued.*

- John, 175.
 Katherin (Dartnoll), 175.
 Maria = Marsh, 175.
 Richard, 175.
 Robert, 175.
 Rowland, 175.
 Thomas, 175.
 William, 175.
 Staunton, Marg^t = Shirley, 25.
 Thomas, 25.
 — = Brookesby, 49.
 Staver Alianora (Baghot), 150.
 John, 150.
 STAVERLEY, 136.
 Anna = Stanford, 136, 160.
 Arthur, 136.
 Charles, 136.
 Elizabeth, 136.
 Eusebius, 136.
 Katherina = Rolt, 136.
 Lucia (Estwick), 136.
 Margeria, 136.
 Margeria (Brooke), 136.
 Temperance, 136.
 Thomas, 136, 160.
 Steines — = Farmer, 179.
 Stephens, Cristian (Staresmore), 6.
 Elizab. (Gee), 181.
 John, 6, 181.
 Sterkie, Agneta = Cotes, 94.
 Alicia (Dethick), 88.
 Robert, 88, 94.
 Thomas, 88.
 Stevens, Jane (Neale), 164.
 Johanna, 130.
 Maria (Thame), 130.
 Maria (Whitaph), 98.
 Richard, 164.
 Robert, 130.
 Thomas, 98.
 William, 130.
 Stevenson, Marg^t = Wigley, 97.
 Steward, Nicholas, 202.
 Rebecca = Rudiard, 202.
 Stiles, Thomas, 180.
 Presilla (Maye), 180.
 Stockey, Cicely (Winter), 42.
 Rowland, 42.
 Stoke, Anne (Neale), 164.
 Robert, 164.
 Theodosia, 164.
 William, 164.
 Stone, Katherin = Croft, 140.
 Henry, 194.
 Marg^t (Strelley), 194.
 William, 140.
 Story, Richard, 172.
 Maria (Beaumont), 172.
 Stoughton, Jane = Belgraue, 69.
 Strange, Ellina = Gray, 74.
 Strangways, — = Dalton, 27.
 Strelley, 194.
 STRELLEY, 194.
 Elias, 194.
 Elizabeth = Chapman, 194.
 Francisca = Clark, 194.

STRELLEY—*continued.*

- Gracia (Leife), 194.
 Henry, 194.
 Jane, 194.
 Joanna (Rowell), 194.
 Katherin (Fransum), 194.
 Margeria, 194.
 Margaret = Stone, 194.
 Nicholas, 194.
 Robert, 194.
 Sara = Gottes, 194.
 Stret, Jone (Hartop), 9, 197.
 William, 9, 197.
 Stretford, Elizabeth (Banister), 165.
 Robert, 165.
 Stringer, Maria (Hartop), 9, 197.
 Nicholas, 9, 197.
 Stroude, Agnis = Yarde, 91.
 William, 91.
 Stroughton, Anna (Belgraue), 96.
 Nicholas, 96.
 Stukeley, — (Nevill), 21.
 Sturgis, Johanna = Vincent, 96.
 Maria (Belgraue), 96.
 — = Meringe, 79.
 Sturton, 119.
 STURTON, 119.
 Anna (North), 119.
 Dorothea (Colteclough), 119.
 Edward, 119.
 Elizabeth, 119.
 Elizabeth = Ap John, 119.
 Ellena (Knyveton), 119.
 Erasmus, 119.
 Francis, 119.
 Francis (Smith), 66, 119.
 Francisca, 119.
 Francisca = Armstrong, 119.
 Gartruda = Knyveton, 119.
 George, 119.
 Humphrey, 119.
 John, 119.
 Katherin, 119.
 Margareta (Climpston), 119.
 Maria (Sanderson), 119.
 Roger, 119.
 Sara, 119.
 Thomas, 119.
 Sudley, 64.
 Suffolk, D. of [Gray], 75.
 Suliard, Eliz. (Beaumont), 172.
 Suthell, 15.
 Sutton, Alice (Howby), 29.
 Alice = Neele, 46.
 Anthony, 29.
 Elizabeth = Bellers, 29.
 Elizabeth (Shepard), 71.
 Henry, 192.
 Isabella (Purifoy), 33.
 Jana (Cotton), 192.
 John, 46.
 Sir Thomas, 29.
 Swayfeild, Augustus, 91.
 Margaret = Kendall, 91.
 Swillington, Anne (Turvile), 55.

- Swinfeen, Thomas, 133.
 Swinfeen, Anna (Cotes), 94.
 Elizab. = Elkington, 153.
 Mary (Repington), 42.
 Richard, 94, 153.
 Thomas de, 134.
 Swinfin, Richard, 133.
 Swinford, Sir Norman, 38.
 Mary (Hubert), 38.
 Swyke, Elizab. (Chaweband), 68.
 Johanna = Belgraue, 67.
 Jone = Belgraue, 68.
 Thomas, 67, 68.
 Swynfen, 134.
 SWYNFEN, 134.
 Alianora (—?), 134.
 Alicia = Shepee, 134.
 Anna = Cox, 134.
 Anna = Cotes, 134.
 Anna (Goodall), 134.
 Anna (Orleston), 134.
 Elianora (Leech), 134.
 Elizabeth (Cox), 134.
 Elizabeth = Farrian, 134.
 Elizabeth = Elkington, 134.
 Jone = Freshby, 134.
 John, 134.
 John de, 133.
 Katherin = Morris, 134.
 Richard, 134.
 Roger, al's Lichfeild, 133.
 Thomas, 134.
 William, 134.
 — (Geerie), 134.
 — (Leeson), 134.
 Syday, — = Wincoll, 156.
 Symerelle, Anne, 104.
 Dorothea (Ruding), 104.
 Lodowick, 104.
 Maria, 104.
 Symon [Bp. of Norwich], 25.
 Jone = Villers, 29.
 Talbot, Eliz. = Grey, 74.
 Thomas, 74.
 [Vis' de l'Isle], 74.
 Tanfeild, Elizabeth = Ashby, 114.
 Francis, 128.
 Isabell (Stanley), 62.
 Margaret = Cave, 128.
 Mary = Vincent, 81.
 Robert, 81.
 William, 14, 62.
 — = Vincent, 51.
 Tarlton, Anna = Cotton, 191.
 William, 191.
 Tatam, John, 109.
 Tavener, William, 134.
 Taylor, Marg^t = Mountney, 197.
 — = Smith, 66.
 Tedley, Katherin (Burdet), 24.
 Temple, 167.
 TEMPLE, 167, 168.
 Agneta (Benfow), 167.
 Alexander, 168.
 Alicia (Wydowes), 168.
 Alicia (Heritage), 168.

TEMPLE—*continued.*

Anna (Brasbridge), 167.
 Anna (Throckmorton), 168.
 Anna, 168.
 Anthony, 168.
 Benjamin, 168.
 Cuthbert, 168.
 Dorothea = Risley, 168.
 Elizabeth (Vincent), 167.
 Elizabeth (George), 167.
 Elizabeth (Burgaine), 167.
 Elizabeth = Banister, 165, 168.
 Edmond, 165, 167.
 George, 168.
 Gracia (Turville), 167.
 Henry, 167.
 Hester (Sandes), 168.
 Isabella (Barwell), 167.
 Isabella (Everton), 168.
 Jane (Beaumont), 61, 171.
 Jocosa (Lovet), 167.
 John, 168.
 Jonathan, 168.
 Joseph, 168.
 Katherin (Langley), 167.
 Katherin = Roberts, 117.
 Katherin = Parker, 168.
 Maria (Dabernon), 167.
 Maria (Ringescott), 167.
 Maria = Shilton, 168.
 Maria (Gedney), 168.
 Maria = Farmer, 168.
 Martha, 168.
 Matilda (Ribbesford), 167.
 Millicent (Jykett), 168.
 Millicent = Saunders, 168.
 Nicholas, 167.
 Paul, 168.
 Peter, 168.
 Richard, 117, 167.
 Robert, 167.
 Roger, 168.
 Susanna = Denton, 168.
 Susanna (Spencer), 168.
 Thomas, 167, 168.
 William, 61, 167, 168, 171.
 Teverey, Anne (Ashby), 13, 132.
 Anne (Crewker), 43.
 Gervaise, 13, 132.
 Thackhell, Alice = Bent, 158.
 Gracia = Bent, 158.
 William, 158.
Thame, 130.
 THAME, 130.
 Alicia (Kettle), 130.
 Christopher, 130.
 Cisley (Harmon), 130.
 Elizabeth = Jones, 130.
 Henry, 130.
 Jana, 130.
 Johanna (Bellson), 130.
 Johanna = Randall, 130.
 Johanna = Brocket, 130.
 John, 130.
 Margareta, 130.
 Margeria (Whitton), 130.
 Maria, 130.
 Maria = Stevens, 130.
 Robert, 130.
 William, 130.

Thikbrom, Ralph de, 133.
 Thorley, Johanna = Farrent, 202.
 Thorne, Mary (Purifoy), 33, 36.
 Thomas, 33, 36.
 Thornes, Edward, 121.
 Mary (Plumbe), 121.
 Thornton, Anthony, 154.
 Phoebe (Hodgis), 154.
 Throckmorton, Anna = Temple, 168.
 Anna = Digby, 41.
 Arthur, 168.
 Francis (Ashby), 14.
 Francisca = Dixy, 116.
 George, 128.
 Margaret = Cave, 128.
 Mary = Burdet, 24.
 Robert, 24.
 Sir George, 41.
 Sir Robert, 24.
 Thurgood, — = Whiting, 92.
 Thurland, Alice (Nevile), 21.
 Thwaites, — = Sherman, 204.
 Tilcott, Edward, 175.
 Elizabeth (Starkie), 175.
Tilley, 69.
 Tilson, Anne = Croft, 140.
 John, 140.
 Tindall, Alicia = Ashton, 199.
 Katherina = Ashton, 199.
 Richard, 199.
 Tirrell, Johanna = Sherrard, 88.
 Thomas, 88.
 Tiringham, Eliz. (Bainbrig), 182.
 Robert, 182.
 Toakey, Martha = Hodgis, 154.
 Thomas, 154.
 Todd, Henry, 27.
 Jane (Dalton), 27.
 Toft, Isabella = Smith, 131, 145.
 William, 131, 145.
 Tokeby, Robert de, 129.
 Tookey, Elizab. = Aston, 85.
 Touchbourne, Alice = Price, 63.
 Tounley, Jane (Legard), 20.
 Robert, 20.
 Tracy, Agnes (Digby), 40.
 William, 40.
 Tresham, Abigal (Caue), 10.
 Henry, 10.
 Thomas, 10.
Trinnell, 176.
 TRIMNELL, 176.
 Ann (Fauknor), 176.
 Basill, 176.
 Briget, 176.
 Dorothea, 176.
 Fardinando, 176.
 Goditha (Britaine), 176.
 George, 176.
 Jana, 176.
 John, 176.
 Lucia, 176.

TRIMNELL—*continued.*

Lucia (Makepeace), 176.
 Maria, 176.
 Roger, 176.
 Thomas, 176.
 William, 176.
 Trinnel, Trinnell al's, 176.
 Trussel, John, 128.
 Margaret = Caue, 128.
 " = Cope, 128.
 Tuffe, Frances = Chester, 138.
 Ralphe, 138.
Turner, 95.
 TURNER, 95.
 Edward, 95.
 Elizabeth, 95.
 Francisca, 95.
 Jocosa = Hunne, 95.
 Jocosa (Chamberlaine), 95.
 John, 95.
 Margereta (Breton), 95.
 Maria (Masterson), 95.
 Richard, 95.
Turpen, 69.
 Turpen, Elizabeth = Beaumont, 61, 171.
 Sedwina = Belgrauce, 96.
 Williams, 61, 171.
 Turpin, Sir George, 31.
 Sibell = Villers, 31.
 Turvey, Alicia (Peck), 147.
 Thomas, 147.
Turville, 53, 55.
 TURVILLE, 53, 54, 55.
 Adam, 53.
 Agnes = Rowleston, 54.
 Ambrose, 55.
 Anne = Swillington, 55.
 Anne (Sheldon), 55.
 Anne (Cooke), 55.
 Anne (Martin), 55.
 Dorothy, 55.
 Elizabeth (Foulehurst), 54.
 Elizabeth = Bradbourne, 55.
 Elizabeth (Bradbourne), 55.
 Elizabeth = P, 55.
 Elizabeth (Bridges), 55.
 Elizabeth = Alcock, 55.
 Elizabeth (Stanton), 15.
 Ellin (Ferrers), 54.
 Ellin = Bickerton, 55.
 Ellin (Armestronge), 55.
 Francis, 54, 55.
 Frances, 55.
 Galfridus, 55.
 George, 55.
 Henry, 55.
 Hugh, 53, 54, 55.
 Jane (Babington), 55.
 Jane = Gunter, 55.
 Jane = Bate, 55.
 Jasper, 55.
 Joan (Warberton), 54.
 John, 38, 47, 54, 55.
 Katherin (Stanton), 54.
 Katherin, 55.
 Margaret, 55.
 Margaret (Bouge), 54.
 Margaret (Woodford), 38.
 Margeria = Malory, 55.

TURVILLE—*continued.*

- Margeria = Cleyton, 55.
 Margery (Woodfort), 47.
 Martha = Blunt, 55.
 Mary = Bradbourne, 54.
 Mary (Fendern), 54.
 Mary = Waldron, 55.
 Mary = Gill, 55.
 Mary = Marston, 101.
 Nicholas, 53, 54.
 Ralph, 53, 54, 55.
 Richard, 53, 54, 55.
 Robert, 55.
 Soward, 55.
 William, 15, 54, 55.
 — (Hinde), 55.
 — (Wright), 55.
 Twigden, John, 108.
 Elizab. = Cooke, 108.
 Twine, Dorothea (Maye), 180.
 Edward, 180.
- Ufflett, Ellin (Legard), 19.
 Umpton, Edward, 73.
 Dorothy (Wroughton), 26.
 Katherin (Hastings), 73.
 Urswick — = Agar, 52.
- Vaughan — = Wincoll, 156.
 Vaulx, Elianor = Humphrey, 62.
 Elizabeth (Beaumont), 60, 172.
 Sir William, 62.
 William, Lord, 172.
 Vaux, Ellin = Brookesby, 49.
 William, Lord, 49, 60.
 Vavasour, Elizabeth (Peck), 147.
 Katherin = Peck, 147.
 Ralph, 147.
 William, 147.
 Veal, Elianora = Burdet, 23.
 John, 23.
 Robert, 23.
 Venables, Alicia = Danvers, 86.
 Anne = Brooke, 65.
 Modevina (Smalley), 76.
 Vernam, Elizab. (Digby), 199.
 Humphrey, 199.
 Marg^t = Dawes, 98.
 Vernon, George, 73.
 Matilda (Longford), 73.
 Vichan, Agatha = Bellers, 29.
 Sir Richard, 29.
Villers, 29.
- VILLERS, 29, 30, 31.
 Agnes (Digby), 30.
 Alexander, 29.
 Anne = Rigden, 31.
 Anne (Finnes), 30.
 Anthonie, 31.
 Audry (Saunders), 30.
 Barbara (St John), 30.
 Bartholmew, 30, 51.
 Blase, 30.
 Blast', 31.
 Christopher, 30.
 Clement, 31.
 Dorothy, 31.

VILLERS—*continued.*

- Edward, 31.
 Elizabeth (—?—), 29.
 Elizabeth (Southwell), 30.
 Elizabeth = Butler, 30.
 Elizabeth (Wake), 31.
 Elizabeth (Winger), 31.
 Elizabeth = Waterhouse, 31.
 Elizabeth (Lane), 31.
 Elizabeth = Chambers, 51.
 Francis, 29, 30.
 Francis [L^d Villers], 31.
 George, 31, 171.
 George [D. of Buckingham], 31.
 Jane (Harington), 31.
 Janne (Saunders), 31.
 Joane (Symon), 29.
 Joane (Bellers), 30.
 Joan (Roos), 31.
 John, 29, 30, 31, 180.
 Katherin (Manners), 30.
 Leonard Anthonie, 30.
 Margaret = Fuljambe, 29.
 Margaret = Cotton, 191.
 Margeria (Stanton), 15.
 Martha = Savill, 93.
 Mary (Beaumont), 30, 60, 171.
 Mary = Stuard [D. of Lennox], 31.
 Richard, 29, 31.
 Robert, 29, 31.
 Sibell (Turpin), 31.
 Sir Edward, 30.
 Sir George, 29, 60.
 Sir George [Mq^s of Buckingham], 30.
 Sir John, 30.
 Sir William, 30.
 Susan = Feilding, 30.
 Thomas, 30.
 William, 29, 30, 31.
 Winifred, 30.
 — (Cooke), 30.
 — (Griffin), 30.
 — = Gee, 180.
 — = Browne, 31.
- Vincent*, 50.
 VINCENT, 50, 51, 79, 80, 81, 82.
 Alicia (Grimsby), 59.
 Alicia (Abell), 79.
 Alicia (Faunt), 81.
 Alicia (Withe), 81.
 Amy (Coles), 80.
 Anne, 79, 81, 82.
 Anne (Storrey), 46, 50.
 Anne (Grimsby), 50, 80.
 Anna = Clerke, 79.
 Anthony, 50, 81.
 Brian, 51, 81.
 Clement, 51, 81.
 Dorothea, 79.
 Edward, 51, 81, 82, 206.
 Elizabeth = Middleton, 79.
 Elizabeth (Harvy), 79.
 Elizabeth = Mason, 81.
 Elizabeth = Temple, 167.
 Elinora = Sewell, 81.
 Elinor = Hall, 81, 82.

VINCENT—*continued.*

- Emma, 79.
 Francis, 51, 81, 82.
 Francisca (Baker), 79.
 George, 28, 34, 46, 50, 51, 80, 81, 82, 99.
 Gilbert, 51, 81.
 Jane = Faunt, 28.
 Jane = Cave, 50, 80.
 Jane = Purifoy, 50, 81.
 „ = Faunt, 50, 81.
 Jane = Wright, 51, 81, 82, 152.
 Jane (Soltey *vel* Storey), 80.
 Joan = Purifoy, 34.
 „ = Faunt, 34.
 Jocosa = Kisse, 79.
 Johanna (Sturgis), 79.
 John, 79.
 Katherina = Barker, 81.
 Katherin, 81.
 Margaret (Babington), 51, 81.
 Margaret (Huet), 79.
 Margaret = Mowslesley, 79.
 Margeria (Babington), 82, 206.
 Maria = Staesmore, 51, 81, 99.
 Maria (Bury), 79.
 Maria (Abney), 81.
 Maria (Salisberie), 81.
 Marmaduke, 51, 81, 82.
 Mary (Tanfeild), 81.
 Mary (Forman), 81.
 Mary (Brokesby), 81.
 Maria, 81.
 Michael, 81, 82.
 Nicholas, 50, 51, 81, 82.
 Peter, 50, 80.
 Phillip, 50, 80.
 Richard, 12, 50, 59, 79, 80, 81, 167.
 Robert, 50, 79, 81.
 Sabine, 81.
 Sara, 81.
 Susanna, 79.
 Thomas, 28, 50, 51, 81, 82.
 Ursula, 81.
 William, 79, 81, 82, 124.
 — (Barnard), 50.
 — (Eyre), 50.
 — (Salisbury), 50.
 — (Forman), 50.
 — (Coles), 50.
 — (Tanfeild), 51.
 — (Abney), 51.
 — (Vincent), 51, 81, 82.
 — (Snowsdale), 81, 82.
 — (Brokesby), 82.
 — (Yorksheir), 80.
 — (Wallis), 80.
 — = Lane, 51.
 — = Duport, 124.
- Vough (or Vowe) Agneta, 194.
 Agneta = Blocksome, 194.
 Agnitia (Dickingson), 194.
 Elizabeth, 194.
 Francis, 194.
 Francisca, 194.

Vough—*continued.*

Johanna, 194.
 Joeza, 194.
 John, 194.
 Leonard, 194.
 Lycia (Autwisell), 194.
 Margaret, 194.
 Margareta (Mitton), 194.
 Thomas, 194.
 Thomazin (Fisher), 194.
 William, 194.
 VOWE (or Vough), 194.
Vullis, 50.

Wade, Christopher, 188.
 Elizabetha = Gregorie, 188.

Wadham — = Yarde, 91.
 Waitt, Thomas, 16.
 Anne (Heselrigg), 16.

Wake, Elizabeth = Villers, 31.
 Isabella = Cave, 127.
 John, 200.
 Margareta = Brookesby, 200.

Wakefeild, Dorothy = Runding, 104.
 John, 57, 104.
 Mary (Burton), 57.

Walcot, Beatrix = Digby, 41.
 Beatrix = Dive, 41.
 Christiana (Ward), 83.
 John de, 83.

Walcott, Alicia = Huband, 86.
 „ = Barber, 86.
 „ = Shepey, 86.
 Anne (Brookesby), 49.
 Elizabeth (Walleis), 86.
 Margaret = Danvers, 86.
 William, 86.

Waldeshof, Mary = Shirley, 25.
 William, 25.

Waldif, Agnes = Burdet, 24.
 John, 24.

Waldron, Katherin = Bickerton, 173.
 Mary (Turvile), 55.

Walkden, Johanna = Dixy, 116.

WALKER, 137.
 Albania (Walker), 137.
 Elizabeth (Brooke), 65.
 Elizabeth (Henson), 137.
 George, 137.
 Jocosa = Smalley, 77:
 John, 157.
 Katherin (Chippingdale), 157.
 Maria (Buckby), 137.
 Richard, 55, 77, 137.
 Rowland, 137.
 William, 137.

Walleis, John, 86.
 Elizabeth = Walcott, 86.
 „ = Bisphane, 86.
 Robert, 86.

Waller — = Sherman, 203.

Walleys, Weles *vel*, 40.

Wallis — = Vincent, 89.

Wallop, Henry, 177.

Wallop—*continued.*

Eliz. (Corbet), 177.
Walshall, 5.

Walshall, Eliz. = Staresmore, 5, 99.
 Katherin = Ringley, 5.
 Maria = Wilkes, 5.
 Robert, 5, 99.
 Sir William, 5.
 — (Peirpoint), 5.

Walton, Agnes de = Shirley, 25.
 Elizabeth = Bent, 91, 159.
 „ = Yarde, 91.
 Simon de, 25.
 Thomas, 91.

Warborton, Joan = Turvile, 54.
 Sir John, 54.

Ward or *Warde*, 83, 87.

WARD or WARDE, 83, 87.
 Alicia (Barton), 83.
 Alexander, 83.
 Alicia, 83.
 Amicia = Coles, 83.
 Anna (Cheselden), 83.
 Anna = Cotes, 94.
 Anna = Hodgis, 83, 154.
 Anna = Cave, 125.
 Anne (Gerveis), 71.
 Christiana = Walcot, 83.
 Dorothea, 87.
 Edward, 71.
 Elizabeth, 83.
 Elizabeth (Ashby), 83.
 Elizabeth = Salisberie, 186.
 Elizabeth = Allen, 83.
 Elizabeth (Bent), 159.
 Felicia (Frisby), 83.
 Francisca, 83.
 George, 83.
 Isabella = Woodward, 83.
 Jacobus, 83.
 Jane (White), 83.
 Johanna = Aston, 83, 199.
 Johanna = Capet, 83.
 John, 83, 94, 186.
 Katherin = Gerveis, 71.
 Margaret = Roos, 92.
 Margaret = Dansy, 83.
 Martha (Lancaster), 83, 87.
 Maria, 83.
 Maria (Halton), 83.
 Petromilla (Bent), 158.
 Robert, 83.
 Sir Simon, 125.
 Theobaldus, 83.
 Thomas, 83, 87.
 William, 83, 92, 154, 158, 159, 199.
 — (Allen), 83.
 — (Chamberlaine), 83.
 — = Nevill, 22.
 — (Weston), 83.

Warde alias *Farmour*, 177.

WARDE alias FARMOUR, 177, 178.
 Gracia (Grey), 139, 178.
 Henry, 178.
 James, 139, 177, 178.
 Joseph, 178.
 Katherin, 178.

WARDE alias FARMOUR.—*cont.*

Katherina (Abney), 177.
 Laurence, 177.
 Maria = Dilke, 178.
 Thomas, 177, 178.
 William, 177.
 — (Smith), 177.

Warner, John, 105.
 Isabella = Alsop, 105.
 — = Brudnell, 143.

Wase, 200.

WASE, 200.
 Alicia, 200.
 Alicia (Bailey), 200.
 Anna, 200.
 Anna (Colecough), 200.
 Anna (Widder), 200.
 Anna = Allen, 200.
 Dorothea, 200.
 Edward, 200.
 Elizabeth (Meverell), 200.
 Elizabeth = Olife, 200.
 „ = Armestronge, 200.
 Ellianor, 200.
 George, 200.
 Jane, 200.
 Jane (Darker), 200.
 John, 200.
 Katherine, 200.
 Margareta, 200.
 Margareta (Wildman), 200.
 Margaret = Fox, 200.
 Margeria (Brokesby), 200.
 Richard, 200.
 Samson, 200.
 Susan, 200.
 Thomas, 200.
 Valentine, 200.
 William, 200.

Waterhouse, Edward, 31.
 Elizabeth (Villers), 31.

Waterton, 2, 12.

Waterton, Anne (Grimsbey), 12, 50, 80.
 Jane = Everard, 12, 50, 80.
 Richard, 12, 50, 80.

Watkin, John, 108.
 Katherin, Cooke, 108.

Watson, Dorothea (Needham), 100.
 Ezichia, 100.
 Susan = Ruding, 104.

Wattes, Agneta (Noble), 115.
 Margareta (Noble), 115.
 Maria (Noble), 115.
 Richard, 115.
 Thomas, 115.
 William, 115.
 — (Bradshawe), 44.

Watts, Elizab. (Everard), 175.
 John, 191.
 Maria = Bainbrig, 191.
 Stafford, 175.

Waynman, Richard, 36.
 — = Purifoy, 36.

Webb, John, 182.
 Lucia = Lawde, 182.
 „ = Robinson, 182.

Webbe, Bennet (Draper), 52.
 Sir William, 52.

Webster, Anna (Everard), 142.

- Webster—*continued*.
 Richard, 142.
 William, 114.
 — = Noble, 114.
 Wedgwood, Jane (Heserlrigg), 16.
 John, 16.
 — = Meade, 151.
 Weles [or Walleys], Alicia = Digby, 40.
 John, 40.
Welles, 2.
 Welles, Alicia (Wilcocks), 136.
 Ralph, 136.
 Wellesborough, Adam, 32.
 John, 32.
 Katherin = Purifoy, 32.
 Ralph, 32.
 Richard, 32.
 Robert, 32.
 Thomas, 32.
 William, 32.
 Wellock, George, 189.
 Sara (Gilbert), 189.
 Wells, Lionel Lord, 2.
 Welsh, John, 148.
 Elizabeth = Alsop, 105.
 Elizabeth = Whalley, 148.
 Wenle, Mary = Purifoy, 32.
 Sir Henry, 32.
 Westmoreland, E. of [Nevill], 21.
 Weston, Ann = Feilding, 31.
 Hugo, 151.
 Jeronimus, 126.
 Jocosa (Meade), 151.
 John, 192.
 Maria (Caldwall), 192.
 Maria (Cave), 126.
 — = Ward, 83.
 [E. of Portland], 31.
 Westwood, Ann (Bainbrig), 191.
 Humphrey, 191.
Whalley, 148.
WHALLEY [or **WHALY** or **WHALEY**], 148.
 Dorothea = Abbot, 148.
 Elizabeth (Welsh), 148.
 Elizabeth (Glossop), 148.
 Elizabeth = Fisher, 148.
 Elizabeth = Garton, 148.
 Elizabeth = Goodman, 84.
 Francisca = Whaley, 148.
 Francisca = Bushby, 148.
 Galfridus, 148.
 Jana, 148.
 Margareta (Coke), 184.
 Margareta = Bromley, 148.
 Maria = Norris, 148.
 Milicent (Saunders), 148.
 Rachel, 148.
 Ralph, 84, 148.
 Robert, 148.
 Thomas, 148.
 William, 84, 148.
 Whatley, Isabell = Brasbridge, 43.
 Laurence, 43.
 Whatton, George, 193.
 Margaret = Farnham, 77.
 Whatton—*continued*.
 Robert, 77.
 — = Eyre, 193.
 Wheathill, John, 45.
Wheatley, 51.
 Wheatley, Elizabeth (—?)—, 51.
 John, 51.
 Symon, 45.
 Thomazin = Darnet, 51.
 William, 51.
 Wheler, Ellen (Digby), 41.
 Whetell, Elizab. = Purifoy, 34.
 Thomas, 34.
Whethill, 44.
WHETHILL, 44, 45.
 Anna (Bradshaw), 44, 45.
 Anna = Bostock, 45.
 „ = Cowper, 45.
 „ = Mountney, 45.
 Christian, 45.
 Dorothy = Norwood, 45.
 Elizabeth = Purifoy, 45.
 John, 44, 45.
 Margaret (Flandus), 44.
 Richard, 44, 45.
 Simon, 44, 45.
 Thomas, 44, 45.
 William, 45.
 — (Billing), 45.
 — = Goslinge, 45.
 — (Norton), 45.
 — (Wriothesley), 45.
WHITAPH, 98.
 Alicia, 98.
 Anna = Mussen, 98.
 Anna (Sacheverell), 98.
 Margareta (Catiell), 98.
 Maria, 98.
 Maria = Stevens, 98.
 Rachell, 98.
 Thomas, 98.
 William, 98.
 Whitby, John, 184.
 Susanna = Hollingsworth, 184.
 Whitchestell — = Peche, 65.
 Whithill, Jocosa = Mountney, 179.
 Thomas, 179.
Whiting, 92.
WHITING, 92.
 Abigall = Burton, 92.
 Anna, 92.
 Dorcas, 92.
 Elizabeth, 92.
 Elizabeth (Heath), 92.
 Francisca (Bunning), 92.
 Giles, 92.
 John, 92.
 Maria, 92.
 Maria (Carew), 92.
 Martha, 92.
 Martha = Nethercote, 92.
 Nathaniell, 92.
 Robert, 92.
 Sara = Lambe, 92.
 Timotheus, 92.
 — (Bunning), 92.
 — (Shipham), 92.
 — (Thurgood), 92.
 Whittington — = Everard, 13.
 White, Elizabeth (Baghot), 155.
 Elizabeth (Starismore), 99.
 Francis, 99, 151.
 Jane = Warde, 83.
 John, 83, 128.
 Margaret (Baghot), 151.
 Maria = Cave, 128.
 Richard, 151.
 Whitney, Anne (Brooke), 65.
 Thomas, 65.
 Whitton, Elizabeth = Robertes, 117.
 Margeria = Thame, 130.
 Thomas, 130.
 Whitworth, Elizabeth = Legard, 19.
 John, 19.
Wigmall, 70.
 Widder, Ann (Wase), 200.
 William, 200.
 Wigbett, Anne (Peck), 147.
 William, 147.
 Wightman, Dorothea (Croft), 141.
 Francisca = Salisberie, 185.
 Katherin (Purifoy), 37.
 Thomas, 37, 141.
Wigley, 97.
WIGLEY, 97.
 Alicia = Deane, 97.
 Anna (Russell), 97.
 Anna (Spell), 97.
 Edward, 97.
 Elizabeth (Blackwall), 97.
 Ellena = Shorte, 97.
 Ellena (Orme), 97.
 Emma = Carick, 97.
 Emma (Plant), 97.
 Francis, 97.
 George, 97.
 Goditha (Gill), 97.
 Henry, 97.
 Jane = Allen, 97.
 John, 97.
 Katherina (Colborne), 97.
 Margaret (Stevenson), 97.
 Thomas, 97.
 — (Bunting), 97.
 — (Curson), 97.
 — (Gell), 97.
 Wigston, Katherin = Purifoy, 37.
 Sir William, 37.
 Wikeman — = Farmer, 179.
WILCOCKES, 135, 136.
 Alicia = Welles, 136.
 Anna = Malson, 136.
 Dorothea, 136.
 Edward, 136.
 Elizabeth = Lacy, 166.
 Galfridus, 135, 136.
 Margeria (Nowers), 136.
 Maria (Rosse), 136.
 Maria = Rudkin, 136.
 Maria (Woode), 135.
 Richard, 136, 166.
 Robert, 135, 136.
 Roger, 135, 136.
 Sense = Bell, 136.

- WILCOCKES—continued.**
 Susanna (Burton), 136.
 Thomas, 135, 136.
 William, 135, 136.
Wilcock — = Needham, 100.
Wildman, Erasmus, 200.
 Margaret = Wase, 200.
Wilkes, Margaret (Smith), 66.
Willes, Agnes (Legard), 19.
 Maria (Walshall), 5.
 Sir Thomas, 66.
Williams, Christian = Har-
 top, 9, 196.
 David, 15.
 Elizabeth = Purifoy, 35.
 Herald (Heslerigg), 15.
 John, 9, 196.
 Reinold, 35.
 — = Bickerton, 173.
Willington, Joyce (Winter),
 42.
 Margareta = Cave, 126.
 Margery (Brasbridge), 43.
 William, 126.
Willmer, Alicia = Bent, 158.
Willmet, Maria = Bainbrig,
 191.
 Robert, 191.
Willnes, Dorothy (Burton),
 57.
Willoughby, Alicia = Pochin,
 106.
 Anna (Lincolne), 106.
 Elinor = Shirley, 26.
 Elizabeth = Beaumont, 169.
 Francis, 73.
 Hugo, 68, 78, 96.
 Margaret = Belgrave, 68,
 96.
 Phyllippa = Harvy, 59, 140.
 " = Motton, 59.
 Sir Hugh, 26.
 William, 106.
 William, Lord, 169.
 — = Hastings, 73.
Wilne, John, 109.
Wilson, Agnes (Winter), 24.
 Joyce = Brasbridge, 43.
 Mary = Burdet, 24.
 Thomas, 24, 43.
 — = Belgrave, 69.
Wilston, Alice = Cheselden,
 20.
 Roger, 20.
Wimark, Ann = Corbet, 17.
Winchester, E. of [Quincey]
 86.
Wincoll, 156.
WINCOLL—continued.
 Alicia = Spencer, 156.
 Anna = Holliday, 156.
 " = Montague, 156.
 Anna (Gourdon), 156.
 Anna (Bower), 156.
 Anna (Crouch), 156.
 Elizabeth, 156.
 John, 156.
 Margaret = Spencer, 156.
 Maria, 156.
 Maria = Hudeson, 156.
 Richard, 156.
WINCOLL—continued.
 Robert, 156.
 Roger, 156.
 Susanna (Madock), 156.
 Thomas, 156.
 William, 156.
 — (Bantock), 156.
 — (Chaplin), 156.
 — (Syday), 156.
 — (Vaughan), 156.
 — = Cage, 156.
Windsor, Anna = Corbet,
 177.
 Anna = Gray, 75.
 Anna = Purifoy, 33, 36.
 Thomas, 33, 36.
 William, Lord, 75.
Winger, Elizabeth = Villers,
 31.
 John, 31.
Winter, 42.
WINTER, 42.
 Agnes = Brooke, 24.
 " = Wilson, 24.
 Anne (Hardwick), 42.
 Anne = Bowles, 42.
 Anna = Winter, 42.
 Anna (Staresmore), 6.
 Ciceley = Stockey, 42.
 Cicilia = Starkie, 175.
 Edward, 42.
 Elizabeth = Bradbridge, 42,
 43.
 " = Crewker, 42,
 43.
 George, 42, 43.
 Henry, 42.
 Joyce = Willington, 42.
 Katherine (Grisley), 42.
 Mary = Baskerville, 42.
 Robert, 42.
 Thomas, 175.
 — (English), 175.
 — (Farrent), 202.
Wirley, Augustine, 123.
 Elizabeth (Cave), 126.
 Katherin (Charnells), 123.
 William, 123, 126.
Wiseman, Dorothea =
 Brookesbey, 49.
 William, 49.
Wistowe, Joane = Purifoy,
 33.
Withe, Alice = Vincent, 81.
Witterantes — = Ashby, 14.
Wiveston, Alicia = Noel, 113.
 Henry de, 113.
Wodford, 10.
Wodham — = Whetworth, 19.
Wodhul, Mary (Rodney), 24.
 Thomas, 24.
Wolbeck — = Staresmore, 6.
Wolfe, 5.
Wollesborow, Adam, 32.
Wolowe, Alicia = Bothom,
 165.
 Roger, 165.
Wolverston, Margt = Eve-
 rard, 142.
 Thomas, 142.
Wolveston, Margt = Eve-
 rard, 12.
Wolveston—continued.
 Thomas, 12.
Wood, Edward, 16.
 Frances (Heslerigg), 16.
Woodcock — = Smith, 66.
Woode, Beatrix (Danvers), 98.
 Elizabeth = Prestwich, 63.
 Maria (Wilcocks), 136.
 Robert, 136.
 Thomas, 98.
 — = Smith, 131, 136.
WOODFORD et TURVILL,
 38.
WOODFORD, BRABASON
 et, 47.
 Anna (Norwich), 38, 47.
 Jane (Brabson), 47.
 Johanna, 38.
 John, 38, 47.
 Lucy (Brokesby), 38.
 Mabill (Folville), 47.
 Margareta = Morton, 47,
 131.
 Margaret = Turvill, 38
 [*us*].
 Margery = Turvill, 47.
 Mathew, 38.
 Radulphus, 38.
 Ralph, 47.
 Robert, 38.
 Sir Robert, 47.
 Thomas, 38, 47, 181.
 William, 38, 47, 131.
 — = Barnack, 38.
 — (Markham), 38.
 — = Sherard, 10.
Woodlake — (Everard), 13.
Woodroffe, Briget (Draper),
 52.
 Stephen, 52.
Woodvile, 10.
Woodvile, Anna = Grey, 139.
 Anna = Bouchier, 139.
 Elizabeth = Grey, 74.
 " = King Edward
 IV., 74.
 Richard [E. Rivers], 74,
 139.
Woodward, Bartholemew, 83.
 Isabella (Ward), 83.
Worcester, E. of [Somerset],
 73.
Worship — = Robertes, 117.
Worshipp — = Staresmore, 6.
Worthington, Jana (Peper),
 103.
Wotton, Hester = Noell, 4.
 Lord Edward, 4.
 Margaret = Grey, 74.
 " = Medley, 74.
 Robert, 74.
Wrenne, Anne (Dalton), 27.
 Thomas, 27.
WRIGHT, 152.
 Alicia = Breton, 152, 161.
 Alicia (Maye), 180.
 Christopher, 37.
 Edward, 152.
 Elizabeth = Laurence, 102.
 Elizabeth (Roberts), 118.
 Jana (Vincent), 51, 81, 82,
 152.

WRIGHT—*continued.*

Jane (Purifoy), 37.
 Katherina, 152.
 Katherina (Guest), 152.
 Margaret (Staresmore), 6.
 Maria, 152.
 Maria (Berrey), 152.
 Richard, 152, 161.
 Robert, 51, 81, 82, 152.
 Roger, 152.
 Samuell, 152.
 Susanna (Croft), 141.
 Thomas, 141, 152, 180.
 William, 118, 152.
 Winifride, 152.
 — (Broadgate), 152.
 — = Salisbury, 185.
 — = Turvile, 55.
 Wriothsley — = Whethill, 45.
 Wroughton, Dorothy =
 Shirley, 26.

Wroughton—*continued.*

Dorothy = Umpton, 26.
 Wydowes, Alicia = Temple,
 168.
 Wye — (Baiard), 66.
 Wymark, Anne = Corbet, 48.
 Jane = Noone, 174.
 — = Brudnell, 143.
 Wyndover, Elizabeth (Robertes), 203.
 Yarde, 91.
 YARDE, 91.
 Agnis (Stroude), 91.
 Edward, 91.
 Elizabeth (Luson), 91.
 Elizabeth (Walton), 91.
 Elizabeth = Herick, 91.
 Elinora = Cotes, 91, 94.
 Gilbert, 91.
 Johanna (Hurst), 91.

YARDE—*continued.*

Margareta (Bamfeild), 91.
 Margeria = Hill, 91.
 Roger, 91.
 Thomas, 91.
 William, 91, 94.
 Yate, Francisca = Morton,
 184.
 Richard, 184.
 Yaxley, Katherin = Lany,
 196.
 — = Sherman, 203.
 Yore — = Beaumont, 172.
 Yorksheir — = Vincent, 80.
 — = Hatfeild, 80.
 Young — = Cotton, 191.
 Zouch, Edward, L^d, 73.
 Lady Eva le = Berkley, 2.
 Lord le, 2.
 Sara (Harington), 73.

The Harleian Society,

INSTITUTED FOR THE

PUBLICATION OF INEDITED MANUSCRIPTS

RELATING TO

GENEALOGY, FAMILY HISTORY, AND HERALDRY.

President.

HIS GRACE THE DUKE OF MANCHESTER.

Vice-Presidents.

THE RIGHT HON. LORD MONSON.
THE HON. WILLIAM BRODRICK, M.P.
THE HON. HENRY ROPER-CURZON.
SIR GEORGE F. DUCKETT; BART., F.S.A.
SIR HENRY VAVASOUR, BART.
SIR JOSEPH RADCLIFFE, BART.
RALPH ASSHETON, Esq., M.P.
EVELYN PHILIP SHIRLEY, Esq., F.S.A.
R. E. EGERTON-WARBURTON, Esq.

Council.

W. AMHURST TYSSEN AMHURST, Esq.
GEORGE W. MARSHALL, Esq.
GRANVILLE LEVESON GOWER, Esq., F.S.A.
JOSEPH JACKSON HOWARD, Esq., LL.D., F.S.A., *Hon. Treasurer.*
THE REV. SAMUEL HAYMAN, M.A.
GEORGE J. ARMYTAGE, Esq., F.S.A., *Hon. Secretary.*
COLONEL JOSEPH LEMUEL CHESTER.
JOHN DAVIDSON, Esq.
JOHN MACLEAN, Esq., F.S.A.
WENTWORTH STURGEON, Esq.
JOHN FETHERSTON, Esq., F.S.A.
FAIRLESS BARBER, Esq., F.S.A.

Bankers.

LONDON AND COUNTY, 21, Lombard Street.

Auditors.

LIONEL G. ROBINSON, Esq., Junior Athenæum Club, and
Audit and Exchequer Office.
DUDLEY CARY ELWES, Esq., F.S.A., South Bersted, Bognor.

Rules.

1. This Society shall be called the HARLEIAN SOCIETY.
2. It shall have for its chief object the publication of the Heraldic Visitations of Counties, and any manuscripts relating to genealogy, family history, and heraldry, selected by the Council.
3. The Council shall consist of a President, nine Vice-Presidents, and twelve Members of Council, two of whom shall hold the posts of Secretary and Treasurer; and any four, including the Treasurer or Secretary, shall form a quorum. In case of equality of votes, the Chairman to have a casting vote. Any Candidate may be elected with the consent in writing of one Member of the Council, the Treasurer, and the Secretary.
4. Three Members of the Council shall retire in rotation annually, but shall be eligible for re-election.
5. The Annual Subscription shall be One Guinea, paid in advance, and due on the 1st day of January in each year; and Members elected after two hundred and fifty shall have joined, shall pay an Entrance Fee of 10s. 6d. in addition to their first Annual Subscription.
6. The funds raised by the Society shall be expended in publishing such works as are selected by the Council.
7. One volume at least shall be supplied to the Members every year.
8. An Annual Meeting shall be held in the month of June every year, at such time and place as the Council may direct; and due notice shall be sent to the Members of the Society at least a fortnight previously.
9. No work shall be supplied to any Member unless his Subscription for the year be paid; and any member not having paid his subscription for two years, having received notice thereof, shall cease to belong to the Society.
10. The Council may, at their discretion, pay the expense of transcribing from manuscripts whenever two hundred Members, at least, shall have joined the Society; but no payment in money shall be made to any person for editing any work for the Society.
11. No copies of the Publications of the Society shall be supplied to persons not actually Members, and each Member shall be restricted to a single Subscription.
12. An account of the receipts and expenses of the Society to be made up to the 1st of June in each year, and published with a list of the Members and the Rules of the Society in the following volume.
13. These Rules shall not be altered except at the Annual Meeting, and three clear weeks' notice must be given to the Secretary of any such intended alteration.

The Council have selected the Visitation of Rutland in 1618 to follow that of Leicestershire.

Report for the Year 1869-70.

ON the 27th of March, 1869, two Members of the Society's Council invited several of their friends and correspondents to assist in the formation of a Society, having for its special object the publication of the *Heralds' Visitations of Counties and other important Genealogical Manuscripts*. By the 28th of May, fifty-eight persons signified their willingness to co-operate in the establishment of such a Society, and at a Special Meeting held on that day at 8, Danes Inn, the Honourable HENRY ROPER-CURZON in the Chair, the Officers of the Society were appointed and the Rules drawn out. The success that the Society met with was so great, that by the 28th of July no fewer than one hundred Members had joined, and from that time to the present this number has been gradually increasing, so that now it exceeds one hundred and seventy Members.

This great success may be attributed to the exertions of the several Members of the Council, and to the literary status of many of the original Members.

The Society has already published and distributed 'The Heraldic Visitation of London, taken by Robert Cooke, Clarenceux, in 1568,' edited by JOSEPH JACKSON HOWARD, F.S.A., and GEORGE J. ARMYTAGE, F.S.A.

Camden's 'Visitation of Leicestershire in 1619,' edited by JOHN FETHERSTON, F.S.A., will be ready for circulation in about a fortnight. This is a large work, and contains 207 pages of pedigree matter only. It will also include facsimiles of several of the signatures of the heads of families who entered their pedigrees at that Visitation, together with a very elaborate armorial and general index.

Sir GEORGE F. DUCKETT, Bart., F.S.A., has offered to edit a Visitation for the Society; and the 'Visitation of Nottingham,' to be edited by G. W. MARSHALL, Esq., LL.M., is ready for the press; and the three Oxfordshire Visitations are now being prepared by Mr. WILLIAM HENRY TURNER, of Oxford.

The Society is now in a position to print Two Volumes a year, and it is hoped that the addition of another hundred Members will enable a third volume to be published; and it is believed that the issue of Three Volumes in return for the Guinea Subscription will place the Society in the foremost ranks of such Associations of this country.

The especial thanks of the Members are due to the Council of the Surrey Archæological Society for so courteously placing their Meeting-room at the disposal of the Harleian Council. Arrangements are now being made for the payment of a few pounds per annum to the Surrey Society, as it is considered desirable that this Society shall have a recognized place of meeting.

List of Members,

CORRECTED TO JUNE 22ND, 1870.

G. BRINDLEY ACWORTH, F.S.A., Star Hill, Rochester.
 EDWARD AKROYD, M.P., F.S.A., Bank Field, Halifax.
 REGINALD AMES, Cote House, Westbury-on-Trym, Bristol.
 W. AMHURST T. AMHURST (*Council*), Diddington Hall, Brandon.
 FRANK ANDREW, Ashton-under-Lyne.
 ELY ANDREW, Mere Bank, Ashton-under-Lyne.
 J. E. ANDREWES, War Office.
 CHARLES FREDERICK ANGELL, F.S.A., Grove Lane, Camberwell, S.E.
 FRANCIS R. ARMYTAGE, Balliol College, Oxford.
 GEORGE J. ARMYTAGE, F.S.A. (*Hon. Secretary*), Kirklees Park, Brighouse.
 THE EARL OF ARRAN, The Pavilion, Hans Place, S.W.
 RALPH ASSHETON, M.P. (*Vice-President*), Downham Hall, Clitheroe.
 REV. CHARLES S. ATKINSON, Harswell, York.
 W. J. ST. AUBYN, 68th Light Infantry, Fort Camden, Cork.
 CHARLES BAKER, F.S.A., 11, Sackville Street, Piccadilly, W.
 MRS. BAKER, Ulster Terrace, Regent's Park, N.W.
 FAIRLESS BARBER, F.S.A. (*Council*), Castle Hill, Rastrick, near Brighouse.
 JOSEPH GURNEY BARCLAY, 54, Lombard Street, E.C.
 THOMAS H. BATES, Mayfield, Wolsingham.
 GEORGE FREDERICK BEAUMONT, Knowle, Fixby, Huddersfield.
 REV. CHARLES W. BOASE, 33, Surrey Street, Strand, W.C.
 W. CONSITT BOULTER, F.S.A., 6, Park Row, Park Street, Hull.
 EDMUND M. BOYLE, Rockwood, Torquay.
 Lieut.-Col. BRADBURY, Huddersfield,
 The Rev. WILLIAM BREE, the Rectory, Allesley, Coventry.
 The Hon. and Rev. R. O. BRIDGEMAN, Weston-under-Lyziard, Shifnal.
 The Hon. WILLIAM BRODRICK, M.P. (*Vice-President*), 20, Beaufort Gardens, S.W.
 THOMAS BROOKE, Armitage Bridge, Huddersfield.
 FRANCIS CAPPER BROOKE, Ufford Place, Woodbridge.
 PERCY C. S. BRUERE, Middleham, Bedale, Yorkshire.
 The Rev. JOSEPH BUCKLEY, M.A., Sopworth Rectory, Chippenham.
 W. E. G. LYTTON BULWER, Quebec House, East Dereham.
 CHARLES JOHN BURGESS, Naval and Military Club, London, W.
 SIR BERNARD BURKE, C.B., LL.D., Ulster King-of-Arms, Dublin.
 The Dowager Countess of CARNARVON, Pixton Park, Dulverton.
 GEORGE ALFRED CARTHEW, F.S.A., East Dereham, Norfolk.
 COLONEL J. L. CHESTER (*Council*), 16, Linden Villas, Blue Anchor Road, Berrymondsey, S.E.
 Rev. FREDERIC T. COLBY, B.D., F.S.A., Fellow of Exeter College, Oxford.
 JAMES EDWIN COLE, Easthorpe Court, Wigtoft, Spalding.
 F. S. BIRMINGHAM PEN COLE, Freemantle, Southampton.
 SYDNEY COLE, Norwood Court, Southall, Middlesex.
 JAMES COLEMAN, 22, High Street, Bloomsbury, W.C.
 W. H. COTTELL, 1, Manor Rise, Brixton, S.W.
 J. GREGORY COTTINGHAM, Edensor, Chesterfield.
 W. PRIDEAUX COURTNEY, Ecclesiastical Commission.
 MRS. JOHN WOODHEAD CROSSLAND, Thornton Lodge, Huddersfield.
 EDWIN PURVES ROPER-CURZON, Upper Sheen House, Mortlake, S.W.
 The Hon. HENRY ROPER-CURZON (*Vice-President*), 47, Argyle Road, Kensington.
 The Hon. SIDNEY C. ROPER-CURZON, Upper Sheen House, Mortlake, S.W.
 R. S. LONGWORTH DAMES, M.A., 32, Upper Mount Street, Dublin.
 JOHN DAVIDSON (*Council*), 14, St. George's Place, Hyde Park Corner, S.W.
 ROBERT DAVIES, F.S.A., The Mount, York.
 GORDON DAYMAN, St. Giles's, Oxford.

MRS. FETHERSTON DILKE, Maxstoke Castle, Coleshill, Warwickshire.
 ROBERT DOWMAN, 'Manchester Guardian' Office, Manchester.
 HENRY HOLMAN DRAKE, LL.D., St. Austell, Cornwall.
 The Rev. The Count Dawson-Duffield, LL.D., Sephton Rectory, Liverpool.
 SIR GEORGE F. DUCKETT, Bart., F.S.A. (*Vice-President*), Fangfoss Hall, York.
 GEORGE F. DUNCOMBE, 17, St. Stephen's Road, Bayswater, W.
 ALBERT EDWARDS, Philadelphia.
 The Rev. Henry T. Ellacombe, M.A., F.S.A., Clyst St. George Rectory, Topsham, Devon.
 Wm. Smith Ellis, Hydecroft, Charlwood, Surrey.
 DUDLEY CARY ELWES, F.S.A., South Bersted, Bognor.
 V. CARY ELWES, Brigg, Lincolnshire.
 THOMAS FALCONER, one of the Judges of the County Courts, Usk, Monmouthshire.
 J. G. FANSHAW, Board of Trade, Whitehall, S.W.
 WILLIAM FENNELL, Wakefield.
 JOHN FETHERSTON, jun., F.S.A. (*Council*), High Street, Warwick.
 GEORGE FITZWILLIAMS, New York, U.S.A.
 EDWARD FITZWILLIAMS, Philadelphia, U.S.A.
 JOHN RIBTON GARSTIN, F.S.A., 21, Upper Merrion Street, Dublin.
 ARTHUR EDWARD GAYER, Q.C., LL.D., Dublin.
 JOSEPH GILLOW, jun., Winckley Square, Preston.
 GRANVILLE LEVESON GOWER, F.S.A. (*Council*), Titsey Park, Godstone.
 HENRY SYDNEY GRAZEBROOK, Stourbridge, Worcestershire.
 The Rev. Henry Thomas Griffith, B.A., North Walsham, Norfolk.
 GORDON GYLL, Remenham House, Wraysbury, Staines.
 EDWARD HAILSTONE, F.S.A., Horton Hall, Bradford, Yorkshire.
 The Rev. H. F. HALL, M.A., High Legh, Knutsford, Cheshire.
 LADY FRANCES VERNON-HARCOURT, The Homme, Weobly.
 WILLIAM HENRY HART, F.S.A., The White House, St. Peter's Lane, Canterbury.
 WILLIAM HARVEY, Hatfold Hall, Bedford.
 The Rev. Samuel Hayman, M.A. (*Council*), The Rectory, Doneraile, Ireland.
 LADY HEATHCOTE, Hursley Park, Winchester.
 THOMAS HELSBY, 41, Princess Street, Manchester.
 ROBERT HENDERSON, Bell House, Pitminster, Taunton.
 SPENCER HEREPATH, 15, Upper Phillimore Gardens, W.
 MISS FRANCIS MARGERY HEXT, Lostwithiel, Cornwall.
 JOHN HIRST, jun., Dobcross, Saddleworth.
 The Rev. C. W. HOLBECH, Farnborough, Banbury.
 DANIEL DEAN HOPKYN, F.S.A., Weycliffe, St. Catherine's, near Guildford.
 JOSEPH JACKSON HOWARD, LL.D., F.S.A. (*Hon. Treas.*), 3, Dartmouth Row, Blackheath, S.E.
 Rev. Edmund Jermy, B.A., Nettlecombe Rectory, Taunton.
 JOSEPH JONES, Abberley Hall, Stourport.
 W. STAVENHAGEN JONES, 2, Verulam Buildings, Gray's Inn, W.C.
 EDWARD B. JUPP, F.S.A., Carpenters' Hall, London Wall, E.C.
 The Rev. F. W. KITTERMASER, All Saints, Coventry.
 ARTHUR JOHN KNAPP, Llanforsh House, Clifton, Bristol.
 C. T. LANE, 3, Lombard Court, Lombard Street, London.
 ARTHUR LARKEN, 53, Manchester Street, Manchester Square, W.
 The Rev. F. G. LEE, D.C.L., F.S.A., 6, Lambeth Terrace, London, S.W.
 MRS. LITTLEDALE, 19, Queen's Gate Gardens, South Kensington.
 BEN. LOCKWOOD, Huddersfield.
 WILLIAM H. DYER LONGSTAFFE, F.S.A., Gateshead.
 JOHN MACLEAN, F.S.A. (*Council*), Pallingswick Lodge, Hammersmith, W.
 SILVANUS J. MACY, 21, West 47th Street, New York, U.S.A.
 THE DUKE OF MANCHESTER (*President*), 1, Great Stanhope Street, W.
 GEORGE W. MARSHALL, L.L.M. (*Council*), Weacombe House, Bicknoller, Taunton.
 BERNULF DE CLEGG MATTINSON, Oldham.
 WALTER C. METCALFE, Epping, Essex.
 Captain R. MOLESWORTH, High Legh, Knutsford.
 The Right Hon. Lord Monson (*Vice-President*), Gatton Park, Reigate.
 THOMAS H. MONTGOMERY, 400, Walnut Street, Philadelphia, U.S.A.

Lieut.-Col. CHARLES THOMAS JOHN MOORE, F.S.A., Frampton Hall, near Boston.
 FREDERICK J. MORRELL, St. Giles, Oxford.
 EDWARD MORTON, The Villa, Malton, Yorkshire.
 GEORGE MURRAY, Hartford House, Werneth, Oldham.
 MISS NEWMAN, 6, Patshull Road, Kentish Town, N.W.
 MISS CHARLOTTE NEWMAN, 6, Patshull Road, Kentish Town, N.W.
 JAMES NEWMAN, 235, High Holborn, W.C.
 CAPTAIN W. NEWSOME, R.E., Gravesend.
 JOHN GOUGH NICHOLS, F.S.A., 25, Parliament Street, S.W.
 WILLIAM JOHN O'DONNAN, LL.D., M.R.I.A., Foxcroft House, Portarlington.
 EVAN ORTNER, 3, St. James's Street, S.W.
 FREDERIC OUVRY, F.S.A., 12, Queen Anne Street, Cavendish Square.
 The Rev. FIELDING PALMER, Eastcliff, Chepstow.
 The Rev. J. T. PARKINSON, D.C.L., F.S.A., Ravendale, Grimsby.
 DANIEL PARSONS, Stuarts Lodge, Malvern.
 D. WILLIAMS PATERSON, Newark Valley, New York, U.S.A.
 EDWARD PEACOCK, F.S.A., Bottesford Manor, Brigg, Lincolnshire.
 Rev. A. J. PEARMAN, Rainham Vicarage, Sittingbourne.
 CHARLES GEORGE PERCEVAL, Passenham Manor, Stony Stratford.
 THOMAS A. PERRY, Bitham House, Leamington.
 LEMUEL POPE, Cambridge, Massachusetts, U.S.A.
 SIR JOSEPH RADCLIFFE, Bart. (*Vice-President*), Rudding Park, Wetherby.
 The Rev. CANON RAINE, York.
 ALEXANDER RIVINGTON, 27, Cleveland Gardens, Hyde Park, W.
 The Rev. C. J. ROBINSON, M.A., Norton Canon Vicarage, Weobly.
 The Rev. EDWARD ROGERS, M.A., Blachford, Ivy Bridge, Devon.
 R. COXWELL-ROGERS, F.S.A., Dowdeswell Court, Andoversford, Gloucester.
 The Rev. ROBERT ROE ROGERS, 104, Exmouth Street, Parkfield Terrace, Birkenhead.
 The ROYAL LIBRARY, Windsor Castle.
 Rev. DAVID ROYCE, The Vicarage, Lower Swell, Stow-on-the-Wold.
 JAMES RUSBY, 34, Manor Road, Wickham Park, Lewisham, S.E.
 The DUKE OF RUTLAND, K.G., Belvoir Castle, Grantham.
 EVELYN PHILIP SHRILEY, F.S.A. (*Vice-President*), Lower Eatington Park, Stratford-on-Avon.
 Rev. E. H. MAINWARING SLADEN, M.A., F.R.G.S., Alton Berners, Marlborough.
 J. S. SMALLFIELD, 32, University Street, W.C.
 CHARLES SOTHERAN, 81, Derby Street, Hulme, Manchester.
 CHARLES STEWART, Royal Artillery, Government House, Jersey.
 WENTWORTH STURGEON (*Council*), 25, Gloucester Place, Portman Square, W.
 JOHN SYKES, M.D., F.S.A., Doncaster.
 MISS CAROLINE C. THAYER, Boston, U.S.A.
 T. G. TOMKINS, Great Ouseburn, York.
 GEORGE D. TOMLINSON, Huddersfield.
 HENRY TREHERNE, Latymer House, Brook Green, W.
 GEORGE TUCK, New Road, Windsor.
 WM. HENRY TURNER, 8, Turl Street, Oxford.
 J. R. DANIEL TYSSSEN, F.S.A., 9, Lower Rock Gardens, Brighton.
 PHILIP TWELLS, M.A., Chase Side House, Enfield.
 SIR HENRY VAVASOUR, Bart. (*Vice-President*), Holton Hall, Halesworth.
 EDWARD WALTHAM, Stockwell, London, S.W.
 R. E. EGERTON-WARBURTON (*Vice-President*), Arley Hall, Northwich.
 EDMOND CHESTER WATERS, Upton Park, Poole.
 FRANK G. WATNEY, 17, Pembroke Crescent, Bayswater, W.
 Rev. JAMES WEBB, M.A., Clifton, Brighouse.
 Lieut.-Colonel WESTON, Hunterstone House, West Kilbride, Ayrshire.
 WILLIAM H. WHITMORE, Boston, U.S.A.
 Miss WILLIAMS, Orchard Wyndham, Taunton.
 Rev. EDWARD WILTON, West Lavington, Devizes.
 R. H. WOOD, F.S.A., Crumpsall, Manchester.
 CHARLES H. L. WOODD, F.G.S., Roslyn, Hampstead.
 W. H. WRIGHT, Philadelphia.

PUBLICATIONS.

PUBLISHED.

No. I.

The Visitation of London, in 1568, by Cooke.

EDITED BY J. J. HOWARD, ESQ., F.S.A., AND G. J. ARMYTAGE, ESQ., F.S.A.

No. II.

**The Visitation of Leicestershire, in 1619, by Lennard
and Vincent.**

EDITED BY JOHN FETHERSTON, JUN., ESQ., F.S.A.

IN PROSPECT.

No. III.

The Visitation of Rutland in 1618.

The Visitation of Nottingham in 1614.

EDITED BY G. W. MARSHALL, ESQ., LL.M.

The Visitation of Oxford in 1574 and 1634.

TO BE EDITED BY W. H. TURNER, ESQ.

The Visitation of Devonshire in 1620.

TO BE EDITED BY THE REV. F. COLBY, B.D., FELLOW OF EXETER COLLEGE,
OXFORD.

The Visitation of Lincoln.

TO BE EDITED BY COLONEL CHESTER AND EDWARD PEACOCK, ESQ., F.S.A.

The Visitation of Cornwall in 1620.

The Visitation of London in 1633-4.

TO BE EDITED BY J. J. HOWARD, ESQ., F.S.A.

In compliance with Section 108 of the
Copyright Revision Act of 1976,
The Ohio State University Libraries
has produced this facsimile on permanent/durable
paper to replace the deteriorated original volume
owned by the Libraries. Facsimile created by
Acme Bookbinding, Charlestown, MA



2003

The paper used in this publication meets the
minimum requirements of the
American National Standard for Information
Sciences - Permanence for Printed Library
Materials,
ANSI Z39.48-1992.



